

4 Axes Motor Control IC with High Functions

MCX514 User's Manual

2014-08-01	Ver. 1.0
2014-12-15	Ver. 2.0
2015-02-01	Ver. 3.0
2015-04-17	Ver. 4.0
2015-10-15	Ver. 5.0
2015-12-09	Ver. 6.0
2016-08-17	Ver. 7.0
2017-01-17	Ver. 8.0
2017-05-09	Ver. 9.0
2017-09-13	Ver. 10.0

NOVA electronic

Prevent Electrostatic Discharge



ATTENTION: This IC is sensitive to electrostatic discharge, which can cause internal damage and affect normal operation. Follow these guidelines when you handle this IC:

- Touch a grounded object to discharge potential static.
- Wear an approved grounding wrist strap.
- Do not touch pins of this IC.
- Store this IC in appropriate static-safe packaging when not in use.

Safety Notice



WARNING: This IC is not designed or intended to be fail-safe, or for use in any application requiring fail-safe performance, such as in life-support or safety devices or systems that could lead to death, personal injury or severe property or environmental damage (individually and collectively, "critical applications"). Customer must be fully responsible for the use of this IC in critical applications.

Provide adequate design and operating safeguards in order to minimize risks associated with customer's applications when incorporating this IC in a system.

Compliance



ATTENTION: "Japanese Foreign Exchange and Foreign Trade Act" and other export-related laws and regulations must be observed and complied with. Do not use this IC for the purpose of the development of weapons such as mass destruction weapons and any military purposes. This IC shall not be used in equipment that manufacture, use and sale are prohibited by Japanese and foreign laws and regulations.

Before you begin



ATTENTION: Before using this IC, read this manual thoroughly to ensure correct usage within the scope of the specification such as the signal voltage, signal timing, and operation parameter values.

Installation of this IC



ATTENTION: This IC is provided in the form of a lead-free package. The installation conditions are different from those of the conventional lead-soldered IC. See Chapter 11 for the installation conditions of this IC.

About Reset



ATTENTION: Make sure to reset the IC when the power is on. This IC will be reset if RESETN signal is set to Low for more than 8 CLK cycles when a stable clock has been input. Please note that the IC will not be reset if the clock is not input.

Treatment of unused pins



ATTENTION: Make sure that unused input pins are connected to GND or VDD. If these pins are open, the signal level of pins will unstable and may cause malfunction.

Make sure that unused bi-directional pins are connected to VDD or GND through high impedance (about 10k~ 100 kΩ). If these pins are directly connected to GND or VDD, the IC may be damaged by overcurrent in case of such as a programming

Notes on S-curve acceleration/deceleration driving



ATTENTION: This IC is equipped with a function that performs decelerating stop. For a fixed pulse drive with S-curve deceleration of the symmetrical acceleration /deceleration. However, when the initial speed is set to an extremely low speed (10 or less), slight premature termination or creep may occur. Before using a S-curve deceleration drive, make sure that your system allows premature termination or

Technical Information



ATTENTION: Before using this IC, read "Appendix B Technical Information" on the last pages of this manual without fail because there are some important information.

The descriptions of this manual may change without notice because of the progress of the technologies, etc. Please download the up-date data from our website (<http://www.novaelec.co.jp/eng>) and/or ask us to supply you directly.

■ Terms and Symbols used in the Manual

Active	The function of a signal is the state of being enabled.
Drive	Action to output pulses for rotating a motor to the driver (drive unit) of a pulse type servo motor or stepping motor.
Fixed pulse drive	Drive that outputs specified pulses. Three types of drives: relative position drive, counter relative position drive and absolute position drive are available.
Continuous pulse drive	Drive that outputs pulses up to infinity unless a stop factor becomes active.
CW	Clockwise direction (abbreviation of clockwise)
CCW	Counter-clockwise direction (abbreviation of counter-clockwise)
Interpolation segment	Each interpolation driving that comprises continuous interpolation.
Jerk	Acceleration increasing/decreasing rate per unit time. This term includes a decreasing rate of acceleration (=Jerk).
Deceleration increasing rate	Deceleration increasing/decreasing rate per unit time. This term includes a decreasing rate of deceleration.
2's complement	2's complement is used to represent negative numbers in binary. [Example] In 16-bit length, -1 is FFFFh, -2 is FFFEh, -3 is FFFDh, ... -32768 is 8000h.
Creep	In deceleration of acceleration/ deceleration fixed pulse driving, output of specified driving pulses is not completed even if the speed reaches the initial speed and the rest of driving pulses is output at the initial speed (= Creep).
Premature termination	In deceleration of acceleration/ deceleration fixed pulse driving, output of specified driving pulses is completed and driving is terminated before the speed reaches the initial speed. This is a reverse behavior of creep.
↑	The rising edge of when a signal changes its level from Low to Hi.
↓	The falling edge of when a signal changes its level from Hi to Low.
n○○○○	The signal name of each axis X, Y, Z and U is written as n○○○○. This “n” stands for X, Y, Z or U.
nPIOm	PIO signal of each axis X, Y, Z and U is written as nPIOm. This “n” stands for X, Y, Z or U, and “m” stands for 0~7 of PIO0~PIO7.
SYNCm	Synchronous action set SYNC0~SYNC3 is written as SYNCm. This “m” stands for 0~3 of SYNC0~SYNC3.
MRm	Multi-purpose register MR0~MR3 is written as MRm. This “m” stands for 0~3 of MR0~MR3.

1. OUTLINE	- 1 -
1.1 The Main Features of Functions	- 1 -
1.2 Functional Block Diagram	9
1.3 Specification Table	11
2. The Descriptions of Functions	15
2.1 Fixed Pulse Driving and Continuous Pulse Driving	15
2.1.1 Relative Position Driving	15
2.1.2 Absolute Position Driving	16
2.1.3 Counter Relative Position Driving	16
2.1.4 Continuous Pulse Driving	18
2.2 Acceleration and Deceleration	20
2.2.1 Constant Speed Driving	20
2.2.2 Trapezoidal Driving [Symmetrical]	21
2.2.3 Non-Symmetrical Trapezoidal Acceleration	23
2.2.4 S-curve Acceleration/Deceleration Driving [Symmetrical]	25
2.2.5 Non-symmetrical S-Curve Acceleration/Deceleration	31
2.2.6 Pulse Width and Speed Accuracy	33
2.3 Position Control	34
2.3.1 Logical Position Counter and Real position Counter	34
2.3.2 Position Comparison	34
2.3.3 Software Limit	34
2.3.4 Position Counter Variable Ring	35
2.4 Multi-Purpose Register	35
2.4.1 Comparative Object and Comparison Condition	36
2.4.2 Usage of Comparison Result	37
2.4.3 Load / Save of Parameters by Synchronous Action	40
2.5 Automatic Home Search	41
2.5.1 Operation of Each Step	42
2.5.2 Deviation Counter Clearing Signal Output	45
2.5.3 Timer Between Steps	45
2.5.4 Setting a Search Speed and a Mode	46
2.5.5 Execution of Automatic Home Search and the Status	50
2.5.6 Errors Occurring at Automatic Home Search	51
2.5.7 Notes on Automatic Home Search	52
2.5.8 Examples of Automatic Home Search	53
2.6 Synchronous Action	59
2.6.1 Activation Factor	61
2.6.2 Action	63

2.6.3	Synchronous Action Settings	67
2.6.4	Synchronous Action Execution	70
2.6.5	Interrupt by Synchronous Action	70
2.6.6	Examples of Synchronous Action	71
2.6.7	Synchronous Action Delay Time	76
2.7	Split Pulse	78
2.7.1	Split Pulse Setting	78
2.7.2	Start / Termination of Split Pulse	79
2.7.3	Split Pulse in Synchronous Action	80
2.7.4	Interrupt by Split Pulse	80
2.7.5	Notes on Split Pulse	80
2.7.6	Examples of Split Pulse	81
2.8	General Purpose Input / Output Signal	87
2.8.1	nPIOm Signal	87
2.8.2	Other Input Signals	90
2.9	Timer	91
2.9.1	Timer Operation	91
2.9.2	Timer Setting	92
2.9.3	Timer-Start / Timer-Stop	92
2.9.4	Timer and Synchronous Action	92
2.9.5	Timer Operating State and Current Timer Value Reading	92
2.9.6	Interrupt by Timer	92
2.9.7	Examples of Timer	93
2.10	Interrupt	96
2.10.1	Interrupt from X, Y, Z and U axes	96
2.10.2	Interrupt during Continuous Interpolation	97
2.11	Input Signal Filter	98
2.11.1	Setting of Input Signal Filter Function	99
2.11.2	Example of Setting Input Signal Filters	100
2.12	Other Functions	101
2.12.1	Driving By External Pulses	101
2.12.2	Pulse Output Type Selection	104
2.12.3	Encoder Pulse Input Type Selection	105
2.12.4	Hardware Limit Signals	106
2.12.5	Interface to Servo Motor Driver	107
2.12.6	Emergency Stop	107
2.12.7	Status Output	108

3. Interpolation 109

3.1	Linear Interpolation	112
-----	----------------------------	-----

3.1.1	Maximum Finish Point	112
3.1.2	Examples of Linear Interpolation	112
3.2	Circular Interpolation	114
3.2.1	The Finish Point Checking of Circular Interpolation	115
3.2.2	Toggle of Interpolation Axis	115
3.2.3	The Example for CW Circular Interpolation.....	115
3.3	Helical Interpolation	116
3.3.1	Interpolation Axis and Short Axis Pulse Equalization Mode Setting	117
3.3.2	Interpolation Speed Setting	117
3.3.3	Helical Rotation Number Setting.....	117
3.3.4	Position Data Setting.....	118
3.3.5	Helical Calculation Execution	119
3.3.6	Helical Interpolation Execution	120
3.3.7	Current Helical Rotation Number Reading.....	120
3.3.8	Position Drift in Helical Interpolation	121
3.3.9	Examples of Helical Interpolation	122
3.4	Bit Pattern Interpolation	125
3.4.1	Designation of Interpolation Axis	126
3.4.2	Interpolation Speed Setting	126
3.4.3	Bit Pattern Data Writing.....	126
3.4.4	Write of Interpolation Driving Command	127
3.4.5	Termination of Interpolation	127
3.4.6	Check Available Space of Pre-buffer	128
3.4.7	Interruption of Interpolation Driving	128
3.4.8	Example of Bit Pattern Interpolation	129
3.5	Constant Vector Speed.....	130
3.5.1	Constant Vector Speed Setting.....	131
3.6	Short Axis Pulse Equalization	132
3.6.1	Short Axis Pulse Equalization Setting	132
3.6.2	Notes on Using Short Axis Pulse Equalization.....	133
3.7	Continuous Interpolation.....	134
3.7.1	How to Perform Continuous Interpolation	135
3.7.2	Continuous Interpolation by Using Interrupt.....	137
3.7.3	Errors during Continuous Interpolation	138
3.7.4	Attention for Continuous Interpolation	138
3.7.5	Example of Continuous Interpolation.....	139
3.8	Acceleration / Deceleration Control in Interpolation.....	141
3.8.1	Acceleration / Deceleration for Linear Interpolation	141
3.8.2	Acceleration / Deceleration for Circular Interpolation and Bit Pattern Interpolation	141

3.8.3	Acceleration / Deceleration for Continuous Interpolation	143
3.9	Single-step interpolation	144
3.9.1	Command Controlled Single-step Interpolation	144
3.9.2	External Signal Controlled Single-step Interpolation.....	145
3.9.3	Attention for Single-step Interpolation.....	145
3.10	Multichip Interpolation.....	146
3.10.1	Execution Procedure	147
3.10.2	Stop of Interpolation Driving	149
3.10.3	Continuous Interpolation	149
3.10.4	Notes for Multichip Interpolation	149
3.10.5	Examples of Multichip Interpolation	150

4.I2C Serial Bus 154

4.1	Pins used in I2C Bus Mode	154
4.1.1	Pull-up Resistor (Rp).....	154
4.1.2	I2CRSTN Reset.....	155
4.2	I2C Bus Transmitting and Receiving.....	155
4.2.1	Writing Operation	156
4.2.2	Reading Operation	157
4.2.3	Notes on Using I2C Serial Bus	159
4.2.4	Connection Example	159
4.2.5	Control Example.....	160

5.Pin Assignments and Signal Description..... - 163 -

5.1	Pin Assignments	- 163 -
5.2	Signal Description.....	- 164 -
5.3	Input/Output Logic	- 170 -
5.4	Remarks of Logic Design	- 171 -

6.Register - 172 -

6.1	Register Address by 16-bit Data Bus.....	- 172 -
6.2	Register Address by 8-bit Data Bus.....	- 174 -
6.3	Register Address by I2C Serial Interface Bus Mode.....	174
6.4	Command Register: WR0	- 175 -
6.5	Mode Register1: WR1	- 175 -
6.6	Mode Register2: WR2	- 176 -
6.7	Mode Register3: WR3	- 177 -
6.8	Output Register: WR4	- 179 -
6.9	Output Register: WR5	- 180 -
6.10	Data Register: WR6/WR7	- 180 -

6.11	Main Status Register: RR0	- 181 -
6.12	Status Register 1: RR1	- 182 -
6.13	Status Register 2: RR2	- 183 -
6.14	Status Register 3: RR3	- 184 -
6.15	PIO Read Register 1: RR4	- 186 -
6.16	PIO Read Register 2: RR5	- 186 -
6.17	Data-Read Register: RR6 / RR7.....	- 186 -

7.Commands - 187 -

7.1	Command Lists.....	- 187 -
7.2	Commands for Writing Data	191
7.2.1	Jerk Setting.....	191
7.2.2	Deceleration Increasing Rate Setting	191
7.2.3	Acceleration Setting	192
7.2.4	Deceleration Setting	192
7.2.5	Initial Speed Setting	193
7.2.6	Drive Speed Setting	193
7.2.7	Drive pulse number / Finish point setting.....	194
7.2.8	Manual Decelerating Point Setting	194
7.2.9	Circular Center Point Setting	195
7.2.10	Logical Position Counter Setting	195
7.2.11	Real Position Counter Setting	195
7.2.12	Software Limit + Setting	195
7.2.13	Software Limit – Setting	196
7.2.14	Acceleration Counter Offsetting.....	196
7.2.15	Logical Position Counter Maximum Value Setting.....	196
7.2.16	Real Position Counter Maximum Value Setting.....	196
7.2.17	Multi-Purpose Register 0 Setting	197
7.2.18	Multi-Purpose Register 1 Setting	197
7.2.19	Multi-Purpose Register 2 Setting	197
7.2.20	Multi-Purpose Register 3 Setting	198
7.2.21	Home Search Speed Setting	198
7.2.22	Speed Increasing / Decreasing Value Setting.....	198
7.2.23	Timer Value Setting	199
7.2.24	Split Pulse Setting 1	199
7.2.25	Split Pulse Setting 2	199
7.2.26	Interpolation / Finish Point Maximum Value Setting	200
7.2.27	Helical rotation number setting	200
7.2.28	Helical calculation setting	200
7.3	Commands for Writing Mode	201

7.3.1	Multi-Purpose Register Mode Setting	201
7.3.2	PIO Signal Setting 1	202
7.3.3	PIO Signal Setting 2 · Other Settings	204
7.3.4	Automatic Home Search Mode Setting 1	205
7.3.5	Automatic Home Search Mode Setting 2	206
7.3.6	Input Signal Filter Mode Setting	208
7.3.7	Synchronous Action SYNC0, 1, 2, 3 Setting	209
7.3.8	Interpolation Mode Setting	211
7.4	Commands for Reading Data	213
7.4.1	Logical Position Counter Reading	213
7.4.2	Real Position Counter Reading	213
7.4.3	Current Drive Speed Reading	213
7.4.4	Current Acceleration / Deceleration Reading	214
7.4.5	Multi-Purpose Register 0 Reading	214
7.4.6	Multi-Purpose Register 1 Reading	214
7.4.7	Multi-Purpose Register 2 Reading	214
7.4.8	Multi-Purpose Register 3 Reading	215
7.4.9	Current Timer Value Reading	215
7.4.10	Interpolation / Finish point maximum value Reading	215
7.4.11	Current Helical Rotation Number Reading	215
7.4.12	Helical Calculation Value Reading	216
7.4.13	WR1 Setting Value Reading	216
7.4.14	WR2 Setting Value Reading	216
7.4.15	WR3 Setting Value Reading	216
7.4.16	Multi-Purpose Register Mode Setting Reading	217
7.4.17	PIO Signal Setting 1 Reading	217
7.4.18	PIO Signal Setting 2 / Other Settings Reading	217
7.4.19	Acceleration Setting Value Reading	218
7.4.20	Initial Speed Setting Value Reading	218
7.4.21	Drive Speed Setting Value Reading	218
7.4.22	Drive Pulse Number / Finish Point Setting Value Reading	218
7.4.23	Split Pulse Setting 1 Reading	219
7.4.24	General Purpose Input Value Reading	219
7.5	Driving Commands	220
7.5.1	Relative Position Driving	220
7.5.2	Counter Relative Position Driving	221
7.5.3	+ Direction Continuous Pulse Driving	221
7.5.4	- Direction Continuous Pulse Driving	221
7.5.5	Absolute Position Driving	222

7.5.6	Decelerating Stop.....	222
7.5.7	Instant Stop.....	222
7.5.8	Direction Signal + Setting.....	222
7.5.9	Direction Signal – Setting.....	223
7.5.10	Automatic Home Search Execution.....	223
7.6	Interpolation Commands.....	224
7.6.1	1-axis Linear Interpolation Driving (Multichip).....	224
7.6.2	2-axis Linear Interpolation Driving.....	224
7.6.3	3-axis Linear Interpolation Driving.....	224
7.6.4	4-axis Linear Interpolation Driving.....	225
7.6.5	CW Circular Interpolation Driving.....	225
7.6.6	CCW Circular Interpolation Driving.....	225
7.6.7	2-Axis Bit Pattern Interpolation Driving.....	225
7.6.8	3-Axis Bit Pattern Interpolation Driving.....	226
7.6.9	4-Axis Bit Pattern Interpolation Driving.....	226
7.6.10	CW Helical Interpolation Driving.....	226
7.6.11	CCW Helical Interpolation Driving.....	226
7.6.12	CW Helical Calculation.....	227
7.6.13	CCW Helical Calculation.....	227
7.6.14	Deceleration Enabling.....	227
7.6.15	Deceleration Disabling.....	227
7.6.16	Interpolation Interrupt Clear / Single-step Interpolation.....	228
7.7	Synchronous Action Operation Commands.....	229
7.7.1	Synchronous Action Enable Setting.....	229
7.7.2	Synchronous Action Disable Setting.....	230
7.7.3	Synchronous Action Activation.....	230
7.8	Other Commands.....	231
7.8.1	Speed Increase.....	231
7.8.2	Speed Decrease.....	231
7.8.3	Deviation Counter Clear Output.....	232
7.8.4	Timer-Start.....	232
7.8.5	Timer-Stop.....	232
7.8.6	Start of Split Pulse.....	232
7.8.7	Termination of Split Pulse.....	233
7.8.8	Drive Start Holding.....	233
7.8.9	Drive Start Holding Release.....	233
7.8.10	Error / Finishing Status Clear.....	233
7.8.11	RR3 Page 0 Display.....	234
7.8.12	RR3 Page 1 Display.....	234

7.8.13	Maximum finish point clear	234
7.8.14	NOP	234
7.8.15	Command Reset	235

8. Connection Examples 236

8.1	Example of 16-bit Bus Mode Connection	236
8.2	Example of Connection in I2C Bus Mode	237
8.3	Connection Example	238
8.4	Pulse Output Interface	238
8.5	Connection Example for Input Signals.....	239
8.6	Connection Example for Encoder	239

9. Example Program..... 240

10. Electrical Characteristics..... 253

10.1	DC Characteristics.....	253
10.2	AC Characteristics.....	254
10.2.1	Clock.....	254
10.2.2	Read / Write Cycle	254
10.2.3	CLK / Output Signal Timing	255
10.2.4	Input Pulses	255
10.2.5	General Purpose Input / Output Signals (nPIO7~0)	256
10.2.6	Split Pulse.....	256
10.2.7	I ² C Serial Bus (At fast mode.).....	257

11. Timing of Input / Output Signals 258

11.1	Power-On Reset	258
11.2	Timing of drive start / finish.....	258
11.3	Interpolation Driving	259
11.4	Start Driving after Hold Command.....	259
11.5	Instant Stop	259
11.6	Decelerating Stop	260
11.7	Detailed Timing of Split Pulse	260

12. Package Dimensions 261

13. Storage and Recommended Installation

Conditions 262

13.1	Storage of this IC.....	262
13.2	Standard Installation Conditions by Soldering Iron	262
13.3	Standard Installation Conditions by Solder Reflow	262

Appendix A Calculation Formula of Acceleration/Deceleration Drive	A-1
A-1 Case of Trapezoidal Acceleration/Deceleration Driving	A-1
A-2 Case of S-curve Acceleration/Deceleration Driving	A-2
Appendix B Parameter Calculation Formula when Input Clock except 16MHz	B-1
Appendix C Differences with MCX300 series	C-1

■ Revision History

1st edition	2014-08-01	Newly created.
2nd edition	2014-12-15	<ul style="list-style-type: none"> •Correction of the following errors 1.3 Specification Table over limit signal name 3. Interpolation each interpolation speed 7.4.24 General Purpose Input Value Reading data range of general purpose input value reading 9. Example Program description of interpolation command functions
3rd edition	2015-02-12	<ul style="list-style-type: none"> • Correction of the following errors about the finish point range of interpolation 3.1 Linear Interpolation range of coordinates 3.2 Circular Interpolation range of center and finish point coordinates 3.6 Short Axis Pulse Equalization settable range of center and finish points 7.1 Command Lists ■ Commands for Writing Data data range of <ul style="list-style-type: none"> • Drive pulse number/Finish point setting • Circular center point setting • Interpolation / Finish point maximum value setting ■ Commands for Reading Data data range of <ul style="list-style-type: none"> • Interpolation / Finish point maximum value reading • Drive pulse number / Finish point setting value reading 7.2.7 Drive pulse number / Finish point setting data range 7.2.9 Circular Center Point Setting data range 7.2.26 Interpolation / Finish Point Maximum Value Setting data range 7.4.10 Interpolation / Finish point maximum value Reading data range 7.4.22 Drive Pulse Number / Finish Point Setting Value Reading data range • Correction of the following error 5.2 Signal Description VDD Pin No.
4th edition	2015-04-17	<ul style="list-style-type: none"> • Correction of the following errors about triangle form prevention 2.2.2 Triangle form prevention of trapezoidal driving 2.2.3 Triangle form prevention of non-symmetrical trapezoidal driving • Correction of the following errors about changing drive speed during interpolation driving 3. Interpolation Set interpolation speed 3.7.1 How to Perform Continuous Interpolation 3.7.4 Attention for Continuous Interpolation 7.2.6 Drive Speed Setting • Correction of the following errors about short axis pulse equalization 3.6.2 Notes on Using Short Axis Pulse Equalization 3.7.4 Attention for Continuous Interpolation • Correction of the following errors 5.2 Signal Description Description (D15~D0) 7.4.24 General Purpose Input Value Reading
5th edition	2015-10-15	<ul style="list-style-type: none"> •Add the following about EMGN signal input signal. 2.11.1 table2.11-1, Add the setting of ※EMGN signal 2.12.6 Emergency stop, Add “4 axes(all axes)” 5.2 Signal description, Add “all axes” about EMGN 1.3 Temperature for driving→Operating Temperature Power Voltage for driving→Operating Power Voltage 10.1 Ambient Temperature→Operating temperature Ta→TOPR
6th edition	2015-12-09	<ul style="list-style-type: none"> 2.8.1 Add [Note] at the end of nPIOm signal 5.3 Bidirectional B 50KΩ→ 50KΩ(Typ.) 5.3 Bidirectional C 100KΩ→ 100KΩ(Typ.) 5.4 d.De-coupling Capacitor two or three → three or four

7th edition	2016-8-17	Change software limit setting range -2,147,483,648~2,147,483,647 → -2,147,483,647~2,147,483,647
		Modify as follows. 2.2.3 Non-Symmetrical Trapezoidal Acceleration · non-symmetry linear acceleration / deceleration driving → non-symmetry linear automatic acceleration / deceleration driving · In non-symmetry linear acceleration / deceleration driving, when acceleration > deceleration (Fig. 2.2-7), the following condition is applied to the ratio of acceleration and deceleration → In non-symmetry linear automatic acceleration / deceleration driving, when acceleration > deceleration (Fig. 2.2-7), the following condition is applied to the ratio of acceleration and deceleration. In this case, set drive speed 4Mpps or less.
		Correction of the following error WR6 ← 4BC5h Write ; Circle finish point Y : 19397 → WR6 ← 4BABh Write ; Circle finish point Y : 19371
		Correction of the following error 3.7.1 How to Perform Continuous Interpolation (7) Error check For more details of the error bit of RR0 register, see chapter 6.13. → For more details of the error bit of RR0 register, see RR2 register in chapter 6.13.
		Correction of the following error 5.1 Pin assignment See chapter 10 → See chapter 12
		Correction of the following error 5.4 Remarks of Logic Design a. About TEST1, 2 Pins Make sure that TEST1, 2 (141, 142) pins are connected to GND → Make sure that TEST1, 2 (141, 142) pins are open or connected to GND
		Modify as follows. 7.2.14 Acceleration Counter Offsetting See chapter 2.1 for details of acceleration counter offsetting. → See chapter 2.1 [■ Offset Setting for Acceleration/Deceleration Driving] for details of acceleration counter offsetting.
		Correction of the following error 7.3.7 Synchronous Action SYNC0, 1, 2, 3 Setting D14~13 AXIS3~1 → D14~12 AXIS3~1
		Add the following sentence 9. Example Program · Write functions for WR register int WriteReg5(unsigned short Data){ // Writes into WR5 register return(WriteReg((volatile unsigned short*)(REG_ADDR + MCX514_WR5), Data)); }
		Modify as follows. 2.6.4 Synchronous Action Execution Synchronous action activate command(A1h~Ah) → Synchronous action activate command(A1h~AFh)
		Modify as follows. 3.4 Bit pattern interpolation (Image of bit pattern) YPP(Y -direction pulse) → YPM(Y -direction pulse)
		Modify as follows. 3.6 Short axis pulse equalization Symbols of Table3.6-1 V, A, D, P, C → DV, AC, DC, TP, CP
		Modify as follows. 3.9.1 Command Controlled Single-step Interpolation Single-step interpolation command → Interpolation step command
		Modify as follows. 6.7 WR3 [Table of D9,8 D3(PIMD0) → D8(PIMD0)
		Modify as follows. 7.1 Command lists Code 08/Circular center point setting/CT → Code 08/ Circular center point setting /CP
Modify as follows. 7.2.9 Circular center point setting CT → CP		

		<p>Modify as follows. 7.3.7 Synchronous Action SYNC0, 1, 2, 3 Setting D3~0 PREV3~0 → D3~0 PRV3~0</p> <p>Modify as follows. 7.4.4 Current Acceleration / Deceleration Reading [Note] • In linear acceleration / deceleration driving (symmetrical), the acceleration setting value will always be read out during the driving. • In S-curve acceleration / deceleration driving, the current acceleration / deceleration reading value will be invalid at the constant speed area. → • At constant speed area in linear acceleration / deceleration driving (symmetrical), the acceleration setting value will always be read out. • At constant speed area in S-curve acceleration / deceleration driving, the read value will be invalid.</p> <p>Modify as follows. 8.1 Example of 16-bit / 8-bit Bus Mode Connection → 8.1 Example of 16-bit Bus Mode Connection</p> <p>8.1 Example of 16-bit Bus Mode Connection Add connection of BUSMODE and +3.3V to MCX514 side.</p>
8th edition	2017-1-7	<p><Further Note> *11 Change the speed of helical interpolation 2Mpps→250Kpps</p> <p>2.2.3 Non-Symmetrical Trapezoidal Acceleration Delete as follows. [Note] • Though the triangle form prevention function works in non-symmetrical linear acceleration / deceleration driving, if changing a drive speed during the driving, set the triangle form prevention function to disable (WR3 / D13 : 1).</p> <p>2.6.2 Action Description 5: Drive decelerating stop / Instant stop Changed as follows. When interpolation driving is stopped by this action, be sure to written error/finishing status clear command (79h) to the interpolation axis. →When interpolation driving is stopped by this action, be sure to written error/finishing status clear command (79h) to the interpolation axis after checking that interpolation drive stops.</p> <p>2.6.6 Examples of Synchronous Action Example 1,2 and 3 【Program Example】 2.7.6 Examples of Split Pulse Example 2, 3, and 4 【Program Example】 2.9.7 Examples of Timer Example 1 and 2 【Program Example】 7.3.7 Synchronous Action SYNC0, 1, 2, 3 Setting Modified as follows. PREV3~0→PRV3~0</p> <p>3.Interpolation Modified as follows. Speed of helical interpolation 2Mpps→250Kpps</p> <p>Deleted [Note] The drive speed cannot be changed during interpolation driving</p> <p>Add as follows. Speed changing during interpolation driving Speed can be changed during interpolation driving by synchronous action. Set drive speed that the user wants to change to multi-purpose register. For synchronous action, see chapter 2.6. [Note] When short axis pulse equalization mode is set, set 8 times speed value of which the user wants to operate. For instance, if the user wants to operate at 1,000pps, set “8,000”. Speed value can be set within the range of “1~8,000,000”.</p> <p>Changed as follows. 3.3.1 Interpolation Axis Setting→ 3.3.1 Interpolation Axis and Short Axis Pulse Equalization Mode Setting</p> <p>Add as follows. When executing interpolation drive, set “short axis pulse equalization mode” enable (see chapter 3.6.). Set D8 bit of WR6 register as 1.</p> <p>3.3.2 Interpolation Speed Setting Add as follows For the setting of helical interpolation, please see chapter 3.6 Short Axis Pulse Equalization. The range of setting speed for helical interpolation is 1PPS~250KPPS.</p> <p>3.3.10 Notes on Helical Interpolation Add as follows. WR6 ← 4BABh Write ; Circle finish point Y : 19371 WR7 ← 0000h Write</p>

		WR0 ← 0206h Write
		<p>3.7.3 Errors during Continuous Interpolation ■ Data writing error Changed as follows This error can be cleared by issuing error/finishing status clear command (79h) to all the interpolation axes.→ This error can be cleared by issuing error/finishing status clear command (79h) to all the interpolation axes after checking that interpolation drive stops.</p> <p>4. I2C Serial Bus Changed as follows. Fast mode plus→Fast plus mode</p> <p>5.2 Signal Description Modified as follows. External Operation– (EXPP) is – direction drive starting → External Operation– (EXPM) is – direction drive starting</p> <p>6.11 Main Status Register: RR0 D7~4 n-ERR Changed as follows. be sure to clear the error by the error/finishing status clear command (79h).→ be sure to clear the error by the error/finishing status clear command (79h) after checking that interpolation drive stops.</p> <p>6.13 Status Register 2: RR2 be sure to clear the error bit to 0 by error/finishing status clear command (79h).→ be sure to clear the error bit to 0 by error/finishing status clear command (79h) after checking that interpolation drive stops.</p> <p>[Note] Changed as follows. be sure to write the error/finishing status clear command (79h) after checking that interpolation drive stops. Otherwise, interpolation driving will not work properly after that.→ be sure to write the error/finishing status clear command (79h).</p> <p>7.2.6 Drive Speed Setting [Note] Changed as follows. The drive speed cannot be changed during interpolation driving. →When changing the drive speed during interpolation driving, it can be changed by synchronous action.</p> <p>7.8.10 Error / Finishing Status Clear Changed as follows. This command is also used to clear the error generated in interpolation driving. →This command is used when an error occurs in interpolation driving after checking that interpolation drive stops.</p> <p>9. Example Program Modified the details of program.</p> <p>10. Electrical Characteristics ■ DC Characteristics Changed as follows. (Ta= -40 ~ +85°C, VDD = 3.3V±0.3V)→ (TOPR= -40 ~+85°C, VDD = 3.3V±0.3V)</p> <p>10.2.7 I2C Serial Bus → 10.2.7 I2C Serial Bus (At fast mode.)</p> <p>Appendix C Differences with MCX300 series item6 Changed as follows However, when an error occurs during interpolation driving, it is necessary to write error/finishing status clear command (79h) after checking that interpolation drive stops.</p>
9th edition	2017-5-9	<p>2.1.4 Continuous Pulse Driving <Speed Change by Speed Increase / Decrease Command > Changed as follows. When changing a drive speed during the driving, set the triangle form prevention function as disable (WR3/D13 : 1). → When changing a drive speed during fixed pulse driving, set the triangle form prevention function as disable (WR3/D13 : 1).</p> <p>Add 3.3.9 Notes on Helical Interpolation Helical interpolation can be executed for constant speed driving only. It cannot be executed for acceleration/deceleration driving and continuous interpolation driving. Speed range of helical interpolation is 1~250Kpps. Make sure to use with short axis pulse equalization mode. For helical interpolation, if the start and finish points of a circular arc are not on X or Y-axis, the finish points of the both axes may deviate by ±1 pulse. When one rotation or more are executed in helical interpolation driving, this deviate may accumulate. When the start and finish points of a circular arc are on X or Y-axis, this deviate does not occur. Set the feed amount of Z and U-axis less than the total output pulse of circular interpolation which is set for helical interpolation.</p> <p>7.2.6 Drive Speed Setting Changed as follows. In fixed pulse symmetrical trapezoidal driving, the drive speed can be changed during the driving, however the frequent changes of drive speed may generate premature termination or creep. → In fixed pulse symmetrical trapezoidal driving, the drive speed can be changed during the</p>

		<p>driving, set triangle form prevention function to disable (WR3/D13:1). The frequent changes of drive speed also may generate premature termination or creep.</p> <p>7.8.1 Speed Increase Changed as follows. This command can be used during continuous pulse driving and cannot be used during fixed pulse driving. If this command is used frequently during fixed pulse driving, premature termination or creep may occur at the termination of driving. → This command can be used during continuous pulse driving. If this command is used frequently during fixed pulse driving, premature termination or creep may occur at the termination of driving.</p> <p>Add as follows [Note] When changing a drive speed during fixed pulse driving, set the triangle form prevention function to disable (WR3 / D13 : 1).</p> <p>7.8.2 Speed Decrease Changed as follows. This command can be used during continuous pulse driving and cannot be used during fixed pulse driving. If this command is used frequently during fixed pulse driving, premature termination or creep may occur at the termination of driving. → This command can be used during continuous pulse driving. If this command is used frequently during fixed pulse driving, premature termination or creep may occur at the termination of driving.</p> <p>Add as follows [Note] When changing a drive speed during fixed pulse driving, set the triangle form prevention function to disable (WR3 / D13 : 1).</p> <p>9.Example Program Add Circular center point setting</p>
<p>10th edition</p>	<p>2017-9-13</p>	<p>3.5 Constant vector speed Changed as follows 3-axis simple constant vector speed mode is available for 3-axis linear interpolation, where the speed deviation is improved by setting 1/1.414 times pulse cycle when pulses of any 2 axes among 3 axes are output, and improved by setting 1/1.732 times pulse cycle when pulses of all 3 axes are output. →3-axis simple constant vector speed mode is available for 3-axis linear interpolation, where the speed deviation is improved by setting 1.414 times pulse cycle when pulses of any 2 axes among 3 axes are output, and improved by setting 1.732 times pulse cycle when pulses of all 3 axes are output.</p> <p>9.Example Program Modify the part of “Performs Automatic Home search using a home signal” as follows. Acceleration : 1000→95000 Initial speed : 100→1000 Speed of Step1 and 4. : 1000→20000</p>

1. OUTLINE

1.1 The Main Features of Functions

MCX514 is a 4-axis motion control IC that has improved greatly in functions of previous IC such as MCX314As / MCX314AL.

As the interpolation functions, it provides the existing linear interpolation, circular interpolation and bit pattern interpolation, in addition, it has the helical interpolation function that works to move Z-axis in a vertical direction, synchronizing with the circular interpolation on the XY plane.

MCX500 series motion control IC has no multiple of speed (speed range-free). This enables us to freely set and vary the drive speed linearly from 1 pps up to 8 Mpps in increments of 1pps without changing the range.

MCX514 can be connected to a host CPU with either 8-bit or 16-bit bus, and I²C serial interface bus. It can also be connected to a CPU without a parallel bus.

■ Helical Interpolation

MCX514 is capable of performing helical interpolation in addition to the existing linear interpolation and circular interpolation. Helical interpolation operates to move another axis in synchronization with the circular interpolation in the XY plane (orthogonal coordinates). The figure shown below is an example to move Z-axis in the + direction, corresponding to the circular interpolation on the XY plane. The figure 1.1-1 a. illustrates the helical interpolation under one rotation, and the figure 1.1-1 b. illustrates the helical interpolation in a plurality of rotations. MCX514 can perform both interpolation.

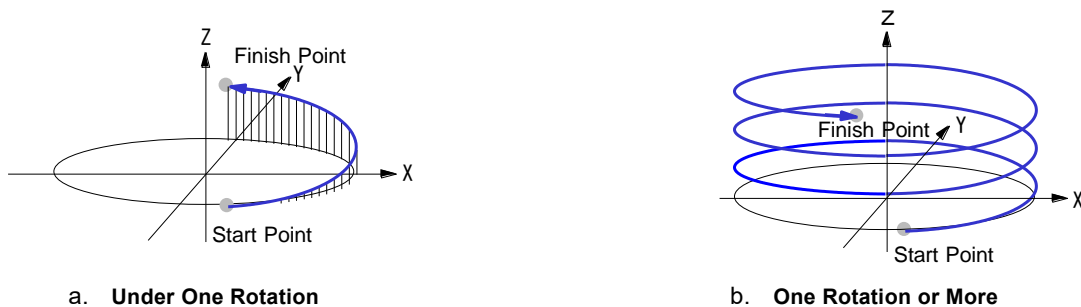

Fig. 1.1-1 Example of Helical interpolation

As an application of helical interpolation, it is possible to operate normal control that rotates another axis by a constant angle corresponding to the circular interpolation on the XY plane. The figure 1.1-2 shows an example of the operation that an object such as a camera or nozzle on a pedestal is directed to the center of circular interpolation, mounting a rotating axis in the pedestal that performs circular interpolation on the XY plane.

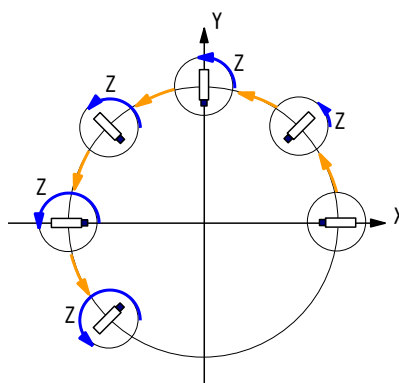

Fig. 1.1-2 Example of Normal Control of Z axis in XY axes Circular Interpolation

8 Stages of Pre-Buffer for Continuous Interpolation

MCX514 is equipped with 8 stages of pre-buffer register that stores finish point data (and others) in each segment, in order to handle continuous interpolation driving at high-speed.

In the case of the previous MCX314A having only 1 stage of pre-buffer, when performing continuous interpolation, driving time of each interpolation segment must be longer than setting time of position data for next segment. Therefore, minimum drive pulses of each segment are restricted depend on interpolation drive speed. For instance, when setting time of data to CPU is $T_{DS}=80 \mu \text{ sec}$ and interpolation drive speed is $V=100\text{Kpps}$, minimum drive pulses are required at least 8 pulses or more.

MCX514 increases pre-buffer to 8 stages and improves the restriction efficiently. When performing continuous interpolation as shown in the right figure, and when there is a short segment such as Seg3, if the average driving time of 8 segments including Seg3 is longer than setting time of position data for next segment, continuous interpolation can be performed.

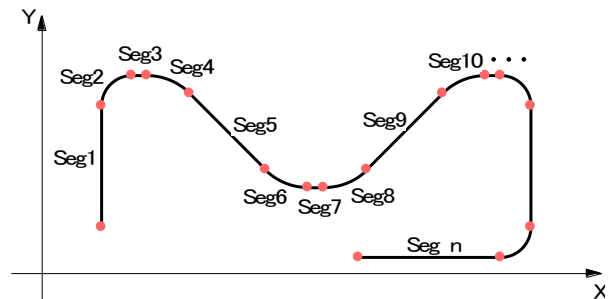

Fig. 1.1-3 Example of Continuous Interpolation

Multichip Interpolation

The user can perform multiple axes linear interpolation of 5 axes or more by connecting several MCX514 chips. Connect each chip by using 8 multichip signal lines in parallel.

In multiple axes linear interpolation, the maximum values to the finish points of all axes that perform interpolation are required for interpolation calculation. However, MCX514 does not need to set these maximum values. When a host CPU writes finish point data of each axis into IC respectively, the data will be sent to each IC through the multichip signal line, and then the maximum value of finish point will be calculated automatically in IC.

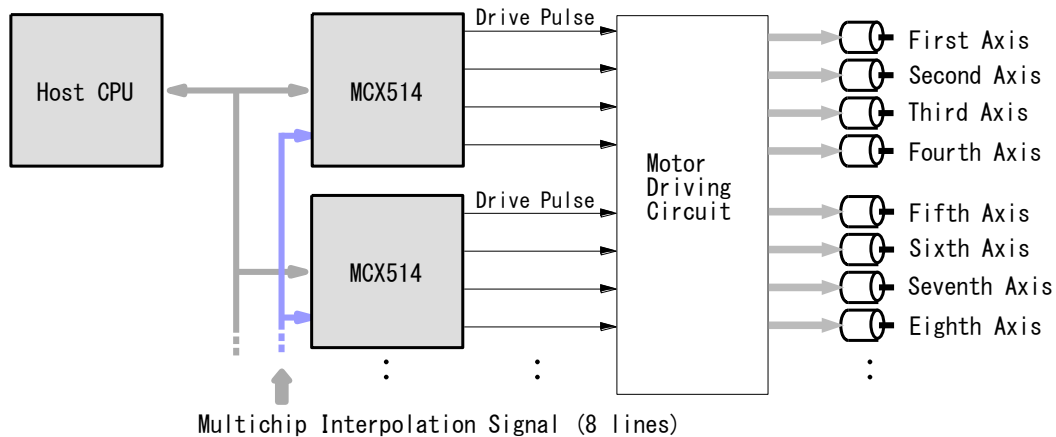

Fig. 1.1-4 Example of Multichip Interpolation

Short Axis Pulse Equalization Mode for Interpolation

In interpolation driving, all of axes that perform interpolation do not always output drive pulses at regular intervals during driving. As shown in the figure below, in 2-axis linear interpolation, the axis (long axis) that has longer moving distance (pulse) outputs pulses continuously; however, the axis (short axis) that has shorter one sometimes outputs and sometimes does not output pulses depending on the result of interpolation calculation, and these uneven pulses could be a problem. When performing interpolation in a stepper motor, if the user tries to perform interpolation at high-speed as well as independent driving, the vibration of a short axis is increased due to these thinning-out pulses and may step out. MCX514 can improve this problem with the function: short axis pulse equalization mode. Even in the axis has shorter moving distance, it can output drive pulses as equal as possible. And if this function is used in combination with constant vector speed mode, it will increase the accuracy of constant vector speed.

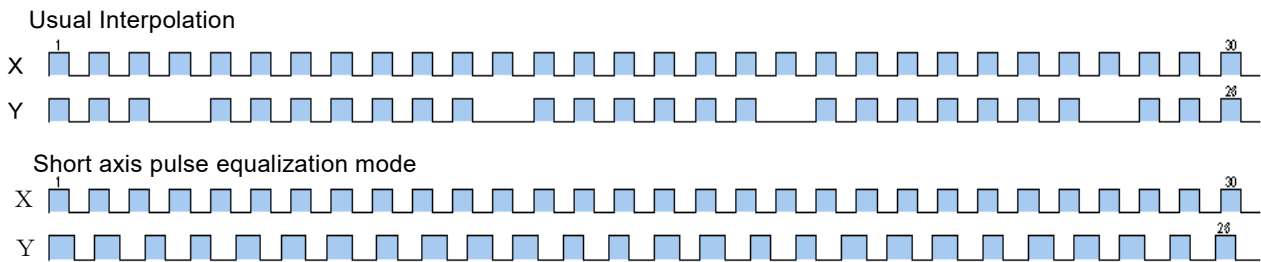

Fig. 1.1-5 Pulse Output in 2-axis Linear Interpolation with Moving Distance of X: 30 pulses and Y: 26 pulses

2-Axis High Accuracy Constant Vector Speed Mode

Vector speed is the driving speed of the tip of a locus performing interpolation driving, and it is also called Head speed. In operations such as machining or coating workpieces during interpolation driving, it is important to keep this vector speed constant. MCX514 realizes 2-axis high accuracy constant vector speed mode that increases the accuracy of constant vector speed considerably, in addition to the existing constant vector speed mode. In 2-axis linear interpolation, circular interpolation and helical interpolation driving, if the short axis pulse equalization mode described above and 2-axis high accuracy constant vector speed mode are used in combination, the speed deviation of vector speed can be within $\pm 0.2\%$ or less, and it will considerably improve the speed accuracy in interpolation driving.

The figure below is each graph of speed deviation of circular interpolation driving with radius 10,000 pulses, when performed in the existing constant vector speed mode and when performed in MCX514 2-axis high accuracy constant vector speed mode.

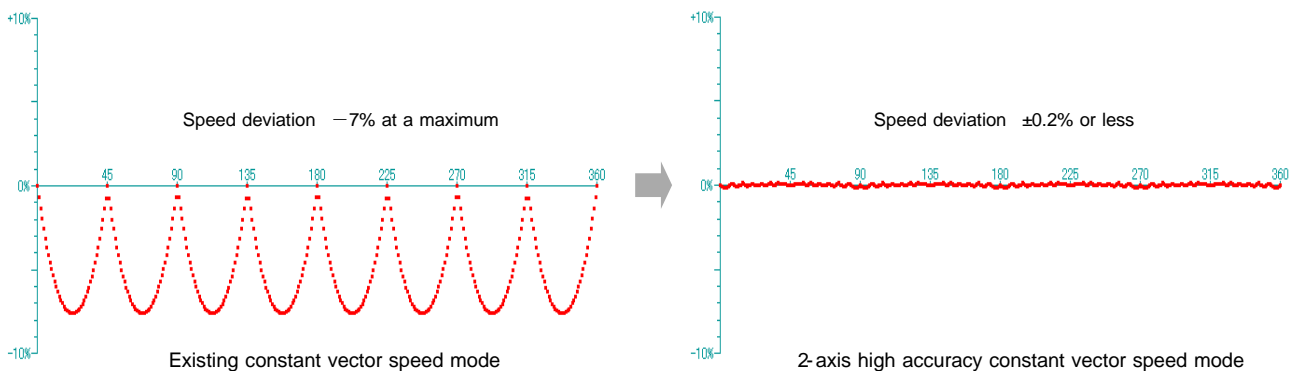

Fig. 1.1-6 Speed Deviation in Constant Vector Speed Mode

Speed Range-Free

MCX514 is a new motion control IC that has no multiple of speed (Range Setting) to set the drive speed. This will enable us to freely set the speed from 1 pps up to 8 Mpps in increments of 1 pps.

When using the multiples of speed to set the speed by existing method, there are restrictions as described below.

- For the detailed speed setting of low-speed, less multiples of speed must be set.
→ As a result, driving cannot be shifted to high-speed.
- To perform the high-speed driving, larger multiples of speed must be set.
→ As a result, the detailed setting of drive speed cannot be configured.

MCX514 brings solutions to the inconvenience described above by Speed range-free, which makes it possible to directly change the speed from low-speed such as 1 or 2 pps to high-speed such as 1 Mpps during the driving.

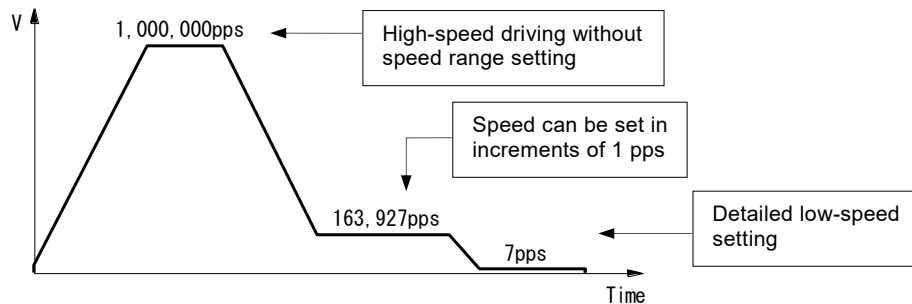

Fig. 1.1-7 Speed Range-Free

Easy and High-Accuracy Speed Setting

Since there is no need to set multiples of speed (Range Setting), the user can set a drive speed of output pulses as a speed parameter (at CLK = 16MHz).

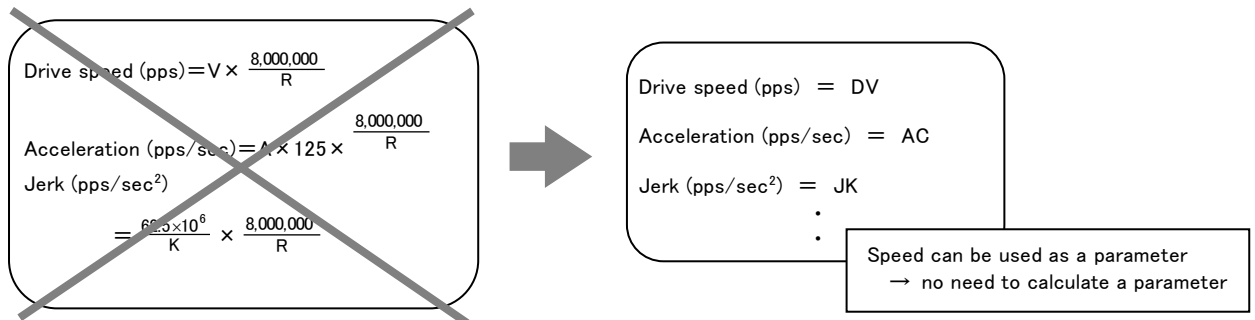

Fig. 1.1-8 Speed Parameter Setting

In the range of 1 pps to 8 Mpps, it can output the drive speed that is set with high accuracy. Speed accuracy of the pulse output is less than ± 0.1%, which is on the assumption that there is no frequency error of input clock (CLK). In fact, there is a frequency error of input clock (CLK), and speed accuracy depends on it.

■ Various Acceleration / Deceleration Drive Mode

◆ Types of acceleration / deceleration driving

Acceleration / deceleration driving can perform the following driving.

- Constant speed driving
- Linear acceleration / deceleration driving (symmetry/ non-symmetry)
- S-curve acceleration/deceleration driving (symmetry/ non-symmetry)

◆ Automatic deceleration start

In position driving of linear acceleration/deceleration (symmetry/non-symmetry) and S-curve acceleration/deceleration (symmetry), the IC calculates the deceleration start point when in deceleration, and automatically starts deceleration. (This is not applied to non-symmetry S-curve acceleration/deceleration driving.)

◆ S-curve acceleration/deceleration curve

S-curve acceleration/deceleration uses the method which increases / decreases acceleration or deceleration in a primary line, and the speed curve forms a secondary parabola acceleration/deceleration. In addition, it prevents triangle waveforms by a special method during S-curve acceleration/deceleration.

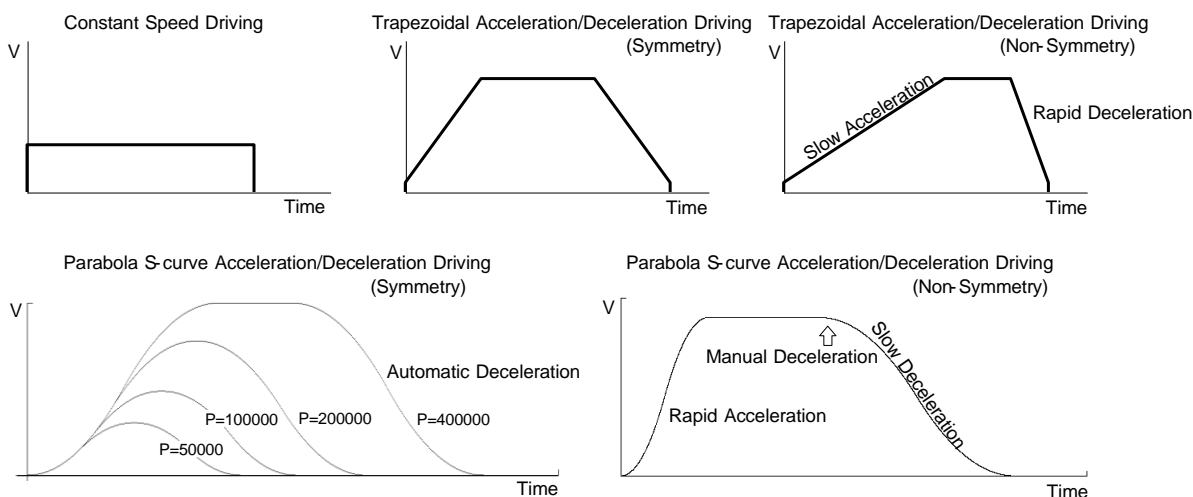

Fig. 1.1-9 Acceleration / Deceleration Drive Mode

■ Position Control

MCX514 has two 32-bit position counters: one is a logical position counter that counts the number of output pulses and the other is a real position counter that counts the feedback number of pulses from an external encoder.

The current position can be read by data reading commands anytime.

By using with synchronous action, the operation can be performed by the activation factor based on position data, such as drive speed change or start/stop of another axis driving at a specified position.

■ Software Limit

MCX514 has a software limit function that controls driving to stop when the position counter is over a specified range. There are 2 stop types for when the software limit function is enabled: decelerating stop and instant stop.

■ Various Synchronous Actions

Synchronous action is the function that executes a specified action together if a specified activation factor occurs. These synchronous actions can be performed fast and precisely, independent of the CPU.

Synchronous action can be set up to 4 sets to each axis.

1 set of synchronous actions is configured with one specified activation factor and one specified action. 15 types of activation factors are provided, such as the passage of a specified position, start/termination of driving, the rising/falling edge of an external signal and expiring of an internal timer. In addition, 28 types of actions are provided, such as start/termination of driving, save the current position counter value to multi-purpose register and writing of a drive speed.

When an activation factor of 1 set of any axis occurs, the other 3 sets of the same axis and 1 set of another axis, which are total 7sets of actions, can be activated simultaneously.

Multiple synchronous action sets can be used in combination, which allows users to develop a wide array of applications.

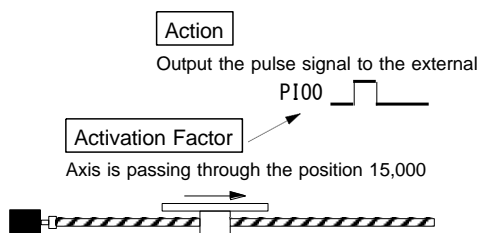

- Outputs an external signal when passing through a specified position during the driving.
- Saves the current position to a specified register when an external signal is input during the driving.
- Outputs N split pulses from a specified position to the external during the driving.

Fig. 1.1-10 Synchronous Action

■ Four Multi-Purpose Registers

MCX514 has four 32-bit length multi-purpose registers in each axis.

Multi-purpose register can be used to compare with the current position, speed and timer, and then can read out the status which represents comparison result and can output as a signal. In addition, it can activate a synchronous action according to comparison result or can generate an interrupt.

By using with synchronous action, it can save values of current position or speed of during the driving to multi-purpose registers and load values that are saved in multi-purpose registers to the output pulse number or drive speed.

■ Timer Function

MCX514 is equipped with a timer in each axis, which can set with the range of 1 ~ 2,147,483,647 μ sec in increments of 1 μ sec (at CLK = 16MHz). By using with synchronous action, the following operations can be performed precisely.

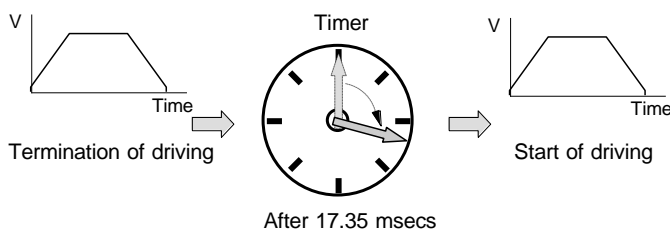

- Starts driving after specified periods when the driving is finished.
- Starts driving after specified periods after an external signal is input.
- Stops continuous pulse driving after specified periods.
- Times from position A to position B.

Fig. 1.1-11 Timer Function

Output of Split Pulse

This is a function in each axis that outputs split pulses during the driving, which synchronizes axis driving and performs various operations. The split length, pulse width of a split pulse and split pulse number can be set. By using with synchronous action, the output of split pulses can be started/terminated at a specified position and the split length or pulse width of a split pulse can be changed by an external signal. Split pulses can be output corresponding to an arbitrary axis during interpolation driving.

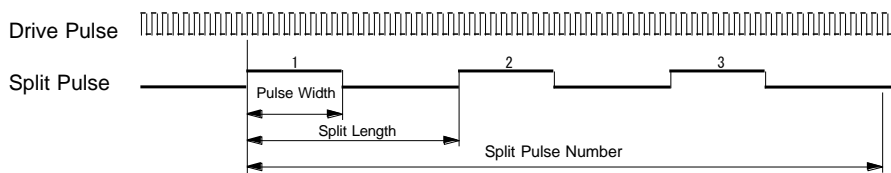

Fig. 1.1-12 Split Pulse Output

Automatic Home Search Function

This IC is equipped with the function that automatically executes a home search sequence without CPU intervention. The sequence comprises high-speed home search → low-speed home search → encoder Z-phase search → offset drive.

Deviation counter clear pulses can be output for a servo motor driver. In addition, the timer between steps which sets stop time among each step is available, and the operation for a home search of a rotation axis is provided.

Servo Motor Feedback Signals

MCX514 has input pins for servo feedback signals such as encoder 2-phase, in-positioning and alarm signals. An output signal for clearing a deviation counter is also available.

Interrupt Signals

MCX514 has 2 interrupt signals (INT0N, INT1N).

INT0N signal is used to generate an interrupt by various factors. For example, (1). at the start / finish of a constant speed drive during the acceleration/deceleration driving, (2). at the end of driving, and (3). when the comparison result of a multi-purpose register with a position counter changes.

INT1N signal is used to request to transfer next segment data to CPU while continuous interpolation driving is performed.

Driving by External Signals

Driving can be controlled by external signals, which are the relative position driving, continuous pulse driving and manual pulsar driving. This function is used for JOG feed or teaching mode, reducing the CPU load and making operations smooth.

■ Built-in Input Signal Filter

The IC is equipped with an integral type filter in the input step of each input signal. It is possible to set for each input signal whether the filter function is enabled or the signal is passed through. A filter time constant can be selected from 16 types (500nsec ~ 16msec).

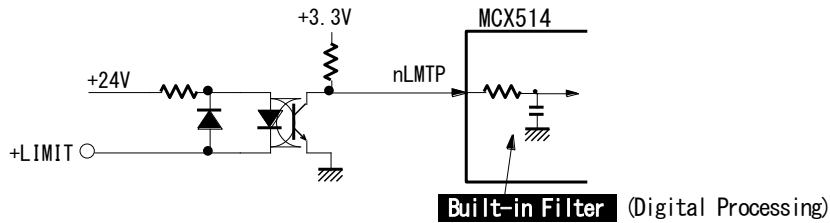

Fig. 1.1-13 Built-in Input Signal Filter

■ Real Time Monitoring

During the driving, the current status such as logical position, real position, drive speed, acceleration / deceleration, status of accelerating / constant speed driving / decelerating / acceleration increasing / acceleration constant / acceleration decreasing and a timer can be read in real time.

■ CPU Interface

This IC has I²C serial interface bus in addition to the existing 8-bit/16-bit data bus as the interface to connect a host CPU. I²C serial interface bus needs only 2 lines: serial data line (SDA) and serial clock line (SCL), so the user can use such a PIC™ microcomputer that has few terminals as a host CPU. I²C bus can be connected with several devices such as MCX514 or EEPROM that have I²C bus interface on the same bus.

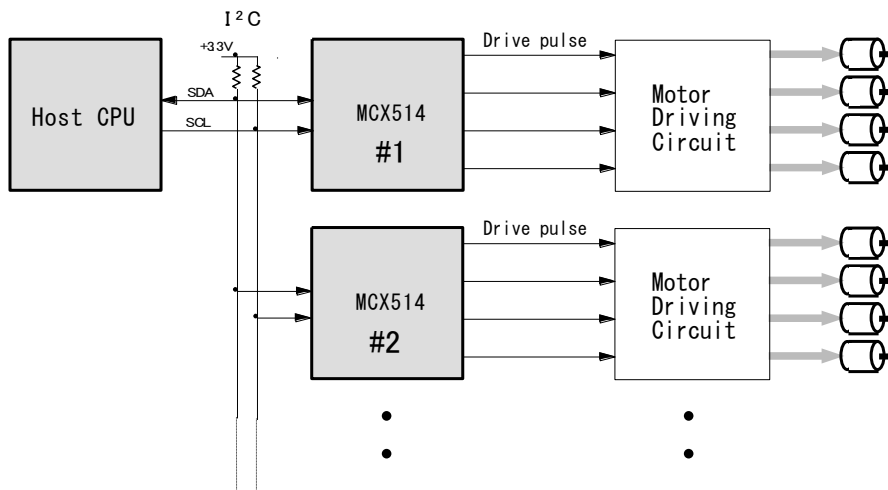

Fig. 1.1-14 I²C Serial Interface Bus

1.2 Functional Block Diagram

MCX514 functional block diagram is shown in the Fig. 1.2-1 as below. It comprises control sections of 4 axes, X, Y, Z and U that have the same function, and interpolation counting sections. In interpolation driving, interpolation is calculated at the timing of basic pulse oscillation of a specified main axis (AX1), which can be performed both in constant and acceleration/deceleration driving.

Fig. 1.2-2 is the functional block diagram of each axis control section.

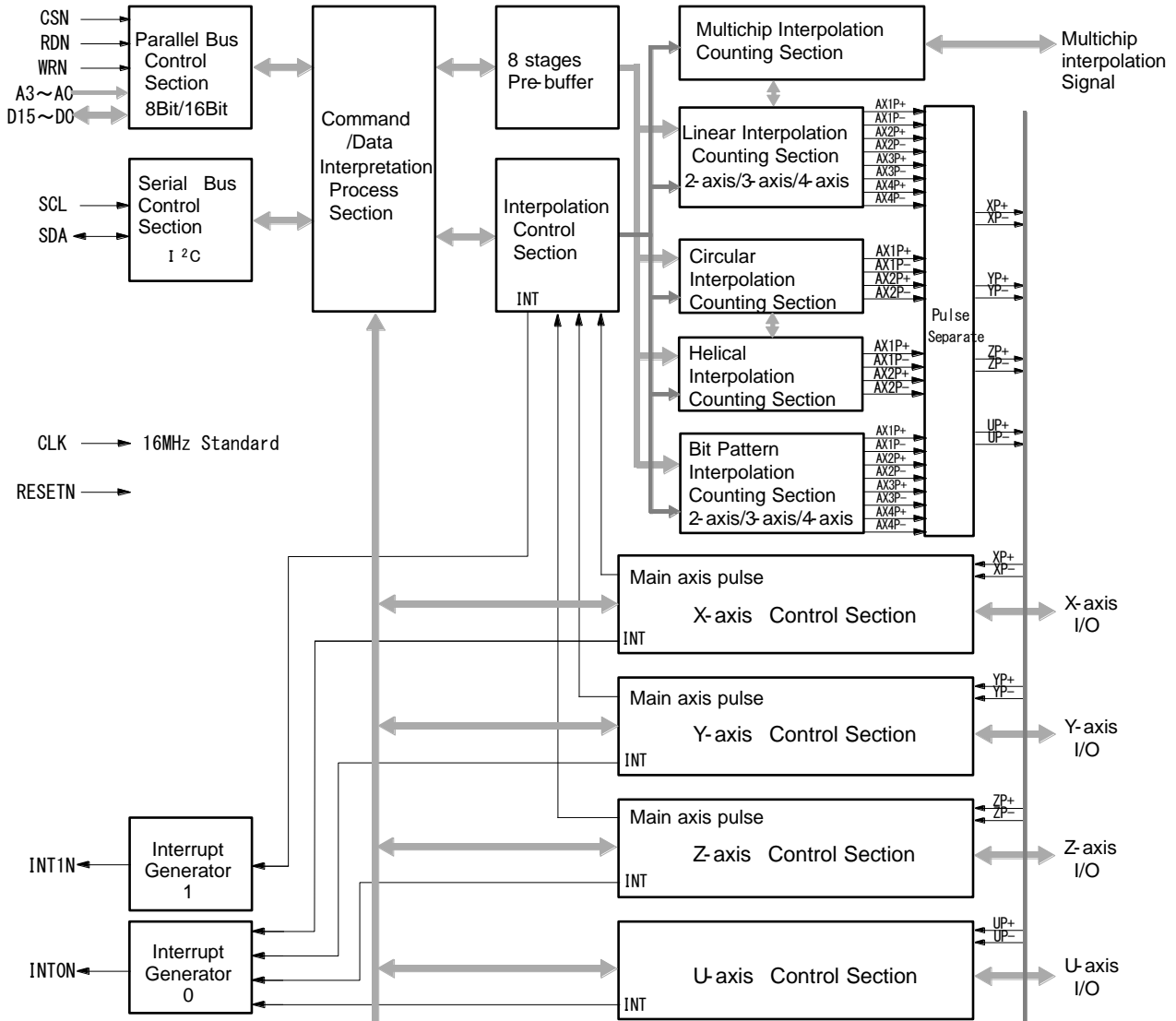
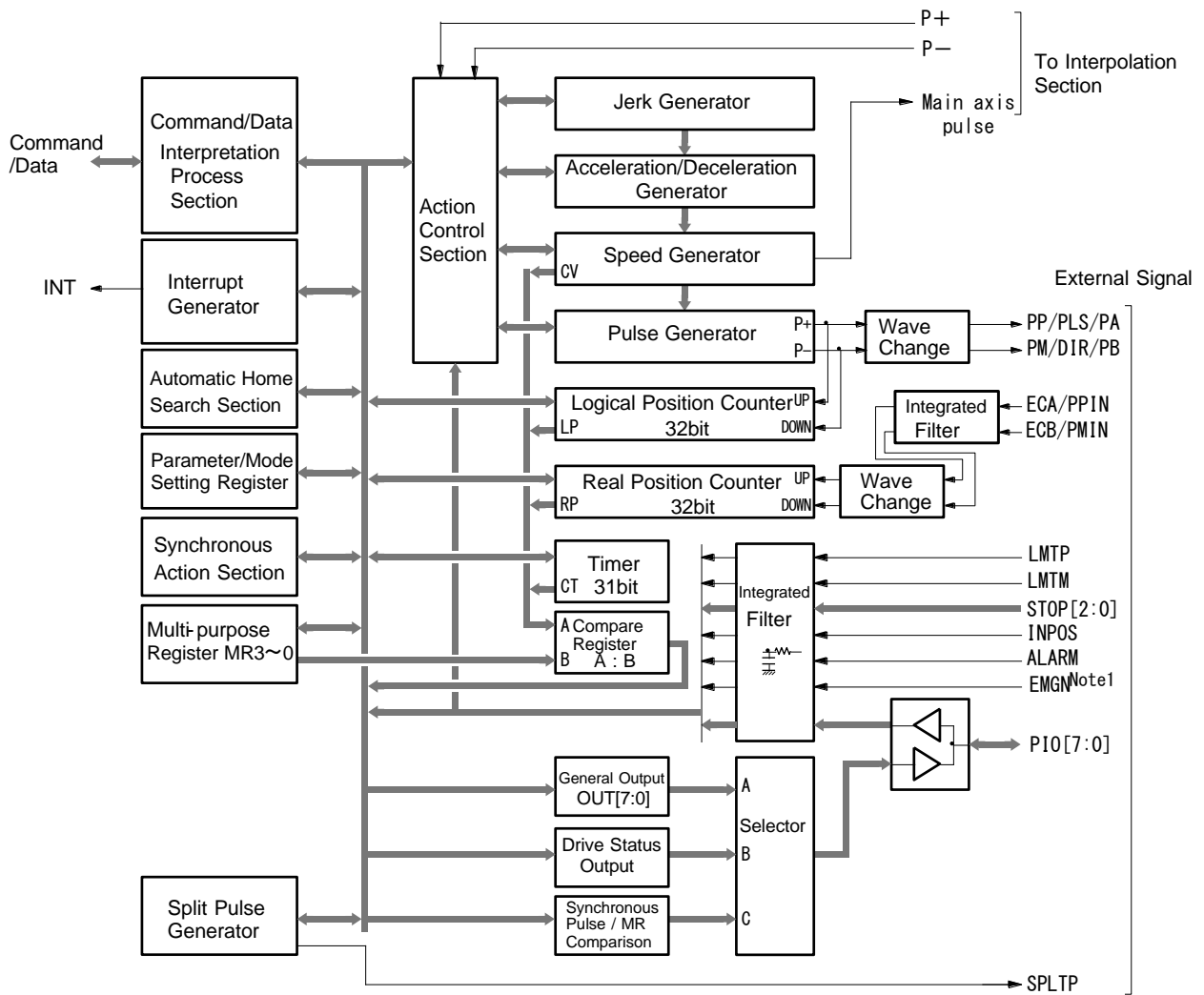

Fig. 1.2-1 MCX514 The Whole Functional Block Diagram



Note1: EMGN is in common all axes.

Fig. 1.2-2 Block Diagram of X, Y, Z and U-Axis Control Section (of 1 axis)

1.3 Specification Table

(CLK=16MHz)

Item	Subitem	Description	
Control Axis		4 axes	
CPU Parallel Bus Connection		16-bit/8-bit bus selectable	
CPU Serial Bus Connection		I ² C serial interface bus	
Interpolation Function	Interpolation Commands	2-axis /3-axis /4-axis linear interpolation, CW/CCW circular interpolation 2-axis /3-axis /4-axis bit pattern interpolation, CW/CCW helical interpolation	
	Interpolation Range	Each axis -2,147,483,646 ~ 2,147,483,646 drive pulse	
	Interpolation Speed	1 pps ~ 8,000,000 pps	*11
	Interpolation Accuracy	±0.5LSB or less (linear interpolation) ±1LSB or less (circular interpolation)	
	Other Interpolation Related Functions	<ul style="list-style-type: none"> • Can select any axis • Short axis pulse equalization • Constant vector speed (2-axis/3-axis simple mode, 2-axis high-accuracy mode selectable) • Continuous interpolation • Data buffering by 8 stages preregister • Single step interpolation • Multichip axes linear interpolation 	
Drive Pulses Output	Drive Speed Range	1 pps ~ 8,000,000 pps (When CLK=20MHz: up to 10,000,000 pps)	
	Initial Speed Range	1 pps ~ 8,000,000 pps	
	Pulse Output Accuracy	±0.1% or less (according to the setting speed)	
	Acceleration Range	1 pps/sec ~ 536,870,911pps/sec	
	Acceleration Increasing / Decreasing Rate Range	1 pps/sec ² ~ 1,073,741,823 pps/sec ²	*1
	Acceleration / Deceleration Curve	Constant speed, Symmetrical/non-symmetrical linear acceleration/deceleration, Symmetrical/non-symmetrical parabola S-curve acceleration / deceleration	
	Drive Pulse Range	<ul style="list-style-type: none"> • Relative position driving: -2,147,483,646~2,147,483,646 drive pulse • Absolute position driving: -2,147,483,646~2,147,483,646 drive pulse 	*2
	Position Driving Decelerating Stop Mode	Automatic deceleration stop / Manual deceleration stop	*3
	Override	Output pulse number and drive speed are changeable during the driving	*4
	Driving Commands	Relative / Absolute position driving, +/- direction continuous driving	
	Triangle Form Prevention	Can be used both in linear and S-curve acceleration / deceleration	
	Drive Pulse Output Type	Independent 2-pulse, 1-pulse 1-direction, Quadrature pulse and quad edge evaluation, Quadrature pulse and double edge evaluation are selectable	
	Drive Pulse Output Logic	Positive / Negative logical level selectable	
Drive Pulse Output Pin	Possible to pin inversion		
Encoder Input	Input Pulse Input Type	Quadrature pulses input and quad edge evaluation, Quadrature pulses input and double edge evaluation, Quadrature pulses input and single edge evaluation, Up / down pulse input are selectable	
	Input Pin	Possible to pin inversion	

Position Counter	Logical Position Counter	Count Range : -2,147,483,648 ~ +2,147,483,647 drive pulse	*5
	Real Position Counter	Count Range : -2,147,483,648 ~ +2,147,483,647 drive pulse	*5
	Variable Ring	Possible to set the count maximum value of each counter	
Software Limit	Setting Range	-2,147,483,647 ~ +2,147,483,647 pulse	
	Stop Mode	Decelerating / Instant stop selectable	
Multi-Purpose Register	Bit Length, Number of Registers	32-bit length 4 registers per axis	
	Uses	Compare with position, speed and timer value, load data such as position and speed, and save data such as current position, speed and timer value	
Timer	Number of timers	1 per axis	
	Setting Range	1 ~ 2,147,483,647μsec	
Split Pulse	Number of signals	1 per axis	
	Split Length	2 ~ 65,535 drive pulse	*6
	Split Pulse Width	1 ~ 65,534 drive pulse	
	Split Pulse Number	1 ~ 65,535, or up to infinity	
Automatic Home Search	Sequence	STEP1 high-speed home search → STEP2 low-speed home search → STEP3 encoder Z-phase search → STEP4 offset drive • Enable / Disable each step and search signal / direction are selectable	
	Deviation Counter Clear Output	Clear pulse width within the range of 10μ~20msec, Logical level selectable	
	Timer between Steps	1msec ~ 1,000msec selectable	
Synchronous Action	Number of Sets	4 sets per axis	*7
	Activation Factor	<ul style="list-style-type: none"> • When multi-purpose register comparison changed <ul style="list-style-type: none"> • Comparative object: logical/real position counter value, current drive speed, current timer value • Comparison condition: \geq, $>$, $=$, $<$ • When a timer is up • Start/Termination of driving, Start/Termination of driving at constant speed area in acceleration / deceleration driving • Start/Termination of split pulse, Output of split pulse • nPIOm signal \uparrow/\downarrow, nPIOm+4 signal Low and nPIOm signal \uparrow, nPIOm+4 signal Hi and nPIOm signal \uparrow, nPIOm+4 signal Low and nPIOm signal \downarrow, nPIOm+4 signal Hi and nPIOm signal \downarrow (m:0,1,2,3) • Activation command 	
	Action	<ul style="list-style-type: none"> • Load value (MRm→setting value): Drive speed, Drive pulse number (Finish point), Split length, Split pulse width, Logical/Real position counter value, Initial speed, Acceleration • Save value (MRm←current value): Logical/Real position counter value, Current timer value, Current drive speed, Current acceleration / deceleration • Synchronous pulse output to the external • Start of relative/absolute position driving, Start of +/– direction continuous driving, Start of relative/absolute position driving at the position set by MRm • Decelerating stop / Instant stop, Speed increase/decrease, Timer- start/stop, Start / Termination of split pulse 	
	Other SYNC Activation	Activation of other 3 sets actions can be set.	
	Other Axes SYNC0 Activation	Activation of another SYNC0 action can be set.	
Repeat	Synchronous action can be operated once/repeatedly.		

Interrupt	Number of Signals	2: INT0N, INT1N	
	Interrupt Factor	<ul style="list-style-type: none"> •When multi-purpose register comparison changed <ul style="list-style-type: none"> •Comparative object: logical/real position counter value, current drive speed, current timer value •Comparison condition: \geq, $>$, $=$, $<$ •Start/Termination of driving, Start/Termination of acceleration/deceleration driving at constant speed •When automatic home search is finished, When a timer is up •Output/Termination of split pulse, •When synchronous action 0 / 1 / 2 / 3 is activated •When the state of 8 stages of pre-buffer register changes (in continuous interpolation driving). 	
	Enable / Disable	Enable / Disable each interrupt factor is selectable	
External Signal for Driving		<ul style="list-style-type: none"> •Relative position/Continuous driving by EXPP, EXPM signals •Manual pulsar (encoder input: quadrature pulses input and single edge evaluation) •Single step interpolation by EXPLSN signal 	*8
External Stop Signal	Number of Signals	3 signals (STOP0~2) per axis	
	Enable / Disable	Enable / Disable stop signal function is selectable	*9
	Logical Level	Low / Hi active is selectable	
	Stop Mode	When it is active, decelerating stop (When driving under initial speed, instant stop)	
Servo Motor Input/Output Signal	Signals	Each axis: ALARM (alarm), INPOS (in-position), DCC (deviation counter clear)	
	Enable / Disable	Enable / Disable a signal is selectable.	
	Logical Level	Low / Hi active is selectable.	
General Input/Output Signal	Number of Signals	8 signals per axis <ul style="list-style-type: none"> •Synchronous input, pins share the input pin for driving by external signals. •Synchronous action output, multi-purpose register comparison output, pins share drive status output signal pins. 	
Driving Status Output Signal	Signals	<ul style="list-style-type: none"> •Driving, Error, Accelerating, Constant speed driving, Decelerating, Acceleration increasing, Acceleration constant, Acceleration decreasing •Drive status can also be read by status register. 	*10
Over Limit Signal	Number of Signals	2 signals per axis (for each + and - direction)	
	Enable / Disable	Enable / Disable limit function is selectable.	*9
	Logical Level	Low / Hi active is selectable.	
	Stop Mode	Decelerating stop or instant stop is selectable when it is active.	
	Input Pin	Possible to pin inversion	
Emergency Stop Signal		EMGN 1 signal in all axes, stops drive pulse output at Low level. (Logical level cannot be set)	
Integral Type Filter	Input Signal Filter	Equipped with integral filters in the input column of each input signal.	
	Time Constant	Time constant can be selected from 16 types. (500n, 1 μ , 2 μ , 4 μ , 8 μ , 16 μ , 32 μ , 64 μ , 128 μ , 256 μ , 512 μ , 1m, 2 m, 4 m, 8 m, 16 m[sec])	
	Enable / Disable	Enable / Disable filter function is selectable.	
Electrical Characteristics	Operating Temperature	-40°C~+85°C	
	Operating Power Voltage	+3.3V \pm 10%	
	Consumption Current	150mA (average), 204mA(max) at CLK=16MHz	
	Input Clock Pulse	16MHz (standard) 20MHz (max)	
	Output Signal Level	3.3V CMOS Level (only TTL can be connected to 5V type)	
Package		<ul style="list-style-type: none"> •144-pin plastic QFP, pin pitch: 0.5mm, RoHS compliant •Dimension: 20×20×1.4 mm 	

<Further Note>

*1	Parameter that is used in S-curve acceleration / deceleration driving.
*2	Pulse range that can be set for the driving and it outputs specified pulses. In continuous driving, pulses are output up to infinity.
*3	Automatic deceleration stop performs decelerating stop automatically by calculating the deceleration start point based on specified drive pulses. Manual deceleration stop performs decelerating stop by setting the deceleration start point from the high order. This IC can perform automatic deceleration stop except for non-symmetrical S-curve acceleration / deceleration.
*4	After the start of driving, output pulse number can be changed for the same direction in only relative position driving. The drive speed cannot be changed during continuous interpolation driving.
*5	Logical position counter counts output pulses and real position counter counts encoder input pulses.
*6	While driving, split pulses are output at specified intervals in synchronization with driving pulses.
*7	1 set of synchronous actions is configured with one specified activation factor and one specified action.
*8	Input pins for external signals share the general purpose input / output pins.
*9	When the function is not used, it can be used as general purpose input.
*10	Drive status output signal pins share the general purpose input / output pins.
*11	Bit pattern interpolation is 4Mpps or less, helical interpolation is 250Kpps or less, continuous interpolation is 4Mpps and multichip interpolation is 4Mpps or less.

2. The Descriptions of Functions

2.1 Fixed Pulse Driving and Continuous Pulse Driving

There are two kinds of pulse output commands: fixed pulse driving that is performed based on the number of output pulses predetermined and continuous pulse driving that outputs pulses until a stop command is written or stop signal is input. Fixed pulse driving has relative position driving, absolute position driving and counter relative position driving. Continuous pulse driving has + direction continuous pulse driving and - direction continuous pulse driving.

- Fixed pulse driving
 - Relative position driving
 - Absolute position driving
 - Counter relative position driving
- Continuous pulse driving
 - +Direction continuous pulse driving
 - -Direction continuous pulse driving

2.1.1 Relative Position Driving

Relative position driving performs the driving by setting the drive pulse number from the current position. To drive from the current position to the + direction, set the positive pulse number as the drive pulse number, and to the - direction, set the negative pulse number as the drive pulse number.

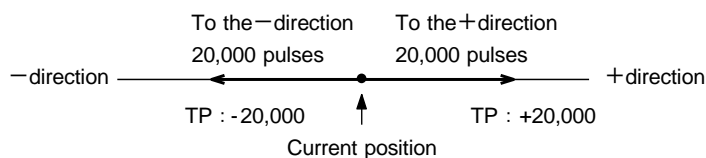

Fig. 2.1-1 Setting Example of Drive Pulse Number (TP) in Relative Position Driving

Relative position driving performs constant speed driving or acceleration / deceleration driving. Relative position driving in the acceleration / deceleration where acceleration and deceleration are equal, as shown in Fig. 2.1-2, automatic deceleration starts when the number of pulses becomes less than the number of pulses that were utilized at acceleration, and driving terminates when the output of specified drive pulses is completed.

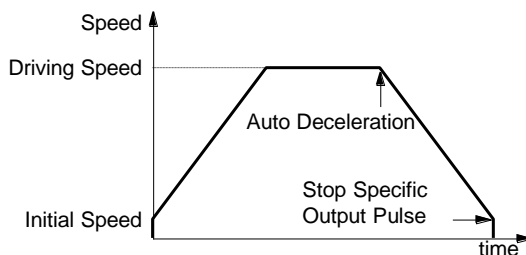

Fig. 2.1-2 Auto Deceleration and Stop in Relative Position Driving

Command code for relative position driving is 50h. To perform relative position driving in linear acceleration / deceleration, the following parameters must be set.

Table 2.1-1 Setting Parameters : Relative Position Driving

Parameter	Symbol	Comment
Acceleration / Deceleration	AC/DC	No need to set deceleration when acceleration and deceleration are equal.
Initial speed	SV	
Drive speed	DV	
Drive pulse number / Finish point	TP	Set +pulse number for the + direction. Set -pulse number for the - direction.

2.1.2 Absolute Position Driving

Absolute position driving performs the driving by setting the destination point based on a home (logical position counter = 0). The destination point can be set by absolute coordinates regardless of the current position. The IC calculates drive direction and output pulse number according to the difference between the specified destination point and current position, and then performs the driving. In absolute position driving, the destination point should be set by absolute coordinates within the range of driving space. So, the user first needs to perform automatic home search to determine the logical position counter before driving.

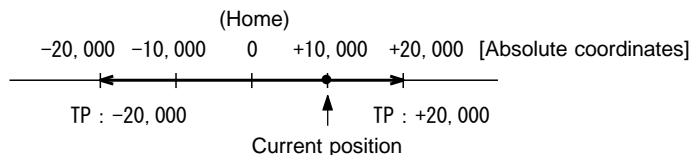

Fig. 2.1-3 Example of Specifying Finish Point (TP) in Absolute Position Driving

Absolute position driving performs constant speed driving or acceleration / deceleration driving as well as relative position driving. Command code for absolute position driving is 54h. To perform absolute position driving in linear acceleration / deceleration, the following parameters must be set.

Table 2.1-2 Setting Parameters : Absolute Position Driving

Parameter	Symbol	Comment
Acceleration / Deceleration	AC/DC	No need to set deceleration when acceleration and deceleration are equal
Initial speed	SV	
Drive speed	DV	
Drive pulse number / Finish point	TP	Set the destination point by absolute coordinates.

2.1.3 Counter Relative Position Driving

Counter relative position driving performs the driving by setting the direction and drive pulse number to the destination point based on the current position. Unlike relative position driving, driving is performed in a direction opposite to the sign of the pulse number that is set as drive pulse number (TP). This is useful for when the user wants to determine a drive direction using a driving command, by setting the predetermined positive value to the drive pulse number in advance. If the negative value is set as the drive pulse number, counter relative position driving performs the driving in the + direction.

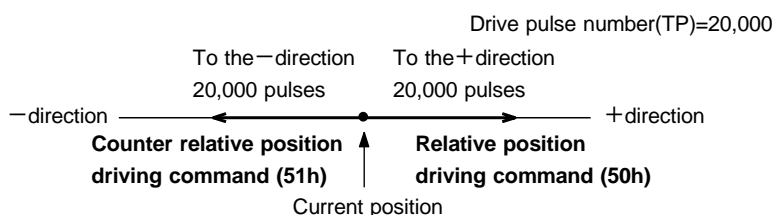

Fig. 2.1-4 Driving Direction is Determined by Relative/Counter Relative Position Driving Command

The operation of counter relative position driving is the same as relative position driving except the operation which drives in a direction opposite to the sign of the pulse number that is set as drive pulse number (TP). Command code for counter relative position driving is 51h.

Changing Drive Pulse Number in the middle of Driving (Override)

The drive pulse number (TP) can be changed in relative position driving and counter relative position driving. However, the drive direction must be the same before and after the change of drive pulse number. The drive pulse number cannot be changed to the value of different direction.

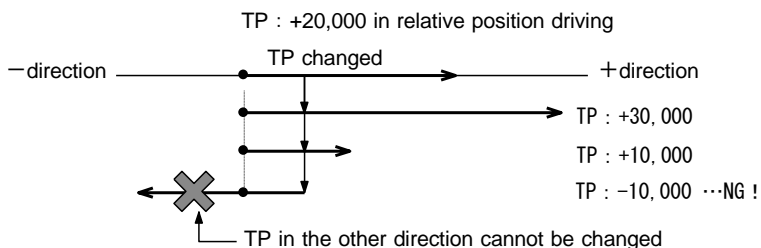

Fig. 2.1-5 Override Drive Pulse Number (TP) in Relative Position Driving

In acceleration / deceleration driving, if the rest of output pulses become less than the pulses at acceleration, and the drive pulse number (TP) is changed during deceleration, the driving accelerates again (Fig. 2.1-7). And if the output pulse number of changed drive pulse number (TP) is less than the number of pulses already output, the driving stops immediately (Fig. 2.1-8). In S-curve acceleration / deceleration driving, if the drive pulse number (TP) is changed during deceleration, the S-curve profile cannot be exactly tracked.

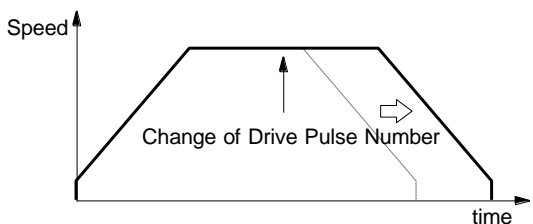

Fig. 2.1-6 Change of Drive Pulse Number in Driving

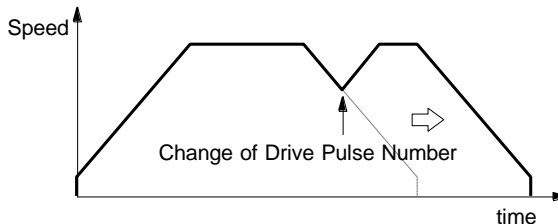

Fig. 2.1-7 Change of Drive Pulse Number in Deceleration

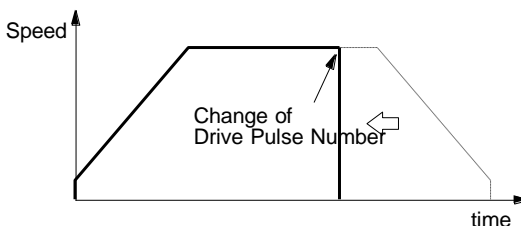

Fig. 2.1-8 Changing Drive Pulse Number Less than Output Pulse Number

[Note]

The drive pulse number (TP) cannot be changed while Absolute position driving.

Manual Deceleration for Fixed Pulse Acceleration / Deceleration Driving

As shown in Fig. 2.1-2, generally the deceleration of fixed pulse driving (relative position driving, absolute position driving and counter relative position driving) is controlled automatically by MCX514. However, in the following situations, it should be preset the deceleration point by the users.

- The change of speed is too often in the trapezoidal acceleration/deceleration fixed pulse driving.

- Speed is changed during the driving in the non-symmetry trapezoidal acceleration/deceleration and S-curve acceleration/deceleration fixed pulse driving.
- Acceleration, deceleration, jerk (acceleration increasing rate) and deceleration increasing rate are set individually for S-curve acceleration/deceleration fixed pulse driving (non-symmetry S-curve acceleration/deceleration).
- Circular interpolation, bit pattern interpolation and continuous interpolation are performed in acceleration/deceleration.

To perform manual deceleration mode, please set D0 bit of WR3 register as 1, and use manual decelerating point setting command (07h) to set a deceleration point. As to other operations, the setting is the same as those of fixed pulse driving.

■ Offset Setting for Acceleration/Deceleration Driving

The offset function can be used for compensating the pulses when the decelerating speed does not reach the setting initial speed during acceleration/deceleration fixed pulse driving. MCX514 will calculate the acceleration / deceleration point automatically, and arrange the output pulses of deceleration phase that is equal to those of acceleration phase.

When setting the offset for deceleration, MCX514 will start deceleration early for the offset. The greater positive value is set for the offset, the closer the automatic declaration point becomes, for this reason creep pulses of the initial speed will increase at the termination of deceleration. If a negative value is set for the offset, output may stop prematurely before the speed reaches the initial speed (see Fig. 2.1-9).

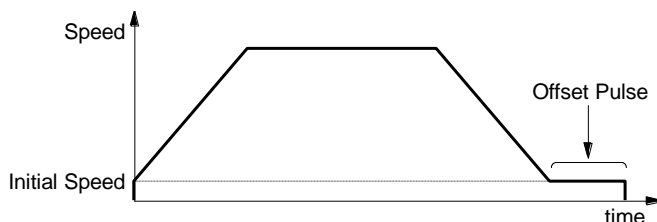

Fig. 2.1-9 Offset for Deceleration

The default value for the offset is 0 when MCX514 power-on reset. It is not necessary to change the shift pulse value in normal acceleration/deceleration fixed pulse driving. As for fixed pulse driving in non-symmetrical trapezoidal acceleration/deceleration or S-curve acceleration/deceleration, if creep pulses or premature termination occurs at the termination of driving due to the low initial speed, correct by setting the acceleration counter offset appropriately.

2.1.4 Continuous Pulse Driving

When continuous pulse driving is performed, MCX514 will drive pulse output in a specific speed until a stop command or external stop signal becomes active. The user can use it for: home searching, teaching and speed control.

There are two stop commands, one is “decelerating stop” and the other is “instant stop”. And three input pins nSTOP0~nSTOP2 can be connected for external decelerating stop (instant stop when driving under initial speed) signal. Enable / disable and active level can be set by mode setting.

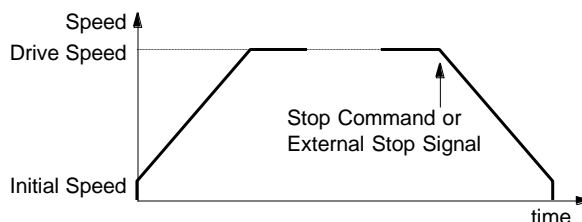

Fig. 2.1-10 Continuous Pulse Driving

+ Direction continuous pulse driving command (52h) and – Direction continuous pulse driving command (53h) are available. To perform acceleration/deceleration continuous pulse driving, parameters except drive pulse number (TP) must be set as well as fixed pulse driving.

Table 2.1-3 Setting Parameters : Continuous Pulse Driving

Parameter	Symbol	Comment
Acceleration / Deceleration	AC/DC	No need to set deceleration when acceleration and deceleration are equal.
Initial speed	SV	
Drive speed	DV	

■ Changing Drive Speed during the Driving (Override)

The drive speed can be changed freely during continuous pulse driving, which can be altered by changing a drive speed parameter (DV) or issuing a speed increase/decrease command.

In S-curve acceleration / deceleration driving, it will be invalid if the speed is changed in the middle of acceleration / deceleration.

In fixed pulse driving under the symmetry trapezoidal acceleration/deceleration and constant speed, a drive speed (DV) can be changed during the driving. However, if a speed of fixed pulse driving is changed at linear acceleration / deceleration, some premature termination may occur. So please note when using the IC with low initial speed.

In fixed pulse driving (automatic deceleration mode) under the non-symmetry trapezoidal acceleration/deceleration and S-curve acceleration / deceleration, the drive speed cannot be changed during the driving.

<Speed Change by Drive Speed Setting >

If a drive speed parameter (DV) is changed by drive speed setting command (05h), the setting will be immediately applied.

And if during acceleration / deceleration driving, the drive speed increases / decreases to a specified drive speed.

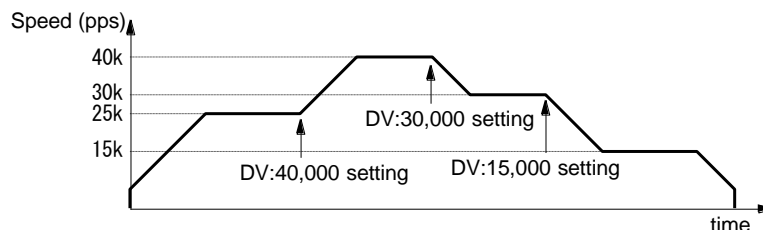

Fig. 2.1-11 Example of Drive Speed Change during the Driving

<Speed Change by Speed Increase / Decrease Command >

The speed increasing /decreasing value (IV) must be set in advance. If speed increase command (70h) or speed decrease command (71h) is written during the driving, the setting will be immediately applied. And if during acceleration / deceleration driving, the drive speed increases / decreases from the current drive speed to the value of the speed increasing / decreasing value setting.

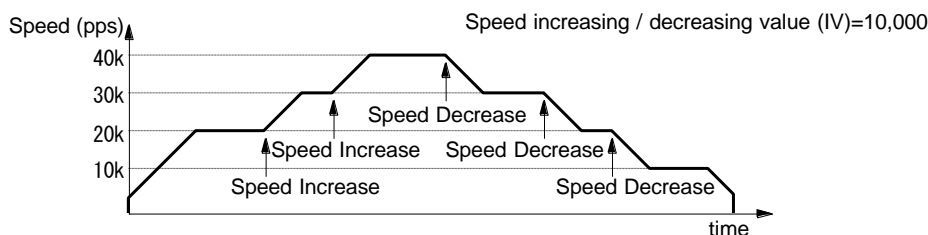

Fig. 2.1-12 Example of Speed Change by Speed Increase / Decrease Command

[Note]

- When changing a drive speed during fixed pulse driving, set the triangle form prevention function as disable (WR3/D13 : 1).

■ Stop Condition for External Input nSTOP2 to nSTOP0 in Continuous Pulse Driving

Assign a near home signal, a home signal and an encoder Z-phase signal in nSTOP0 to nSTOP2. (Assign an encoder Z phase signal in nSTOP2.) Enable / disable and logical levels can be set by WR2 register. If high-speed searching, continuous pulse driving is

performed at acceleration / deceleration. And when the signal that is enabled becomes active, MCX514 will perform decelerating stop. If low-speed searching, continuous pulse driving is performed at constant speed. And when the signal that is enabled becomes active, MCX514 will perform instant stop.

This IC has automatic home search function. See chapter 2.5 for details of automatic home search function.

2.2 Acceleration and Deceleration

There are the following speed curves that can trace from drive pulse output: Constant speed driving which does not perform acceleration / deceleration, Trapezoidal acceleration / deceleration driving which performs linear acceleration / deceleration to a setting speed, and S-curve acceleration / deceleration driving which performs acceleration / deceleration to a specified drive speed with a smooth curve.

And the following acceleration / deceleration driving is each available: Symmetry acceleration / deceleration where acceleration and deceleration are equal and Non-symmetry acceleration / deceleration where acceleration and deceleration are set individually.

- Constant speed driving
- Acceleration / Deceleration driving
 - Trapezoidal acceleration / deceleration driving
 - linear acceleration / deceleration (Symmetry)
 - Non-symmetry linear acceleration / deceleration
 - S-curve acceleration / deceleration driving
 - S-curve acceleration / deceleration (Symmetry)
 - Non-symmetry S-curve acceleration / deceleration

2.2.1 Constant Speed Driving

Constant speed driving outputs drive pulses at a constant speed without acceleration / deceleration. To perform constant speed driving, the drive speed must be set lower than the initial speed (that is the initial speed is higher than the drive speed.). Constant speed driving performs the driving at the drive speed lower than the initial speed without acceleration / deceleration. Stop mode is instant stop.

If the user wants to stop immediately when the home sensor or encoder Z-phase signal is active, perform the low-speed constant speed driving from the beginning not acceleration / deceleration driving.

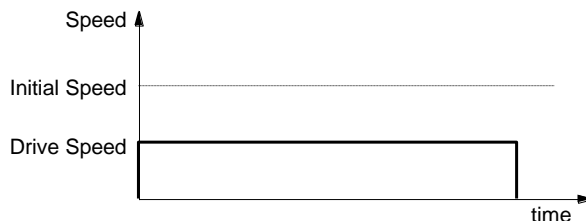

Fig. 2.2-1 Constant Speed Driving

To perform constant speed driving, the following parameters must be set.

Table 2.2-1 Setting Parameters : Constant Speed Driving

Parameter	Symbol	Comment
Initial speed	SV	Set higher than the drive speed (DV).
Drive speed	DV	
Drive pulse number / Finish point	TP	Not required for continuous pulse driving.

■ Example for Parameter Setting of Constant Speed

The constant speed is set at 980 PPS as shown in Fig. 2.2-2 below. In this case, the relative position driving that the drive pulse number is 2450 is performed.

Initial speed SV = 980 Set the value which initial speed \geq Drive speed
 Drive speed DV = 980
 Drive pulse number TP = 2450

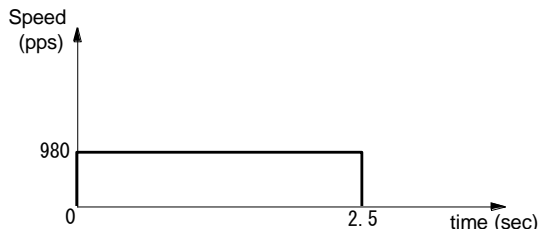

Please refer each parameter in chapter 7.2.

Fig. 2.2-2 Example of Constant Speed Driving

2.2.2 Trapezoidal Driving [Symmetrical]

In linear acceleration / deceleration driving, the driving accelerates from the initial speed at the start of driving to the drive speed in a primary linear form with a specified acceleration slope. Linear acceleration / deceleration driving can decelerate automatically and no need to set a decelerating point. In fixed pulse driving under the symmetry trapezoidal acceleration / deceleration where acceleration and deceleration are equal, it counts the number of pulses that were utilized at acceleration and automatic deceleration starts when the rest of output pulses become less than the pulses at acceleration. Deceleration continues in the primary line with the same slope as that of acceleration until the speed reaches the initial speed, and then driving will stop at the completion of the output all pulses.

If the decelerating stop command is performed during acceleration, the driving will start to decelerate during acceleration, as show in Fig. 2.2-3.

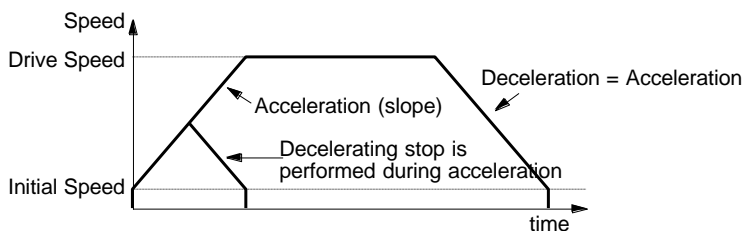

Fig. 2.2-3 Trapezoidal Driving (Symmetry)

To perform symmetry linear acceleration / deceleration driving using automatic deceleration, bits D2 to 0 of WR3 register and the following parameters must be set.

Table 2.2-2 Mode Setting : Linear Acceleration / Deceleration (Symmetry)

Mode Setting Bit	Symbol	Setting	Comment
WR3/D0	MANLD	0	Automatic deceleration
WR3/D1	DSNDE	0	When in deceleration, acceleration setting value is used (symmetry).
WR3/D2	SACC	0	Linear acceleration / deceleration

Table 2.2-3 Setting Parameters : Linear Acceleration / Deceleration (Symmetry)

Parameter	Symbol	Comment
Acceleration	AC	When in deceleration, this value is used to decelerate.
Initial speed	SV	
Drive speed	DV	
Drive pulse number / Finish point	TP	Not required for continuous pulse driving.

■ Example for Parameter Setting of Trapezoidal Driving

As shown in the figure right hand side, acceleration is formed from the initial speed 500 PPS to 15,000 PPS in 0.3 sec.

Acceleration AC = 48333 (15000-500)/0.3
 = 48333pps/sec
 Initial speed SV = 500
 Drive speed DV = 15000

Please refer each parameter in chapter 7.2.

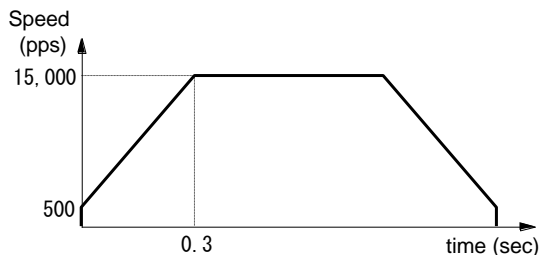

Fig. 2.2-4 Example of Trapezoidal Driving (Symmetry)

■ Triangle Form Prevention of Trapezoidal Driving (Fixed Pulse Driving)

The triangle form prevention function prevents a triangle form in linear acceleration/ deceleration fixed pulse driving even if the number of output pulses does not reach the number of pulses required for accelerating to a drive speed. The triangle form indicates the speed curve that shifts to deceleration during the acceleration phase in linear acceleration/ deceleration driving. When the number of pulses that were utilized at acceleration and deceleration exceeds 1/2 of the total number of output pulses during acceleration, this IC stops acceleration and keeps that driving speed and then decelerates automatically. Therefore, even if the number of output pulses is less in fixed pulse driving, 1/2 of the number of output pulses becomes constant speed area and can make the triangle form into the trapezoidal form.

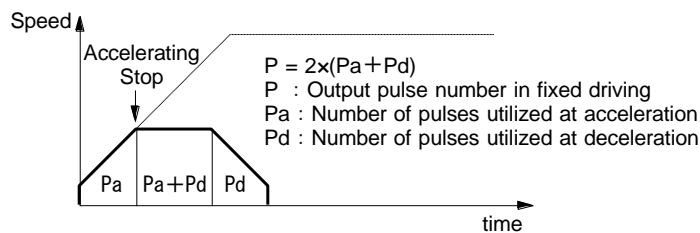

Fig. 2.2-5 Triangle Prevention of Linear Acceleration Driving

The triangle form prevention function in linear acceleration/ deceleration fixed pulse driving is enabled from a reset. And it can be disabled by setting D13 bit of WR3 register to 1.

If the decelerating stop command is performed during acceleration, the triangle form prevention does not work. As shown in Fig. 2.2-3, deceleration starts from when the decelerating stop is performed.

[Note]

- When changing a drive speed during the driving, set the triangle form prevention function as disable (WR3/D13 : 1).

2.2.3 Non-Symmetrical Trapezoidal Acceleration

If an object is to be moved using stacking equipment, there will be a need to change acceleration and deceleration of vertical transfer since gravity acceleration is applied to the object.

This IC can perform automatic deceleration in non-symmetrical linear acceleration / deceleration fixed pulse driving where acceleration and deceleration are different. It is not necessary to set a manual deceleration point by calculation in advance. Fig. 2.2-6 shows the case where the deceleration is greater than the acceleration and Fig. 2.2-7 shows the case where the acceleration is greater than the deceleration. In such non-symmetrical linear acceleration, the automatic deceleration start point is calculated by the IC based on the number of output pulses in fixed pulse driving and each rate parameter.

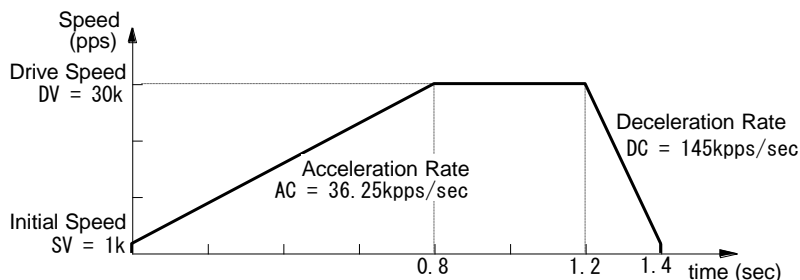

Fig. 2.2-6 Non-Symmetrical Linear Acceleration Driving (acceleration < deceleration)

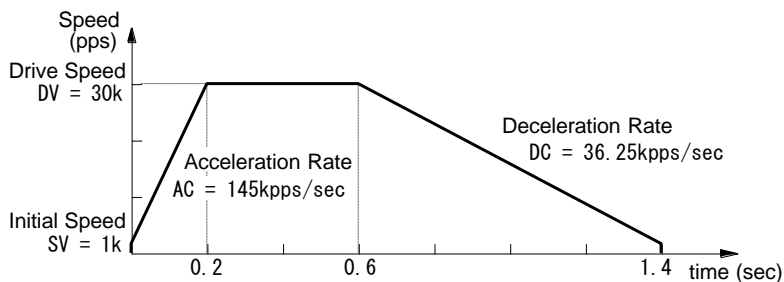

Fig. 2.2-7 Non-Symmetrical Linear Acceleration Driving (acceleration > deceleration)

To perform non-symmetry linear acceleration / deceleration driving using automatic deceleration, bits D2 to 0 of WR3 register and the following parameters must be set.

Table 2.2-4 Mode Setting : Non-symmetry Linear Acceleration / Deceleration

Mode Setting Bit	Symbol	Setting	Comment
WR3/D0	MANLD	0	Automatic deceleration
WR3/D1	DSNDE	1	When in deceleration, deceleration setting value is used.
WR3/D2	SACC	0	Linear acceleration / deceleration

Table 2.2-5 Setting Parameters : Non-symmetry Linear Acceleration / Deceleration

Parameter	Symbol	Comment
Acceleration	AC	
Deceleration	DC	
Initial speed	SV	
Drive speed	DV	
Drive pulse number / Finish point	TP	Not required for continuous pulse driving.

[Note]

- In non-symmetry linear automatic acceleration / deceleration driving, when acceleration > deceleration (Fig. 2.2-7), the following condition is applied to the ratio of acceleration and deceleration. In this case, set drive speed at 4Mpps or less.

$$DC > AC \times \frac{DV}{8 \times 10^6}$$

DC : Deceleration (pps/sec)
 AC : Acceleration (pps/sec) Where CLK = 16MHz

For instance, if the driving speed DV = 100kpps, deceleration DC must be greater than 1/80 of acceleration AC. The value must not be less than 1/80 of acceleration.

- In non-symmetry linear automatic acceleration / deceleration driving, if acceleration > deceleration (Fig. 2.2-7), the greater the ratio of acceleration AC to deceleration DC becomes, the greater the number of creep pulses becomes (about maximum of 10 pulses when AC/DC=10 times). When creep pulses cause a problem, solve the problem by increasing the initial speed or setting a minus value to the acceleration counter offset.

■ Example of Parameter Setting

As shown in Fig. 2.2-6, parameter setting of relative position driving in non-symmetry linear automatic acceleration / deceleration (acceleration < deceleration) is shown below.

Mode setting	WR3←0002h	Mode setting of WR3 register
Acceleration	AC = 36250	(30000-1000)/0.8 = 36250pps/sec
Deceleration	DC = 145000	(30000-1000)/0.2 = 145000pps/sec
Initial speed	SV = 1000	
Drive speed	DV = 30000	
Drive pulse number	TP = 27500	Relative position driving

2.2.4 S-curve Acceleration/Deceleration Driving [Symmetrical]

S-curve acceleration / deceleration driving performs acceleration and deceleration to a specified drive speed with a smooth curve that forms a secondary parabolic curve. This IC creates a S-curve by increasing/reducing acceleration/deceleration in a primary line at acceleration and deceleration of a drive speed.

Fig. 2.2-8 shows the operation of S-curve acceleration / deceleration driving where acceleration and deceleration are symmetrical.

- Section a. When driving starts, the acceleration increases on a straight line at a specified jerk. In this case, the speed data forms a quadratic curve.
- Section b. If the difference between a specified drive speed and the current speed becomes less than the speed that was utilized at acceleration increasing, the acceleration starts to decrease on a straight line at a specified jerk. The decrease ratio is the same as the increase ratio. In this case, the rate curve forms a parabola of reverse direction.
- Section c. When the speed reaches a specified drive speed or the acceleration reaches 0, the driving keeps that speed. In fixed pulse driving of S-curve acceleration / deceleration where acceleration and deceleration are symmetrical, when the rest of output pulses becomes less than the number of pulses that were utilized at acceleration, deceleration starts (automatic deceleration).
- Section d,e. Also in deceleration, the speed forms a S-curve by increasing/decreasing deceleration in a primary linear form.

The same operation is performed in acceleration/deceleration where the drive speed is changed during continuous pulse driving. However, in S-curve acceleration / deceleration driving, change of a drive speed during acceleration / deceleration is invalid.

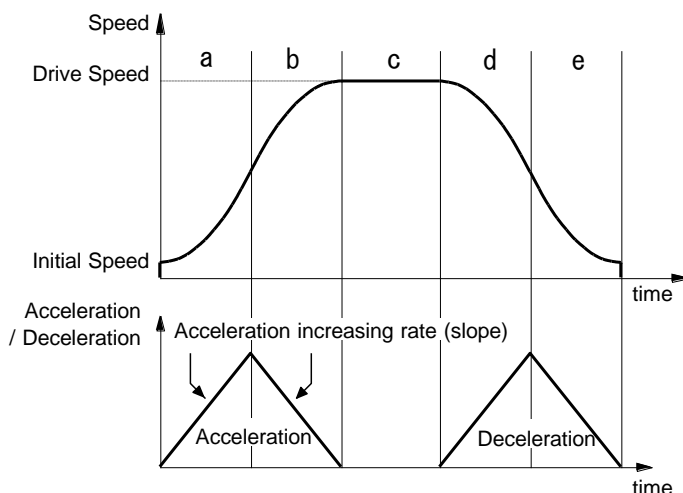

Fig. 2.2-8 S-curve Acceleration/Deceleration Driving (Symmetry)

To perform symmetry S-curve acceleration / deceleration driving using automatic deceleration, bits D2 to 0 of WR3 register and the following parameters must be set.

Table2.2-6 Mode Setting : S-curve Acceleration / Deceleration (Symmetry)

Mode Setting Bit	Symbol	Setting	Comment
WR3/D0	MANLD	0	Automatic deceleration
WR3/D1	DSNDE	0	When in deceleration, acceleration and jerk setting values are used.
WR3/D2	SACC	1	S-curve acceleration / deceleration

Table 2.2-7 Setting Parameters : S-curve Acceleration / Deceleration (Symmetry)

Parameter	Symbol	Comment
Jerk	JK	
Acceleration	AC	Set the maximum value : 536,870,911 (1FFF FFFFh).
Initial speed	SV	
Drive speed	DV	
Drive pulse number / Finish point	TP	Not required for continuous pulse driving.

■ Triangle Form Prevention of S-curve Acceleration / Deceleration Driving

S-curve acceleration / deceleration driving also has the triangle form prevention function for keeping a speed curve smooth. In fixed pulse driving of S-curve acceleration/deceleration where acceleration and deceleration are symmetrical, when the number of output pulses does not reach the number of pulses required for accelerating to a drive speed or when decelerating stop is performed during S-curve acceleration, the triangle form prevention function works in both cases and keeps a speed curve smooth.

<The Prevention of Triangle Driving Profile in Fixed Pulse Driving>

In fixed pulse driving of S-curve acceleration/deceleration where acceleration and deceleration are symmetrical, when the number of output pulses does not reach the number of pulses required for accelerating to a drive speed, the following method is applied to keep a speed curve smooth.

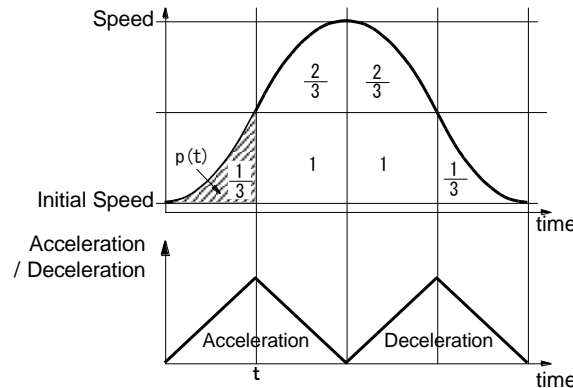

Fig. 2.2-9 The Rule of 1/12 of S-curve Acceleration / Deceleration

If the initial speed is "0" and the acceleration is increased up to the time "t" at a constant jerk "a", in the section of acceleration increasing, the speed "v(t)" in the time "t" can be expressed as follows.

$$v(t) = at^2 \quad a: \text{coefficient related to speed}$$

Therefore, the total number of pulses "p(t)" utilized during the time from "0" to "t" is the integral of the speed "v(t)" from the time "0" to "t".

$$p(t) = \frac{1}{3} \times at^3$$

This value indicates 1/3 of $at^2 \times t$ (the number of pulses of one square on the figure) regardless of the value of the jerk.

In fixed pulse driving, the acceleration is increased from the time "0" to "t" at a specified jerk, and is decreased from the time "t" at the same jerk. When the acceleration reaches 0, and if the deceleration is also increased / decreased at the same jerk, the number of pulses that were utilized in fixed pulse driving is expressed, as shown in Fig. 2.2-9, as follows.

$$\frac{1}{3} + \frac{2}{3} + 1 + 1 + \frac{2}{3} + \frac{1}{3} = 4 \text{ squares on the figure}$$

Therefore, the number of pulses (1/3 of a square) that were utilized during the time from "0" to "t" in acceleration increasing section is 1/12 of pulses that were utilized in all fixed pulse driving.

For this reason, in S-curve acceleration / deceleration fixed pulse driving, when the number of output pulses during acceleration is more than 1/12 of total output pulses, MCX514 will stop increasing acceleration and start to decrease the acceleration value with the speed curve as shown in Fig. 2.2-9. [Rule of 1/12]

This method makes an ideal curve when the initial speed is 0, however the initial speed cannot be 0, so the pulses from 0 on the figure to the initial speed will be excess and will be output at the peak of the speed.

<The Prevention of Triangle Driving Profile in Decelerating Stop>

In linear acceleration / deceleration driving, if the decelerating stop is commanded during acceleration, the speed curve forms a triangle form. In S-curve acceleration / deceleration driving, if the decelerating stop is commanded during acceleration as shown in Fig. 2.2-10, deceleration starts after the acceleration reaches 0.

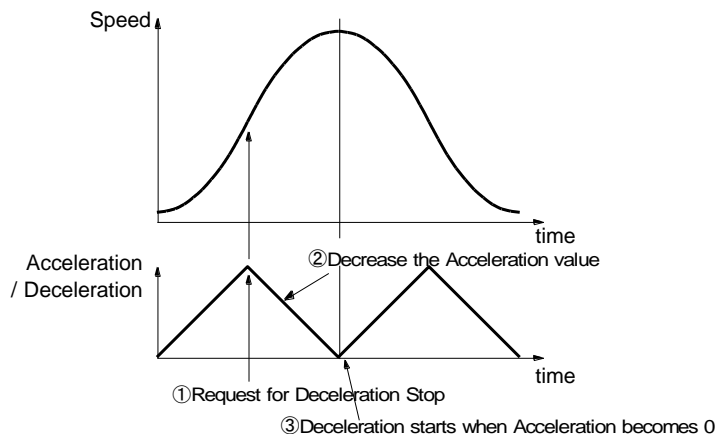

Fig. 2.2-10 Triangle Prevention of S-curve Acceleration / Deceleration by Decelerating Stop

■ Constraints for S-curve Acceleration / Deceleration Driving

- a. The drive speed cannot be changed during S-curve acceleration / deceleration fixed pulse driving.
- b. In S-curve acceleration / deceleration fixed pulse driving, if the drive pulse number is changed during deceleration, the S-curve profile cannot be exactly tracked.
- c. In S-curve acceleration / deceleration fixed pulse driving, if an extremely low value is set as the initial speed, premature termination (output of specified driving pulses is completed and terminated before the speed reaches the initial speed) or creep (output of specified driving pulses is not completed even if the speed reaches the initial speed and the rest of driving pulses is output at the initial speed) may occur.
- d. The drive speed can be changed during S-curve acceleration / deceleration continuous pulse driving. However, the command to change the drive speed during acceleration / deceleration will be invalid. To change the speed in S-curve acceleration / deceleration continuous pulse driving, make sure to change it during constant speed driving (RR3 register Page1 CNST=1). Speed increase / speed decrease (70h, 71h) commands and speed change by synchronous action will also be invalid.

■ Example of Parameter Setting (Symmetry S-Curve Acceleration / Deceleration)

The figure shown below is the example of S-curve acceleration that reaches from the initial speed 100pps to the drive speed 40kpps in 0.4 seconds.

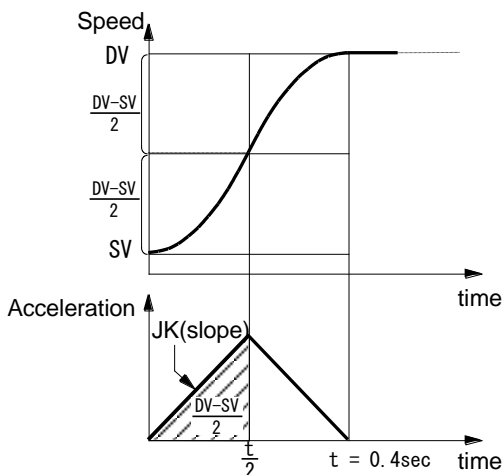

Fig. 2.2-11 Example of Symmetry S-Curve Acceleration / Deceleration Driving

At acceleration, acceleration is increased on a straight line based on a specified jerk (JK). The integral value (area indicated by diagonal lines) is the increased value of the speed from the initial speed “SV”.

Find the jerk (JK) to produce the result where the speed reaches a half ((DV-SV)/2) of the drive speed (DV) from the initial speed (SV) within a half (5/2) of the acceleration time (t=0.4sec). Use the following expression to find a value of “JK” since the area indicated by diagonal lines which uses “JK” in the left-hand member, is equal to the right-hand member.

$$\frac{1}{2} \times JK \times \left(\frac{t}{2}\right)^2 = \frac{DV - SV}{2}$$

$$JK = \frac{4(DV - SV)}{t^2}$$

$$JK = \frac{4(40000 - 100)}{0.4^2} = 997,500 \text{ pps/sec}^2$$

Jerk	JK [pps/sec ²]
Drive speed	DV [pps]
Initial speed	SV [pps]
Acceleration time	t [sec]

Therefore, the parameters for S-curve acceleration / deceleration driving with the acceleration as shown in Fig. 2.2-11 are as follows.

Mode Setting	WR3 ← 0004h	Mode setting of WR3 register
Jerk	JK = 997500	
Acceleration	AC = 536870911	Set the maximum value : (1FFF FFFFh)
Initial speed	SV = 100	
Drive speed	DV = 40000	
Drive pulse number	TP = 27500	Set when fixed pulse driving is performed.

■ Partial S-curve Acceleration / Deceleration

In acceleration / deceleration driving with a linear section of acceleration and deceleration, it is possible to form a smooth S-curve only in the start/end part of acceleration or deceleration. To set the speed parameter for acceleration and deceleration, specify not the maximum value but the value of acceleration and deceleration in a linear section of acceleration/deceleration.

As shown in Fig. 2.2-12, section b,f indicate a linear section of acceleration/deceleration and section a,c,e,g indicate S-curve section of acceleration/deceleration.

At section a, the acceleration increases on a straight line from 0 to the acceleration setting value and the speed curve forms a secondary parabolic curve. When the acceleration reaches the acceleration setting value, the acceleration keeps that value and the speed curve forms a straight line in the acceleration of section b. If the difference between a specified drive speed and the current speed becomes less than the speed that was utilized at acceleration increasing, the acceleration starts to decrease at a specified jerk and the speed curve forms a parabola of reverse direction at section c. Also in deceleration, it forms a partial S-curve of deceleration.

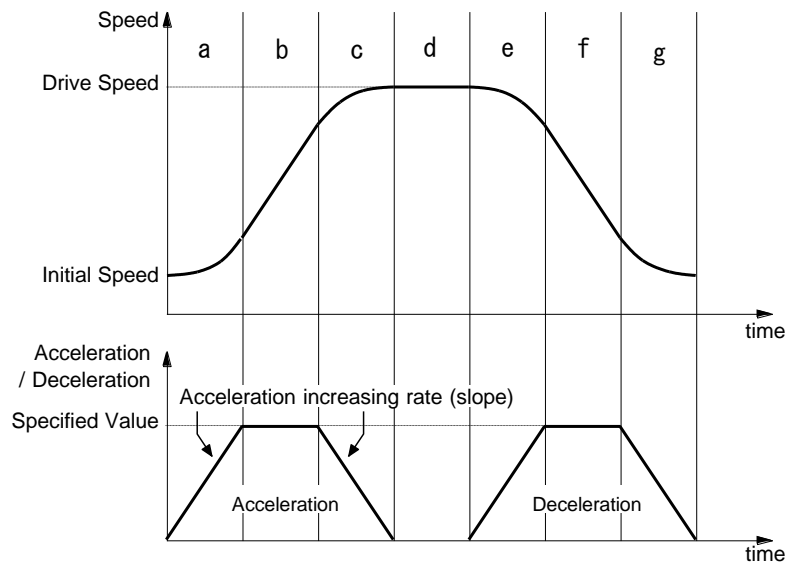

Fig. 2.2-12 Partial S-curve Acceleration / Deceleration Driving

■ Example of Parameter Setting (Partial S-curve Acceleration / Deceleration)

The figure shown below is the example of partial S-curve acceleration that reaches to 10kpps in 0.2 seconds by parabolic acceleration and then reaches from 10kpps to 30kpps in 0.2 seconds by acceleration on a straight line, finally reaches from 30kpps to 40kpps in 0.2 seconds by parabolic acceleration.

To simplify a calculation, suppose the initial speed is 0.

The acceleration increases to the first 10kpps in 0.2 seconds by parabolic acceleration on a straight line, and this integral value (area indicated by diagonal lines) corresponds to the rising speed 10kpps of the first parabolic acceleration. Therefore, the acceleration at 0.2 seconds is $10k \times 2 / 0.2 = 100kpps/sec$ and the jerk is $100k / 0.2 = 500kpps/sec^2$.

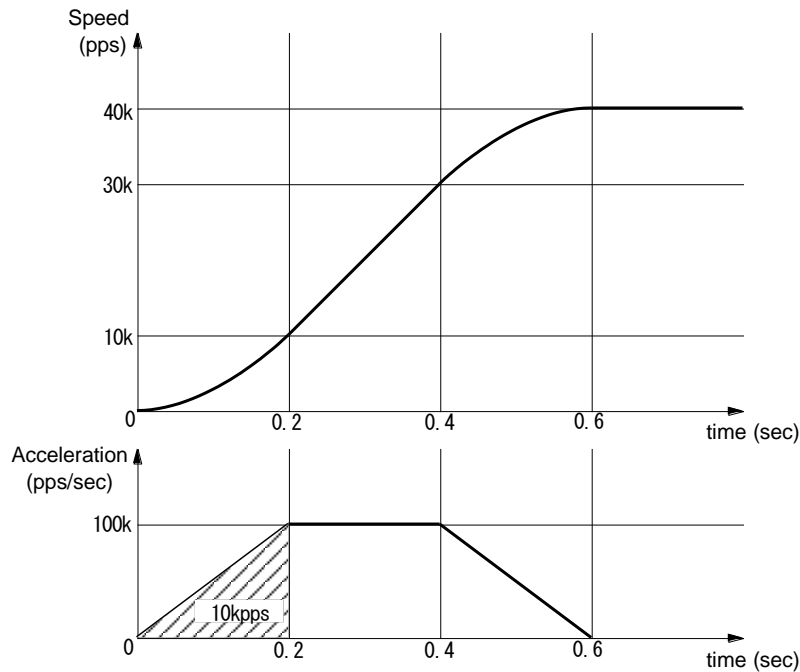

Fig. 2.2-13 Example of Partial S-curve Acceleration / Deceleration Driving

However the initial speed cannot be 0, the initial speed SV must be set the value larger than 0. In partial S-curve acceleration / deceleration, the initial speed SV should be the value more than a square root of acceleration AC.

Thus, with the acceleration as shown in Fig. 2.2-13, parameter setting of partial S-curve acceleration / deceleration driving is shown below.

Mode setting	WR3 ← 0004h	Mode setting of WR3 register
Jerk	JK = 500000	Set jerk for the section of parabolic acceleration (S-curve).
Acceleration	AC = 100000	Set Acceleration for the section of linear acceleration.
Initial speed	SV = 400	
Drive speed	DV = 40000	
Drive pulse number	TP = 40000	Set when fixed pulse driving is performed.

2.2.5 Non-symmetrical S-Curve Acceleration/Deceleration

In S-curve acceleration/deceleration driving, a non-symmetrical S-curve can be created by setting a jerk and a deceleration increasing rate individually. However, in non-symmetry S-curve acceleration/deceleration fixed pulse driving, a deceleration point must be specified manually because automatic deceleration is not available. Since a triangle form prevention function (1/12 rule) does not work either, a drive speed must be set according to the acceleration/ deceleration increasing rate and the number of output pulses for fixed pulse driving.

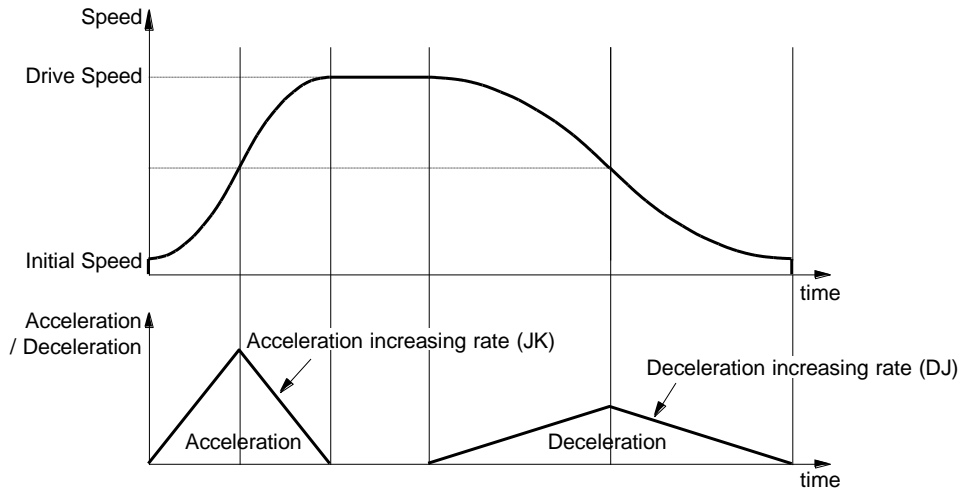

Fig. 2.2-14 Non-symmetry S-Curve Acceleration/Deceleration Driving

To perform non-symmetry S-curve acceleration / deceleration driving, bits D2 to 0 of WR3 register and the following parameters must be set.

Table 2.2-8 Mode Setting : Non-symmetry S-curve Acceleration / Deceleration

Mode Setting Bit	Symbol	Setting	Comment
WR3/D0	MANLD	1	Manual deceleration
WR3/D1	DSNDE	1	When in deceleration, deceleration setting value and deceleration increasing rate are used.
WR3/D2	SACC	1	S-curve acceleration / deceleration

Table 2.2-9 Setting Parameters : Non-symmetry S-curve Acceleration / Deceleration

Parameter	Symbol	Comment
Jerk	JK	
Deceleration increasing rate	DJ	
Acceleration	AC	Set the maximum value : 536,870,911 (1FFF FFFFh)
Deceleration	DC	Set the maximum value : 536,870,911 (1FFF FFFFh)
Initial speed	SV	
Drive speed	DV	
Drive pulse number / Finish point	TP	Not required for continuous pulse driving.
Manual deceleration point	DP	<ul style="list-style-type: none"> Set the value calculated by subtracting the number of pulses that were utilized at deceleration from the number of output pulses in fixed pulse driving. Not required for continuous pulse driving.

■ Example of Parameter Setting (Non-symmetry S-curve Acceleration / Deceleration)

The figure shown below is the example of non-symmetry S-curve acceleration / deceleration that reaches from the initial speed (SV) 100pps to the drive speed (DV) 40kpps in 0.2 seconds by acceleration, and decreases from the drive speed (DV) 40kpps to the initial speed (SV) 100pps in 0.4 seconds by deceleration. This is that drive pulse number (TP) is 20,000 and relative position driving.

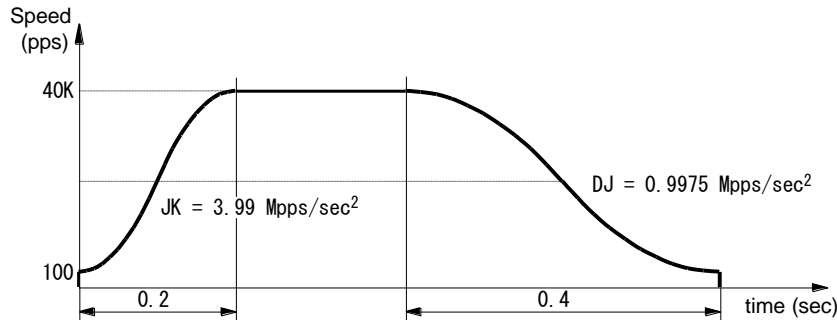

Fig. 2.2-15 Example of Non-symmetry S-Curve Acceleration/Deceleration Driving

Use the formula of the example of parameter setting (symmetry S-curve acceleration / deceleration) as described previously, and find a jerk and a deceleration increasing rate.

$$\text{Jerk} \quad JK = \frac{4(40000 - 100)}{0.2^2} = 3.99 \text{Mpps/sec}^2$$

$$\text{Deceleration increasing rate} \quad DJ = \frac{4(40000 - 100)}{0.4^2} = 0.9975 \text{Mpps/sec}^2$$

Next, set a deceleration point (DP) manually because automatic deceleration is not available in non-symmetry S-curve acceleration / deceleration. As a manual deceleration point, set the number of output pulses from the start of driving to the start of deceleration in fixed pulse driving. In relative position driving, it should be the value calculated by subtracting the number of pulses (Pd) that were utilized at deceleration from the number of drive pulses (TP), so first, find the number of pulses (Pd) that were utilized at deceleration.

$$\text{Pulses utilized at deceleration} \quad Pd = (DV + SV) \sqrt{\frac{DV - SV}{DJ}} = (40000 + 100) \sqrt{\frac{40000 - 100}{0.9975 \times 10^6}} = 8020$$

If the number of pulses (Pd) that were utilized at deceleration is 8,020 where the number of drive pulses (TP) is 20,000 in relative position driving, the manual deceleration point will be as follows.

$$\text{Manual deceleration point} \quad DP = TP - Pd = 20000 - 8020 = 11980$$

Therefore, parameter setting is shown below.

Mode setting	WR3←0007h	Mode setting of WR3 register
Jerk	JK = 3990000	
Deceleration increasing rate	DJ = 997500	
Acceleration	AC = 536870911	Set the maximum value : (1FFF FFFFh)
Deceleration	DC = 536870911	Set the maximum value : (1FFF FFFFh)
Initial speed	SV = 100	
Drive speed	DV = 40000	
Drive pulse number	TP = 20000	
Manual deceleration point	DP = 11980	

[Note]

- The above expression used for calculating the number of pulses that were utilized at deceleration is an ideal expression. In the actual IC operation, creep or premature termination occurs depending on the parameter values.

2.2.6 Pulse Width and Speed Accuracy

■ Duty Ratio of Drive Pulse

The period time of +/- direction pulse driving is decided by system clock SCLK. The tolerance is within ± 1 CLK (For CLK=16MHz, the tolerance is ± 62.5nsec). Basically, the duty ratio of each pulse is 50% as shown below. When the parameter setting is DV = 1000pps, the driving pulse is 500 μ sec on its Hi level and 500 μ sec on its Low level and the period is 1.00 msec.

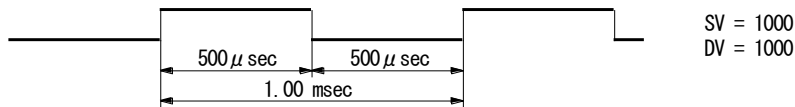

Fig. 2.2-16 High/Low Level Width of Driving Pulse Output (1000pps)

In acceleration / deceleration driving, the Low level pulse length is shorter than that of Hi level pulse during the acceleration; the Low level pulse is longer than that of Hi level pulse during the deceleration.

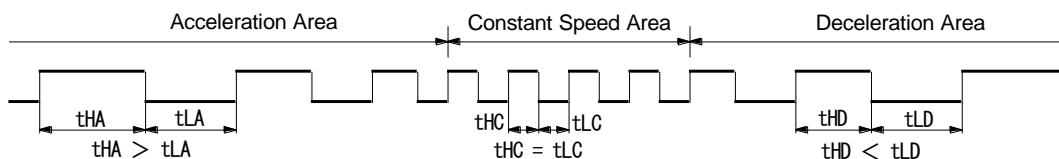

Fig. 2.2-17 Comparison of Drive Pulse Length in Acceleration / Deceleration

■ The Accuracy of Drive Speed

The circuits to generate drive pulses on MCX514 operate with input clock (CLK). If CLK input is standard 16MHz, the user had better drive the pulse speed in an exact multiple of CLK period (62.5nsec). However, in this case the frequency (speed) of driving pulse can only be generated by an exact multiple of CLK. For instance, double : 8.000 MHz, triple : 5.333 MHz, quadruple : 4.000 MHz, five times : 3.200 MHz, six times : 2.667 MHz, seven times : 2.286 MHz, eight times : 2.000 MHz, nine times : 1.778 MHz, 10 times : 1.600 MHz, Any fractional frequencies cannot be output. Therefore, MCX514 uses the following method to output any drive speed.

For instance, in the case of the drive speed DV = 980kpps, since this period is not an integral multiple of CLK period, pulses of 980kpps cannot be output under a uniform frequency. Therefore, as shown in the figure below, MCX514 combines 16 times and 17 times of CLK period in a rate of 674:326 to generate an average 980kpps.

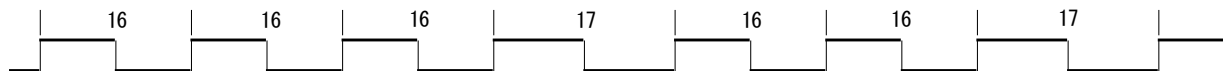

Fig. 2.2-18 The Driving Pulse of 980kpps

According to this method, MCX514 can generate a constant speed driving pulse in a very high accuracy. And speed accuracy of pulse output is ± 0.1% or less.

Using oscilloscope for observing the driving pulse, we can find the jitter about 1CLK (62.5nsec). This is no matter when putting the driving to a motor because the jitter will be absorbed by the inertia of motor system.

2.3 Position Control

MCX514 has two 32-bit up-and-down counters per axis for controlling the current position (logical position counter and real position counter), which can compare with the current position by presetting a value to a multi-purpose register. In addition, the software limit function and variable ring function can be set for the logical and real position counters.

2.3.1 Logical Position Counter and Real position Counter

The logical position counter counts driving pulses in MCX514. When one + direction pulse is output, the counter will count up 1, and when one - direction pulse is output, the counter will count down 1.

The real position counter counts input pulse numbers from external encoder. The type of input pulse can be selected from either quadrature pulses type or Up / Down pulse type. (See chapter 2.12.3)

The host CPU can read or write these two counters anytime. The counting range is between -2,147,483,648 ~ +2,147,483,647 and 2's complement is used for negative numbers. The values of the logical and real position counters are undefined at reset.

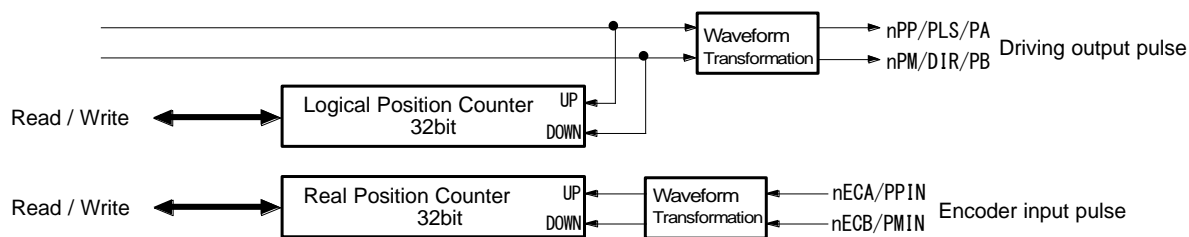

Fig. 2.3-1 Position Counter Functional Block Diagram

2.3.2 Position Comparison

MCX514 has four multi-purpose registers per axis, which can be used to compare with the current position of the logical and real position counters. The comparison result of a multi-purpose register with the logical / real position counter can be read out even while driving. And when it meets the comparison condition, a signal can be output, or an interrupt or synchronous action activation can be executed.

For more details of the multi-purpose register comparison functions, see chapter 2.4.

2.3.3 Software Limit

Software limit can be set for the logical position counter and real position counter in each axis. The object of software limit can be set by D14 bit of WR2 register. The software limit position of +/- direction is individually set for two 32-bit registers (SLMT+, SLMT-) which set the software limit.

When the value of the logical/real position counter that is set for the software limit becomes larger than the value of SLMT+ register, decelerating stop or instant stop is executed and D0 bit of RR2 register becomes 1. This error status will be cleared when the - direction driving command is executed and the value of the logical/real position counter is smaller than the value of SLMT+ register. It is the same with the SLMT- register of - direction.

In + direction software limit, if "position counter \geq SLMT+ value", software limit error occurs. In - direction software limit, if "position counter $<$ SLMT- value", software limit error occurs.

Fig. 2.3-2 is the example of SLMT+ register = 10000, SLMT- register = - 1000 and software limit function is enabled.

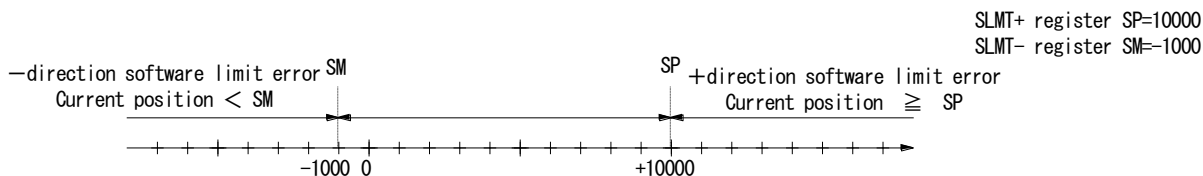

Fig. 2.3-2 Value Setting of Software Limit and Software Limit Error

Software limit function can be enabled /disabled by setting D13 bit of WR2 register. And there are two stop types of software limit, decelerating stop and instant stop, which is set by D15 bit of WR2 register. SLMT+ and SLMT- registers can be written anytime. Software limit function will be disabled and the values of SLMT+ and SLMT- registers will be undefined at reset.

2.3.4 Position Counter Variable Ring

A logical position counter and a real position counter are 32-bit up/down ring counters. Therefore, normally, when the counter value is incremented in the + direction from FFFF FFFFh which is the maximum value of the 32-bit length, the value is reset to 0. When the counter value is decremented in the - direction from 0, the value is reset to FFFF FFFFh. The variable ring function enables the setting of any value as the maximum value. This function is useful for managing the position of the axis in circular motions that return to the home position after one rotation, rather than linear motions.

The variable ring size, that is the maximum value of the logical / real position counter can be set with any value within the range of 1~2,147,483,647 (1~7FFF FFFFh). To use the variable ring function, set the logical position counter maximum value (LX) by logical position counter maximum value setting command (0Eh) and set the real position counter maximum value (RX) by real position counter maximum value setting command (0Fh).

The value of the logical position counter maximum value (LX) and real position counter maximum value (RX) will be FFFF FFFFh at reset. When not using the variable ring function, leave it at default.

■ Example of Variable Ring Setting

For instance, set as follows for a rotation axis that rotates one cycle with 10,000 pulses.

- ① Set 9,999 (270Fh) in the logical position counter maximum value (LX).
- ② Set 9,999 (270Fh) in the real position counter maximum value (RX) also if using a real position counter.

The count operation will be as follows.

- Increment in the + direction : ...→9998→9999→0→1→...
- Decrement in the - direction : ...→1→0→9999→9998→...

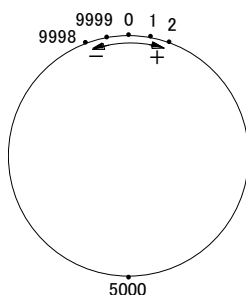

Fig. 2.3-3 Operation of Position Counter Ring Maximum Value 9999

[Note]

- It is possible to set the value within the range of 1~2,147,483,647 (1~7FFF FFFFh) as the maximum value of the variable ring function. The signed negative value (8000 0000h~FFFF FFFEh) of a 32-bit register cannot be set.
- When setting values to the logical position counter (LP) and real position counter (RP), the values out of the range of the logical position counter maximum value (LX) and the real position counter maximum value (RX) cannot be set.

2.4 Multi-Purpose Register

MCX514 has four signed 32-bit multi-purpose registers (MR3~0) per axis.

Multi-purpose register can be used to compare with the current position, speed and timer, and then can read out the status which represents comparison result and can output as a signal. In addition, it can activate a synchronous action according to comparison result and can generate an interrupt. As an action of a synchronous action, it can load the values pre-set to multi-purpose registers as a new speed or drive pulse number, and can save the current position or speed to multi-purpose registers.

Multi-purpose registers can be written / read anytime, by using each multi-purpose register setting command (10h~13h) and multi-purpose register reading command (34h~37h).

The values of multi-purpose registers are undefined at reset.

2.4.1 Comparative Object and Comparison Condition

As the comparative objects of multi-purpose registers (MR3~0), the values of the logical position counter, real position counter, current drive speed and timer can be set. The comparison condition expression to the comparative object can be selected from \geq , $>$, $=$, $<$.

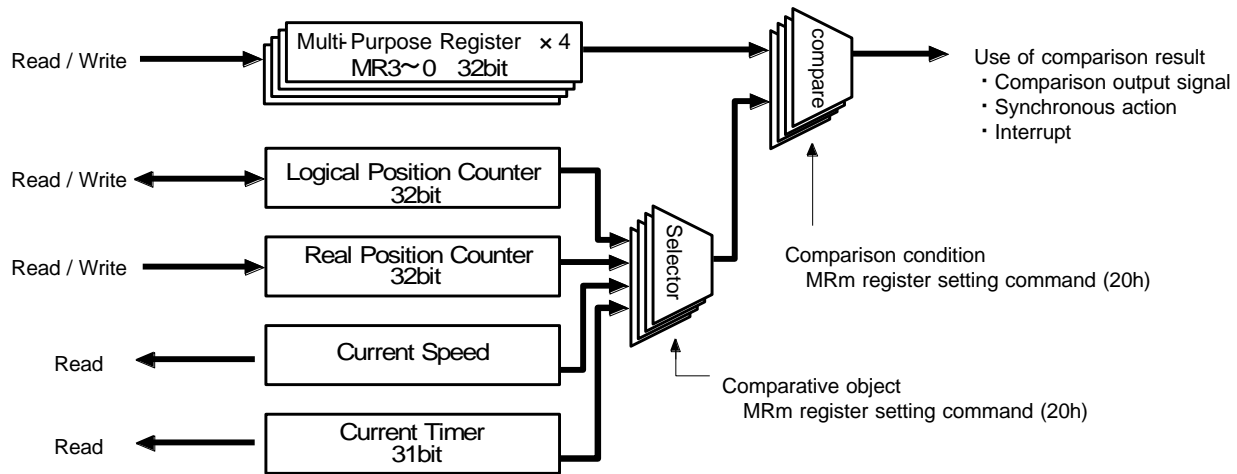

Fig. 2.4-1 Multi-Purpose Registers and Compare Function

The user can set the comparative object and comparison condition to four multi-purpose registers individually by using multi-purpose register mode setting command (20h). Set specified bits of WR6 data writing register and write multi-purpose register mode setting command (20h) to WR0 register, and then they will be set.

Multi-purpose register mode setting can be read out by multi-purpose register mode setting reading command (40h).

Multi-purpose register mode setting command (20h)

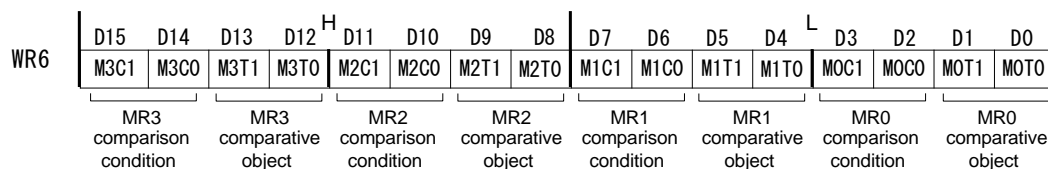

Table 2.4-1 Setting of Comparative Object

(k:0~3)		
MkT1 bit	MkT0 bit	MRm Comparative Object
0	0	Logical position counter (LP)
0	1	Real position counter (RP)
1	0	Current drive speed value (CV)
1	1	Current timer value (CT)

Table 2.4-2 Setting of Comparison Condition

(n:0~3)		
MkC1 bit	MkC0 bit	MRm Comparative Object
0	0	Comparative object \geq MRm
0	1	Comparative object $>$ MRm
1	0	Comparative object $=$ MRm
1	1	Comparative object $<$ MRm

[Note]

- When the comparative object is set as "current drive speed value (CV)" and comparison condition is set as "comparative object = MRm", if the acceleration/deceleration exceeds 4,194,304 (400000h) pps/sec in linear and S-curve acceleration/deceleration driving, the comparison result may not become TRUE (active).
When the comparative object is "current drive speed value (CV)" and the acceleration/deceleration is more than this value, set the other conditions such as "comparative object \geq MRm" and not "comparative object = MRm".

■ Example: Comparison with Logical Position Counter

When the logical position counter value of X axis is larger than 500,000 and if the user wants the comparison result is TRUE, set as follows.

WR6 ← A120h		
WR7 ← 0007h	MR0 : Set 500,000	⇨ Set the value to MR0
WR0 ← 0110h		
WR6 ← 0000h	D3,D2 : 0,0 Comparison condition : \geq	
	D1,D0 : 0,0 Comparative object :	⇨ Set comparative object and comparison condition of MR0
	Logical position counter (LP)	
WR0 ← 0120h	Writes multi-purpose register mode setting	

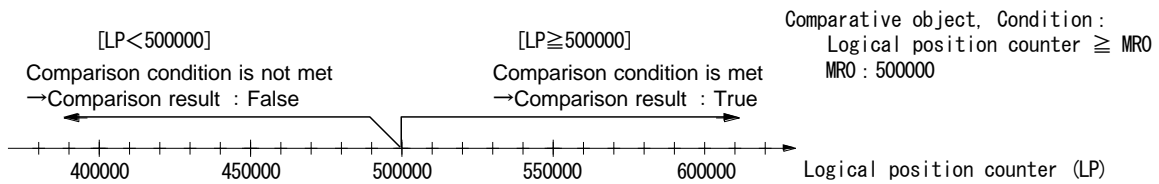

Fig. 2.4-2 Comparison Example of Multi-Purpose Register with Logical Position Counter

2.4.2 Usage of Comparison Result

The user can use the comparison result of comparative object with a multi-purpose register as a comparison output signal, synchronous action activation and interruption factor. The functions to use the comparison result and actions are as follows.

Table 2.4-3 Usage of Comparison Result and Actions

Function	Object	Action
Comparison output signal	nPIO7~4 Output signals	When comparison result is TRUE, output signal is Hi.
Synchronous action activation	Synchronous action SYNC3~0	When comparison result changes to TRUE, synchronous action is activated.
Interruption factor	Interrupt function	When comparison result changes to TRUE, interrupt occurs.

■ Comparison Output Signal

The user can output the comparison result of a multi-purpose register as a comparison output signal. When the comparison result of a multi-purpose register meets a specified comparison condition, the comparison output signal outputs Hi level, and when does not meet it, the comparison output signal outputs Low level.

The comparison results of multi-purpose registers (MR3~0) are output to each corresponding comparison output signal nPIO7~4. nPIO7~4 signals share the other signals such as the general purpose input / output signals. To use them as comparative output pins, the user needs to set the function of nPIO7~4 signals to the comparison output signal by using PIO signal setting 1 command (21h) in advance.

Table 2.4-4 Comparison output signal and Bit corresponding to Multi-purpose Register

Multi-purpose register	Comparison output signal	PIO signal setting 1 command (21h) Setting bit of WR6 register
MR0	nPIO4	WR6/D9 ,8 : 1,1
MR1	nPIO5	WR6/D11,10 : 1,1
MR2	nPIO6	WR6/D13,12 : 1,1
MR3	nPIO7	WR6/D15,14 : 1,1

For more details of the general purpose nPIOm signal, see chapter 2.8.

■ Example: Comparison Output Signal

When the current drive speed exceeds 5,000pps during the driving of X axis, Hi is output to XPIO5 output signal and when it is 5,000pps or less, Low is output to XPIO5 output signal.

WR6 ← 1388h			
WR7 ← 0000h	MR1 : Set 5,000		⇐ Set the value to MR1
WR0 ← 0111h			
WR6 ← 0060h	D7,D6 : 0,1 D5,D4 : 1,0	Comparison condition : > Comparative object : Current drive speed (CV)	⇐ Set comparative object and comparison condition of MR1
WR0 ← 0120h	Writes multi-purpose register mode setting		
WR6 ← 0C00h	D11,D10 : 1,1	XPIO5 Function : MR1 comparison output	⇐ Set the function of XPIO5 signal
WR0 ← 0121h	Writes PIO signal setting 1		

■ Synchronous Action Activation

Synchronous action can be activated according to the comparison result of a multi-purpose register. When the comparison result of a multi-purpose register changes to meet a specified comparison condition, the synchronous action is activated. If it already meets the comparison condition when the synchronous action is enabled, the synchronous action is not activated at that time. After it returns to False, if the comparison result of a multi-purpose register again changes to meet a specified comparison condition, the synchronous action will be activated.

The synchronous action activation according to the comparison result of multi-purpose register MR3~0 can be set as the activation factor of each corresponding synchronous action set SYNC3~0. To use the comparison result of a multi-purpose register as the activation factor of a synchronous action, first set the activation factor of a synchronous action set which the user wants to use to "MRm comparison changed to True" (activation factor code : 01h) by synchronous action SYNC0, 1, 2, 3 setting commands(26h, 27h, 28h, 29h), and then enable the synchronous action set by using synchronous action enable setting command (81h~8Fh).

Table 2.4-5 Synchronous Action Set and Setting Command Corresponding to Multi-purpose Register

Multi-purpose Register	Synchronous Action Set	Synchronous Action Setting Command to set Activation Factor
MR0	SYNC0	Synchronous action SYNC0 setting command (26h)
MR1	SYNC1	Synchronous action SYNC1 setting command (27h)
MR2	SYNC2	Synchronous action SYNC2 setting command (28h)
MR3	SYNC3	Synchronous action SYNC3 setting command (29h)

In addition to the activation factor, synchronous action SYNC0, 1, 2, 3 setting commands set other actions and repeat behavior

for synchronous actions.

For more details of the synchronous action functions and settings, see chapter 2.6.

■ Example: Synchronous Action Activation

While 10 seconds timer is running, to activate relative position driving in X axis after 5 seconds from timer-start by synchronous action SYNC2, set as follows.

The timer activates the synchronous action after 5 seconds from timer-start and is up after 10 seconds.

WR6 ← 4B40h			
WR7 ← 004Ch	MR2 : Set 5,000,000		↩ Set the value to MR2
WR0 ← 0112h	(5 seconds = 5,000,000μsec)		
<hr/>			
WR6 ← 9680h			
WR7 ← 0098h	Timer : Set 10,000,000		↩ Set 10 seconds as the timer value
WR0 ← 0116h	(10 seconds = 10,000,000)		
<hr/>			
WR6 ← 0300h	D11,D10 : 0,0 Comparison condition : ≧ D9,D8 : 1,1 Comparative object : Current timer value (CT)		↩ Set comparative object and comparison condition of MR2
<hr/>			
WR0 ← 0120h	Writes multi-purpose register mode setting		
WR6 ← 00A1h	Activation factor code 01h : MR2 comparison changed to True		↩ Set the function of SYNC2
<hr/>			
WR0 ← 0128h	Writes synchronous action SYNC2 setting		
WR0 ← 0184h	Synchronous action SYNC2 enable setting command		↩ Set to enable SYNC2

※ Parameters for relative position driving must be set in advance.

For more details of the relative position driving, see chapter 2.1.1.

■ Generating an Interrupt

The user can generate an interrupt according to the comparison result of a multi-purpose register. When the comparison result of a multi-purpose register changes to meet a specified comparison condition, an interrupt occurs. If it already meets the comparison condition when an interrupt is enabled, an interrupt does not occur at that time. After it returns the state not to meet a specified comparison condition, if the comparison result of a multi-purpose register again changes to meet the specified comparison condition, an interrupt will occur.

To generate an interrupt according to the comparison result of multi-purpose register MR3~0, the user needs to set interrupt of the multi-purpose register comparison as enable to each bit of the interrupt factor of WR1 mode register 1 in advance. The interrupt factor of when an interrupt occurs can be checked by the interrupt factor check bit of RR1 Status register 1.

Table 2.4-6 Interrupt Enable and Check Bit corresponding to Comparison Result of Multi-purpose Register

Multi-purpose Register	Interrupt Enable Bit	Interrupt Factor Check Bit
MR0	WR1/D0 : 1	RR1/D0 : 1
MR1	WR1/D1 : 1	RR1/D1 : 1
MR2	WR1/D2 : 1	RR1/D2 : 1
MR3	WR1/D3 : 1	RR1/D3 : 1

For more details of the interrupt, see chapter 2.10.

■ Example: Interrupt

When the real position counter value is passing through 30,000, an interrupt occurs in X axis.

WR6 ← 7530h			
WR7 ← 0000h	MR3 : Set 30,000		↩ Set the value to MR3
WR0 ← 0112h			
<hr/>			
WR6 ← 0060h	D15,D14 : 1,0 Comparison condition : = D13,D12 : 0,1 Comparative object : Real position counter (RP)		↩ Set comparative object and comparison condition of MR3
<hr/>			
WR0 ← 0120h	Writes multi-purpose register mode setting		
WR0 ← 011Fh	Assign X axis (NOP command)		↩ Set the interrupt factor
WR1 ← 0008h	Interrupt Factor : Enable MR3 comparison changed to True		

2.4.3 Load / Save of Parameters by Synchronous Action

By using the synchronous action, the user can load the value pre-set to a multi-purpose register as a new speed or drive pulse number, and save the current position and a speed to a multi-purpose register.

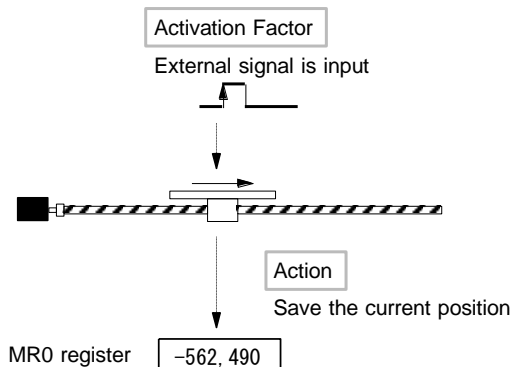

Fig. 2.4-3 Usage Example of Saving Parameters

There are 7 kinds of parameters that are loadable from the multi-purpose register by using the synchronous action and 5 kinds of parameters that can be saved to the multi-purpose register. Load / save of parameters will be executed to the multi-purpose register according to the synchronous action SYNC3~0 activation.

To load /save the parameters by using the synchronous action, the user needs to set the action code for the action of the synchronous action set which the user wants to use by executing synchronous action SYNC3~0 setting command (26h,27h,28h,29h). And the synchronous action set which the user wants to use must also be enabled by synchronous action enable setting command (81h~8Fh).

Table 2.4-7 Parameter Loaded / Saved by Synchronous Action

Action Code (Hex)	Loadable Parameter (Load)	Action Code (Hex)	Save the Current Value (Save)
01	Drive speed (DV)	05	Logical position counter (LP)
02	Drive pulse number / Finish point (TP)	06	Real position counter (RP)
03	Split pulse setting 1 (SP1)	07	Current timer value (CT)
04	Logical position counter (LP) (SYNC0)	08	Current drive speed (CV) (SYNC0)
	Real position counter (RP) (SYNC1)		Current acceleration / deceleration (CA) (SYNC1)
	Initial speed (SV) (SYNC2)		
	Acceleration (AC) (SYNC3)		
0F	Set drive pulse number (TP), and start relative position driving		
10	Set finish point (TP), and start absolute position driving		

Action Code (Hex) : Code that is set to the data writing register of synchronous action SYNC0,1,2,3 setting commands.

For more details of the load/save parameters to the multi-purpose register by using the synchronous action, see chapter 2.6.

2.5 Automatic Home Search

This IC has a function that automatically executes a home search sequence such as high-speed home search → low-speed home search → encoder Z-phase search → offset drive without CPU intervention. The automatic home search function sequentially executes the steps from Step1 to Step4 that are listed below. The user can select execution or non-execution for each step. If non-execution is selected, it proceeds with next step without executing that step. And for each step, the user sets a search direction and a detection signal by mode setting. In steps 1 and 4, search operation or driving is performed at the high-speed that is set as the drive speed. In Steps 2 and 3, search operation is performed at the low-speed that is set as the home search speed. In addition in Steps 2 and 3, it is possible to output nDCC (deviation counter clear signal) or clear the real/logical position counter when the signal is detected. The timer between steps can be used at the end of each step.

Table 2.5-1 Details of Automatic Home Search Sequence

Step number	Operation	Search speed	Detection signal
Step 1	High-speed home search	Drive speed (DV)	Specify any one of nSTOP0, nSTOP1 and Limit
Step 2	Low-speed home search	Home search speed (HV)	Specify either nSTOP1 or Limit
Step 3	Low-speed Z-phase search	Home search speed (HV)	nSTOP2
Step 4	High-speed offset drive	Drive speed (DV)	—

Generally, automatic home search has various operations according to the detection signal that is used. As shown in the following examples, there are some cases of a home search, such as using two sensors, a near home signal and a home signal, and using only a home signal or only one limit signal.

(1) Example of the home search using a near home signal (nSTOP0) and a home signal (nSTOP1)

It searches a near home signal at high-speed in a specified direction, and then if a near home signal is detected, it performs decelerating stop. Next, it searches a home signal at low-speed, and then if a home signal is detected, it performs instant stop.

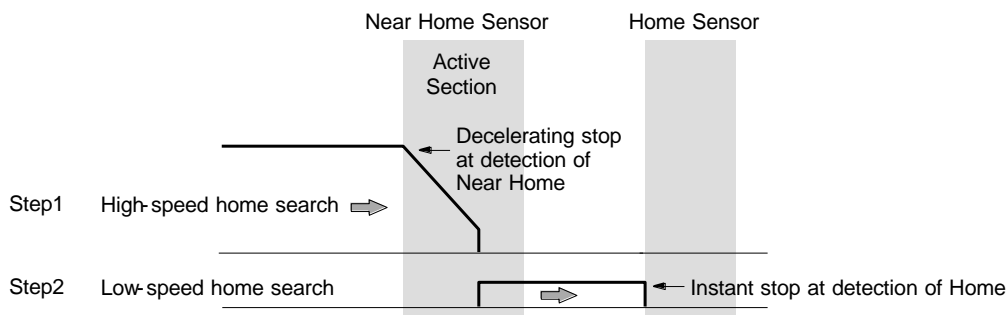

Fig. 2.5-1 Example 1 of Automatic Home Search

(2) Example of the home search using only a home signal (nSTOP1) or only one limit signal (nLMTP/nLMTM)

It searches a home signal or a limit signal at high-speed in a specified direction, and then if a signal is detected, it performs decelerating stop. Next, it escapes in the opposite direction from the signal active section, and then searches a home signal at low-speed, and if a home signal is detected, it performs instant stop. If a limit signal is used as a detection signal, it becomes the limit signal of a search direction.

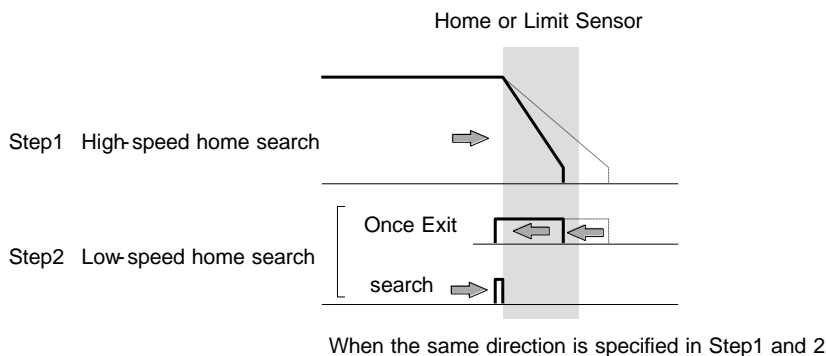

Fig. 2.5-2 Example 2 of Automatic Home Search

This IC provides several mode settings in response to these various home search operations.

2.5.1 Operation of Each Step

In each step, the user can specify execution/non-execution, the $+/-$ search direction and a detection signal by mode setting. If non-execution is specified, it proceeds with next step without executing that step.

■ Step 1: High-speed home search

Drive pulses are output in a specified direction at the speed set as the drive speed (DV) until the specified detection signal becomes active. The user can specify any one of nSTOP0, nSTOP1 and limit signals as the detection signal. If a limit signal is selected, it becomes the limit signal of a search direction.

To perform high-speed search operation, set the drive speed (DV) higher than the initial speed.

Acceleration/deceleration driving is performed and when the specified signal becomes active, the operation stops by deceleration.

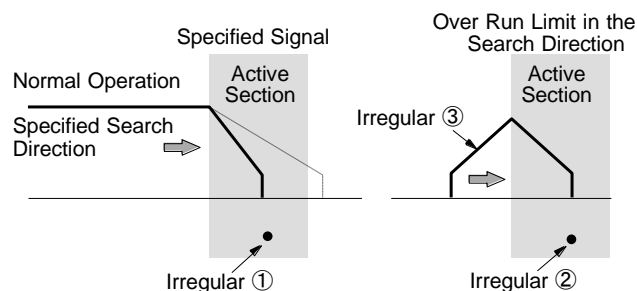

Fig. 2.5-3 Operation of Step 1

Irregular operation

- ① A specified detection signal is already active before Step 1 starts. → Proceeds with Step 2.
- ② When nSTOP0 or nSTOP1 is specified as a detection signal and a limit signal in the search direction is already active before Step 1 starts. → Proceeds with Step 2.
- ③ When nSTOP0 or nSTOP1 is specified as a detection signal, and a limit signal in the search direction is activated during execution. → Stops driving and proceeds with Step 2.

Other operations in Step 1

At the end of Step 1, the timer between steps can be used. For more details, see chapter 2.5.3.

[Note]

- Since Step 1 performs a high-speed search, if the user specifies a limit signal as a detection signal, the limit stop mode must be set as decelerating stop mode (WR2/D12 : 1). For more details of the WR2 register, see chapter 6.6.

Step 2: Low-speed home search

Drive pulses are output in a specified direction at the speed set as the home search speed (HV) until the specified detection signal becomes active. The user can specify either nSTOP1 or limit signal as a detection signal. If a limit signal is selected, it becomes the limit signal of a search direction. To perform low-speed search operation, set the home search (HV) lower than the initial speed (SV). A constant speed driving mode is applied and when a specified signal becomes active, the operation stops instantly

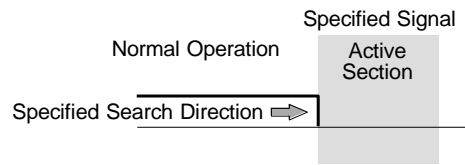

Fig. 2.5-4 Operation of Step 2

Irregular operation

① A specified signal is already active before Step 2 starts.

[Behavior]

The motor drives the axis in the direction opposite to a specified search direction at the home search speed (HV) until a specified signal becomes inactive. When a specified signal becomes inactive, the function executes Step 2 normal operation from the beginning.

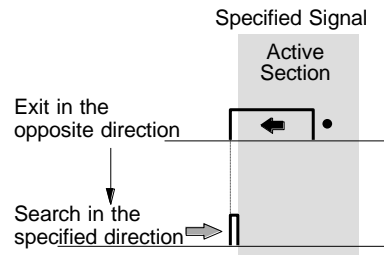

Fig. 2.5-5 Irregular Operation ① of Step 2

② When nSTOP1 is specified as a detection signal and a limit signal in the search direction is active before Step 2 starts.

[Behavior]

The motor drives the axis in the direction opposite to a specified search direction at the drive speed (DV) until nSTOP1 signal becomes active. When nSTOP1 signal becomes active, the motor drives in the direction opposite to a specified search direction at the home search speed (HV) until nSTOP1 signal becomes inactive. When nSTOP1 signal becomes inactive, the function executes Step 2 normal operation from the beginning.

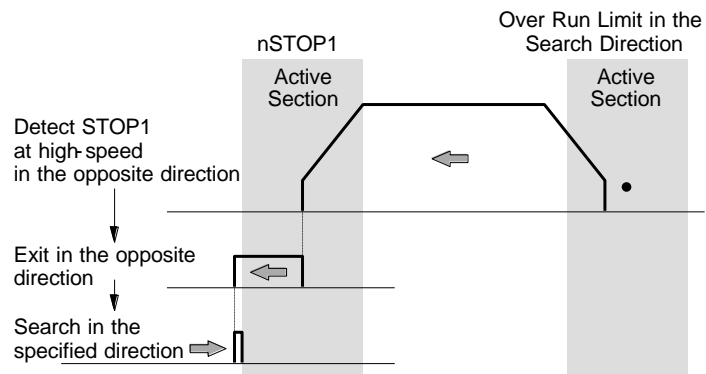

Fig. 2.5-6 Irregular Operation ② of Step 2

③ When nSTOP1 is specified as a detection signal and a limit signal in the search direction becomes active during execution.

[Behavior]

Driving stops and the operation described in Irregular operation ② is performed.

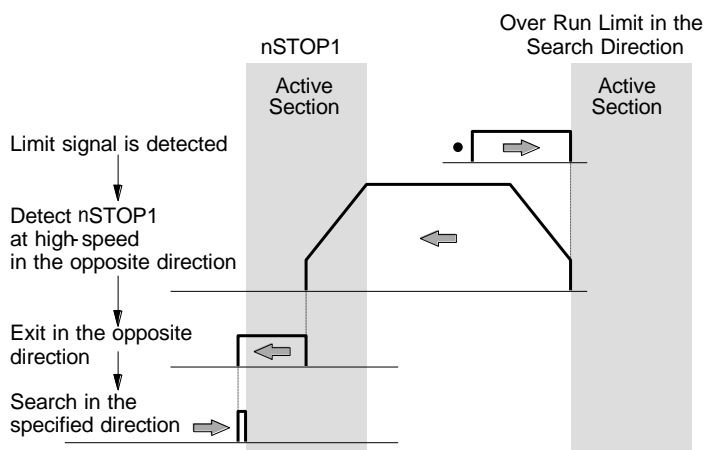

Fig. 2.5-7 Irregular Operation ③ of Step 2

④ When a detection signal is the same in Step 1 and Step 2 and a search direction is also the same in Step 1 and Step 2, and a specified signal is inactive before Step 2 starts.

[Behavior]

The operation described in Irregular operation ② is performed.

This operation is appropriate to the home search for a rotation axis.

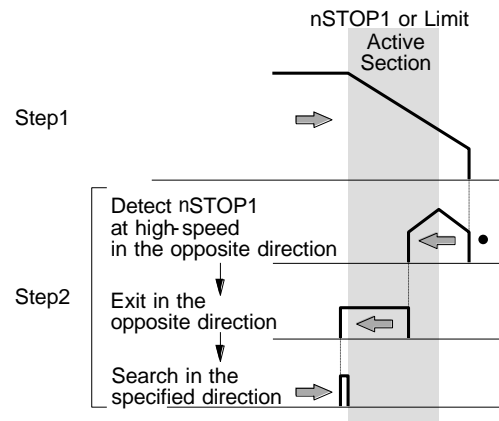

Fig. 2.5-8 Irregular Operation ④ of Step 2

Other operations in Step 2

While searching in a specified direction, when the detection signal of Step 2 changes from inactive to active, it is possible to output deviation counter clear signal (nDCC) or clear the real/logical position counter. However during the irregular operation, if the detection signal changes to active while the motor drives the axis in the direction opposite to a specified search direction, these will not work. For more details of the deviation counter clearing (nDCC) signal output, see chapter 2.5.2.

In addition to at the end of Step 2, the timer between steps can be used after it escapes in the opposite direction of the irregular operation ①~④.

■ Step 3: Low-speed Z-phase search

Drive pulses are output in a specified direction at the speed set as the home search speed (HV) until the encoder Z-phase signal (nSTOP2) becomes active. To perform low-speed search operation, set the home search speed (HV) lower than the initial speed (SV). A constant speed driving mode is applied and when the encoder Z-phase signal (nSTOP2) becomes active, driving stops instantly.

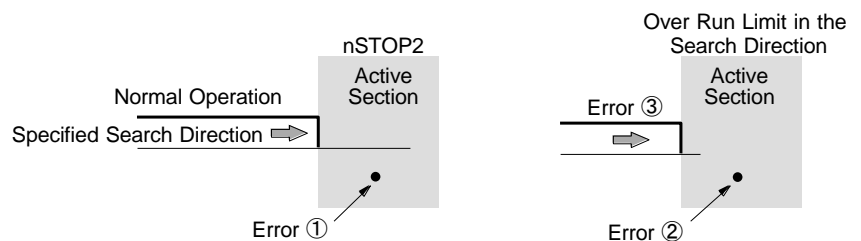

Fig. 2.5-9 Operation of Step 3

As a search condition, the AND condition of the encoder Z-phase signal (nSTOP2) and the home signal (nSTOP1) can be applied to stop driving.

Other operations in Step 3

When the encoder Z-phase signal (nSTOP2) changes to active, it is possible to clear the real/logical position counter. The real position counter can clear its counter without CPU intervention if nSTOP2 is active. This function is useful for solving the problem of Z-phase detection position slippage that occurs due to a delay of the servo system or the mechanical system when Z-phase search drive is set at low-speed.

When the encoder Z-phase signal (nSTOP2) changes to active, it is also possible to output deviation counter clear signal (nDCC). And the timer between steps can be used at the end of Step 3.

[Note]

- ① If the encoder Z-phase signal (nSTOP2) is already active at the start of Step 3, an error occurs and 1 is set to D6 bit of R2 register. Automatic home search ends. Adjust the mechanical system so that Step 3 always starts from an inactive state that the encoder Z-phase signal (nSTOP2) is stable.
- ② If the limit signal in the search direction is already active before the start of Step 3, an error occurs and 1 is set to the search direction limit error bit (D2 or D3) of RR2 register. Automatic home search ends.
- ③ If the limit signal in the search direction becomes active during execution, search operation is interrupted and 1 is set to the search direction limit error bit (D2 or D3) of RR2 register. Automatic home search ends.

■ Step 4: High-speed offset drive

Drive pulses set as the drive pulse number (TP) are output at the speed set as the drive speed (DV) by relative position driving. This step 4 is normally used to move the axis from the mechanical home position to the operation home position. If a limit signal is selected as a detection signal, it is used to keep the operation home position away from the limit a little bit. If the limit signal of a drive direction becomes active before Step 4 starts or during execution, the operation stops due to an error and 1 is set to the search direction limit error bit (D2 or D3) of RR2 register. Automatic home search ends.

2.5.2 Deviation Counter Clearing Signal Output

In Step2 or Step3, when a specified detection signal (fixed to nSTOP2 in Step 3) rises to active, it is possible to output the deviation counter clear signal (nDCC). And the logical level of deviation counter clear pulses and pulse width can be set. For more details, see chapter 2.5.4.

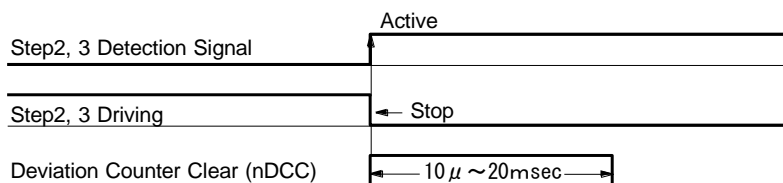

Fig. 2.5-10 Deviation Counter Clearing Signal Output

Deviation counter clearing output becomes active at the termination of search operation in Step 2 or Step 3, and next step starts after the completion of deviation counter clear (nDCC) pulses output.

2.5.3 Timer Between Steps

Each step for an automatic home search has the setting which reverses the motor. If the motor reverses suddenly, it may overload the mechanical system. The timer between steps helps to reduce the load on the mechanical system.

This IC can use the timer between steps at the end of each step. About Step 2, the timer between steps can be used after a specified irregular operation.

The user can set the use/nonuse of the timer between steps and timer value. For more details, see chapter 2.5.4.

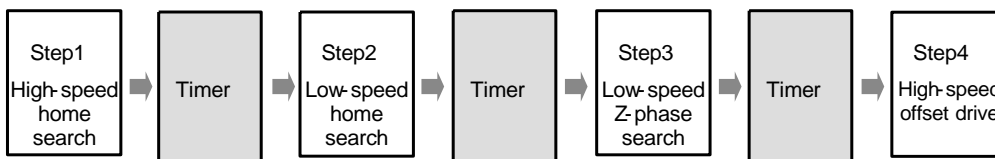

Fig. 2.5-11 Timer Between Steps

When the timer between steps is enabled, the timer starts at the end of each step and next step starts after the timer operation. About Step 2, if a specified irregular operation occurs, the timer between steps starts there too, and Step2 normal operation starts after the timer operation. For more details of the Step 2 irregular operation, see chapter 2.5.1.

[Note]

- The timer between steps cannot be set for each step individually. If enabled, all the timers which are between steps and after the specified irregular operation of Step 2 are all enabled, and the timer starts according to a specified timer value. If disabled, all the timers between steps are disabled.

2.5.4 Setting a Search Speed and a Mode

To perform an automatic home search, the following speed parameters and mode must be set.

■ Setting speed parameters

Table 2.5-2 Setting Speed Parameters

Speed parameter	Command code (hex)	Description
Drive speed (DV)	0 5	High-speed search and drive speed that is applied in Steps 1 and 4. However in irregular operation of Step 2, when the user searches in the direction opposite to a specified search direction, this drive speed is applied. Acceleration (AC) and initial speed (SV) must also be set with appropriate values to perform acceleration/deceleration driving. See chapter 2.2.2.
Home search speed (HV)	1 4	Low-speed search speed that is applied in Steps 2 and 3. Set a value lower than the initial speed (SV) to stop instantly when a search signal becomes active. See chapter 2.2.1.

■ Automatic home search mode setting 1

Automatic home search mode setting 1 can be set by setting each bit of WR6 register as shown below and then writing automatic home search mode setting 1 command (23h) into WR0 register. It specifies execution/non-execution of each step, detection signal, search direction, deviation counter clear output and logical/real position counter clear.

WR6	D15	D14	D13	D12 ^H	D11	D10	D9	D8	D7	D6	D5	D4 ^L	D3	D2	D1	D0
	S4EN	S3LC	S3RC	S3DC	S3DR	S3EN	S2LC	S2RC	S2DC	S2SG	S2DR	S2EN	S1G1	S1G0	S1DR	S1EN

① Execution/non-execution of each step

Specify whether operation of each step is executed. 0: Non-execution, 1: Execution

The specified bit for execution / non-execution in each step is shown in the table below.

Table 2.5-3 Execution / Non-execution Specified Bit in Each Step

	Step 1	Step 2	Step 3	Step 4	
Execution / Non-execution Specified Bit	D0 bit S1EN	D4 bit S2EN	D10 bit S3EN	D15 bit S4EN	0: Non-execution 1: Execution

② Search direction of each step

Specify the search direction of a detection signal in each step. 0: + direction, 1: - direction

The specified bit for a search direction in each step is shown in the table below.

Table 2.5-4 Search Direction Specified Bit in Each Step

	Step 1	Step 2	Step 3	Step 4	
Search Direction Specified Bit	D1 bit S1DR	D5 bit S2DR	D11 bit S3DR	—	0: + direction 1: - direction

③ Detection signal of each step

Step 1 can be selected from nSTOP0, nSTOP1 and limit signals. Step 2 can be selected from either nSTOP1 or limit signals. Step 3 is fixed to nSTOP2 signal. The same signal can be set to Step 1 and Step 2.

The detection signal specification in Step 1 and Step 2 is shown in the table below.

Table 2.5-5 Detection Signal Specification in Step 1 and Step 2

Step 1			Step 2	
D3 bit S1G1	D2 bit S1G0	Detection signal	D6 bit S2SG	Detection signal
0	0	nSTOP0	0	nSTOP1
0	1	nSTOP1	1	Limit signal
1	0	Limit signal		
1	1	—		

If a limit signal is specified as a detection signal, the limit signal in the search direction specified by D1 bit (S1DR) in Step 1 or D5 bit (S2DR) in Step 2 are selected. If the search direction is + direction, it becomes nLMTP signal and If – direction, it becomes nLMTM signal.

The logical level of an input signal that is detected must be set with Hi active or Low active by WR2 register. For more details of the WR2 register, see chapter 6.6.

④ Deviation counter clear output and real/logical position counter clear setting

In Step2 and Step3, when a specified detection signal rises from inactive to active, the user can specify whether to output the deviation counter clear signal (nDCC) or not. 0: Non- output, 1: Output

And at the end of Step 2, 3 and 4, the user can clear real/logical position counter. 0: Non- clear, 1: Clear

The specified bits for deviation counter clear signal (nDCC) output and real/logical position counter clear in each step are shown in the table below.

Table 2.5-6 nDCC Output and Real/Logical Position Counter Clear Specified Bit in Each Step

	Step 1	Step 2	Step 3	Step 4	
Deviation counter clear signal (nDCC) output	—	D7 bit S2DC	D12 bit S3DC	—	0: Non- output 1: Output
Real position counter clear	—	D8 bit S2RC	D13 bit S3RC	(※1)	0: Non- clear 1: Clear
Logical position counter clear	—	D9 bit S2LC	D14 bit S2LC	(※1)	

(※1) Real/logical position counter clear at the end of Step 4 (when Step 4 is executed), use the setting of automatic home search mode setting 2 (24h) for whether or not to clear at the end of an automatic home search. See “■Automatic home search mode setting 2” described as follows.

■ Automatic home search mode setting 2

Automatic home search mode setting 2 can be set by setting each bit of WR6 register as shown below and then writing automatic home search mode setting 2 command (24h) into WR0 register. It specifies the logical level of deviation counter clear (nDCC) output pulses and pulse width, enable/disable the timer between steps and timer time, real/logical position counter clear at the end of an automatic home search, AND stop condition for the encoder Z-phase signal (nSTOP2) and home signal (nSTOP1).

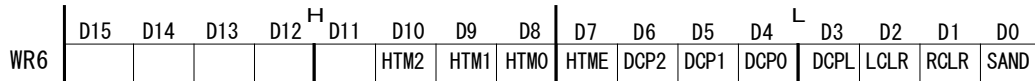

① The logical level of deviation counter clear (nDCC) output pulse and pulse width

For when deviation counter clear signal (nDCC) is output in each step, the user can specify the logical level and pulse width. To specify the logical level, set 0: Hi pulse or 1: Low pulse to D3 bit (DCPL).

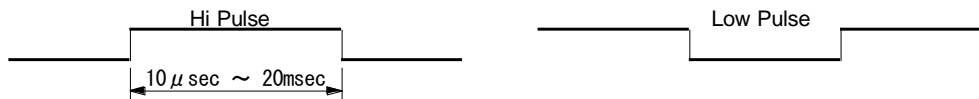

Fig. 2.5-12 The Logical Level of Deviation Counter Clear Output Pulse

Use 3bits, D6~4 (DCP2~DCP0) to set the pulse width. The settable pulse width is shown in the table below.

Table 2.5-7 The Pulse Width of Deviation Counter Clear Output

WR6/D6 DCP2	WR6/D5 DCP1	WR6/D4 DCP0	Pulse Width (CLK=16MHz)
0	0	0	10 μsec
0	0	1	20 μsec
0	1	0	100 μsec
0	1	1	200 μsec
1	0	0	1 msec
1	0	1	2 msec
1	1	0	10 msec
1	1	1	20 msec

② Enable/disable the timer between steps

The user can set to enable/disable the timer between steps and timer time.

To enable/disable the timer between steps, set 0: Disable or 1: Enable to D7 bit (HTME).

Timer time can be set by D10~7 bits (HTM2~HTM0), and the interval of the timer between steps is shown in the table below.

Table 2.5-8 The Interval of the Timer between Steps

WR6/D10 HTM2	WR6/D9 HTM1	WR6/D8 HTM0	Timer Time (CLK=16MHz)
0	0	0	1 msec
0	0	1	2 msec
0	1	0	10 msec
0	1	1	20 msec
1	0	0	100 msec
1	0	1	200 msec
1	1	0	500 msec
1	1	1	1000 msec

③ Real/logical position counter clear at the end of automatic home search

At the end of an automatic home search, real/logical position counter clear can be set.

To clear the real position counter, set 0: Non-clear or 1: Clear to D1 bit (RCLR).

To clear the logical position counter, set 0: Non-clear or 1: Clear to D2 bit (LCLR).

④ AND stop condition for encoder Z-phase signal (nSTOP2) and home signal (nSTOP1)

This is the function to stop driving when a home signal (nSTOP1) is active and an encoder Z-phase signal (nSTOP2) changes to active in Step 3. Set 1 to D0 bit (SAND), and driving will stop when a home signal (nSTOP1) is active and an encoder Z-phase signal (nSTOP2) changes to active.

[Note]

- Use this function only when nSTOP1 is selected as the detection signal in Step 2. When a limit signal is selected as the detection signal in Step 2, set as 0, or the operation does not work correctly.

2.5.5 Execution of Automatic Home Search and the Status

■ Execution of automatic home search

An automatic home search is executed by automatic home search execution command (5Ah). It will be started by writing the command code 5Ah to WR0 register after correctly setting the automatic home search mode and speed parameter.

■ Suspension of automatic home search

In order to suspend automatic home search operation, write decelerating stop command (56h) or instant stop command (57h). The step currently being executed is suspended and the automatic home search is terminated.

When the timer between steps is enabled and stop command is written during the timer operation, the timer is also suspended and the automatic home search is terminated.

■ Status register

D3~0 bits (n-DRV) of the main status register RR0 indicate driving is in execution. The bits also indicate the automatic home search is in execution. When an automatic home search starts, the bit of execution axis is set as 1 and the state is maintained from the start of Step 1 operation to the end of Step 4 operation. At the termination of Step 4, the bit is reset to 0.

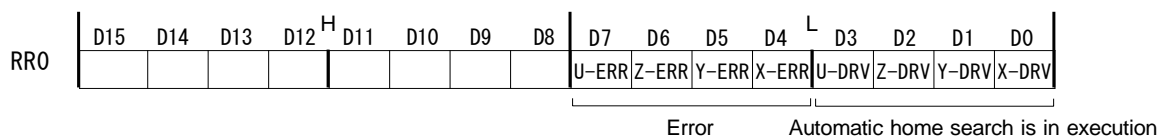

If an error occurs during the execution of automatic home search, D7~4 bits (n-ERR) of execution axis in RR0 register becomes 1. The error factor will be displayed in D6~D0 bits of RR2 register as shown below.

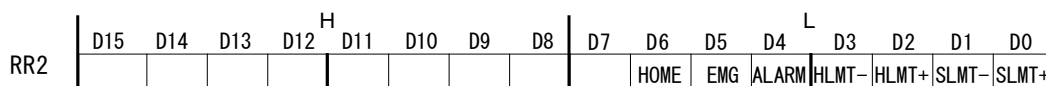

For more details of each error factor, see chapter 6.13.

D14~D9 bits (HSST5~0) of RR3 register Page0 indicate the automatic home search execution state by number. The user can check the operation currently being executed.

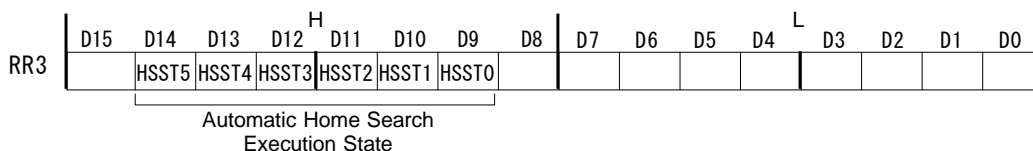

Table 2.5-9 Automatic Home Search Execution Status

Execution state	Execution step	Operation details
0		Waits for automatic home search execution command
3	Step 1	Waits for activation of a detection signal in the specified search direction
6		The timer is running between Step 1 and Step 2.
1 1	Step 2	Waits for activation of a detection signal in the direction opposite to the specified search direction (irregular operation)
1 5		Waits for deactivation of a detection signal in the direction opposite to the specified search direction (irregular operation)
1 8		The timer is running after irregular operation
2 0		Waits for activation of a detection signal in the specified search direction
2 3		The timer is running between Step 2 and Step 3, or deviation counter clear is outputting
2 8	Step 3	Waits for activation of nSTOP2 signal in the specified search direction
3 2		The timer is running between Step 3 and Step 4, or deviation counter clear is outputting.
3 6	Step 4	Offset driving in the specified search direction

2.5.6 Errors Occurring at Automatic Home Search

The following table lists the errors that may occur during the execution of an automatic home search.

Table 2.5-10 Errors Occurring at Automatic Home Search

Cause of the error	Operation of IC at the error	Display at termination
The nALARM signal was activated in any of the Steps 1 to 4	The search driving stops instantly without executing the following steps.	RR0/D7~4(execution axis) : 1, RR2/D4 : 1
The EMGN signal was activated in any of the Steps 1 to 4	The search driving stops instantly without executing the following steps.	RR0/ D7~4(execution axis) : 1, RR2/D5 : 1
The limit signal in the moving direction (nLMTP/M) is activated in Step 3 (Note)	The search driving stops instantly / by deceleration without executing the following steps.	RR0/D7~4(execution axis) : 1, RR2/D3 or D2 : 1
The limit signal in the moving direction (nLMTP/M) is activated in Step 4 (Note)	The offset action stops instantly / by deceleration and the operation stops.	RR0/D7~4(execution axis) : 1,
The nSTOP2 signal is already active at the start of Step 3	Operation stops without executing the following steps.	RR0/D7~4(execution axis) : 1, RR2/D6 : 1

Make sure to check the D7~4 bits (n-ERR) of RR0 register after the termination of an automatic home search. If the error bit of execution axis is 1, the automatic home search is not performed correctly.

[Note]

- In Steps 1 and 2, when the limit signal in the moving direction becomes active, search driving stops instantly / by deceleration, however the error does not occur.

■ Symptom at sensor failure

It describes the symptoms when a failure occurs regularly in the sensor circuit such as a home search signal or a limit signal. However, analysis of intermittent failures caused by noise around the cable path, loose cable, or unstable operation of the device is difficult and such failures are not applicable to these cases described below. These symptoms may occur due to a logical setting error or signal wiring error at the development of a customer system.

Table 2.5-11 Symptom at Sensor Failure

Failure cause		Symptom
Failure in the device of the limit sensor and wiring path	Kept ON	The axis does not advance to the direction and the limit error bit (RR2/D3 or D2) is set as 1 at the termination.
	Kept OFF	The axis runs into the mechanical terminal point and the home search operation does not terminate.
Failure in the device of the Step1 detection signal (nSTOP0,1) sensor and wiring path	Kept ON	Although Step 1 is enabled and automatic home search is started from the signal OFF position, the axis advances to Step 2 without executing Step 1 (high-speed home search).
	Kept OFF	Operation stops in Step 1 (high-speed home search) by setting the limit and proceeds with irregular operation of Step 2. The home search result is correct, however, the operation is not normal.
Failure in the device of the Step2 detection signal (with nSTOP1) sensor and wiring path	Kept ON	The axis moves in the opposite direction in Step 2 (low-speed home search) and stops by setting the limit. At the termination, the error bit (RR2/D3 or D2) of the limit in the opposite direction is set as 1.
	Kept OFF	The axis moves in the opposite direction after setting the limit in the specified direction in Step 2 (low-speed home search) and terminates by setting the limit in the opposite direction. At the termination, the error limit (RR2/D3 or D2) of the limit in the opposite direction is set as 1.
Failure in the device of the Z-phase (nSTOP2) sensor and wiring path	Kept ON	Operation stops due to an error in Step 3 (low-speed Z-phase search). RR2/D6 is set as 1.
	Kept OFF	Operation stops in Step 3 (low-speed Z-phase search) by setting the limit in the specified direction. The error bit of the limit in the specified direction (RR2/D3 or D2) is set as 1 at the termination.

2.5.7 Notes on Automatic Home Search

■ Search speed

A home search speed (HV) must be set at a low speed to increase the home search position precision. Set a value lower than the initial speed to stop the operation immediately when an input signal becomes active.

For the encoder Z-phase search of Step 3, the relationship between the Z-phase signal delay and the home search speed (HV) becomes important. For instance, if a total of the photo coupler delay time of the Z-phase signal path and delay time of the integral filter incorporated in the IC is the maximum 500 μ sec, the home search speed must be set so that the encoder Z-phase output is ON for more than 1msec.

■ Step 3 (Z-phase search) starting position

In the Z-phase search of Step 3, the function stops search driving when the Z-phase signal (nSTOP2) changes from inactive to active. Therefore, the Step 3 starting position (that is, Step 2 stop position) must be stable and different from this change point. Normally, adjust mechanically so that the Step 3 starting position becomes the 180° opposite side to the encoder Z-phase position.

■ Software limit

Disable the software limit during the execution of automatic home search. If software limit is enabled, the automatic home search is not performed correctly. After the automatic home search is finished correctly, set a software limit after setting the real / logical position counter.

■ Logical setting of each input signal

Use the bits (WR2/D0,D2,D4) of WR2 register for the active logical setting of the input signal (nSTOP0,1,2) that is used by an automatic home search. In an automatic home search, the settings in the bits (WR2/D1,D3,D5) that enable/disable each signal are ignored.

2.5.8 Examples of Automatic Home Search

Example 1 Home search using a home signal

High-speed and low-speed search is performed by one home signal, and encoder Z-phase search is not performed. Make sure to input a home signal to nSTOP1.

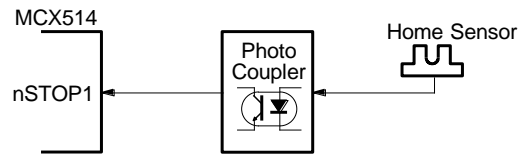

Fig. 2.5-13 Connection of Example 1 Automatic Home Search

The operation steps of an automatic home search are shown in the table below.

Table 2.5-12 Automatic Home Search Example 1 Operation

Step	Operation	Execution/ Non- execution	Detection signal	Signal level	Search direction	Search speed
1	High-speed search	Execution	nSTOP1	Low active	- direction	20,000pps
2	Low -speed search	Execution			- direction	500pps
3	Z-phase search	Non- execution	-	-	-	-
4	Offset drive	Execution	-	-	+ direction	20,000pps

In Step 1, a home search is performed at a high-speed of 20,000pps in the - direction until nSTOP1 signal detects Low level, and if it detects Low level (active), operation stops by deceleration.

In Step 2, if nSTOP1 signal is Low level (active), it drives at a low-speed of 500pps in the direction opposite to a specified direction (in this case + direction) by irregular operation ①, and then if nSTOP1 signal becomes Hi level (that is it escapes nSTOP1 active section), operation stops. After that it drives at a low-speed of 500pps in the direction specified by Step 2 and if nSTOP1 signal becomes Low level again, operation stops.

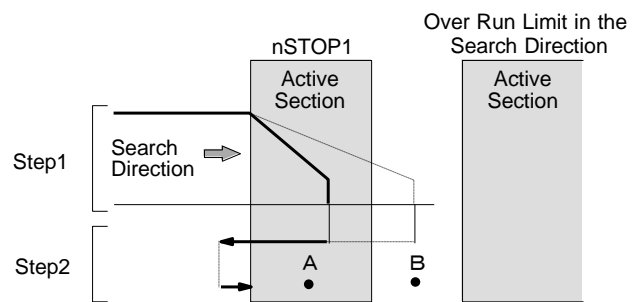

Fig. 2.5-14 Operation of Example 1 Automatic Home Search

In Step 1, in the case when it passes through nSTOP1 active section and then stops by deceleration, as the dash line shown in the figure above, it returns in the opposite direction once and escapes nSTOP1 active section, then search operation is performed in the specified direction by Step 2. This operation is applied to only when a detection signal and search direction is the same in Step 1 and Step 2.

When the automatic home search starting position is in point A as shown in the figure above, the function performs irregular operation ① of Step 2 without executing Step 1. When the starting position is in point B, the function performs irregular operation ② of Step 2 after setting the limit in the search direction in Step 1. For more details of the irregular operation ②, see chapter 2.5.1.

In this example, suppose that a home search is performed without an encoder such as a stepping motor, and Z-phase search is not performed in Step 3. In Step 4, offset driving is performed to the operation home position up to 3500 pulses in the + direction.

【Program Example in X axis】

```

// WR2 Register setting
WR0 ← 011Fh Write // Select X axis
WR2 ← 0800h Write // Home signal logical setting: XSTOP1: Low active
// Enables hardware limit

// Input signal filter mode setting
WR6 ← 0A0Fh Write // D11~D8 1010 Filter delay: 512μsec
// D2 1 XSTOP1 signal: Enables the filter
WR0 ← 0125h Write // Writes a command

// Automatic home search mode setting 1
WR6 ← 8037h Write // D15 1 Step 4 execution/non-execution: Execution
// D14 0 Step 3 LP clear Disable
// D13 0 Step 3 RP clear Disable
// D12 0 Step 3 DCC output: Disable
// D11 0 Step 3 search direction: -
// D10 0 Step 3 execution/non-execution: Non-execution
// D9 0 Step 2 LP clear Disable
// D8 0 Step 2 RP clear Disable
// D7 0 Step 2 DCC output: Disable
// D6 0 Step 2 detection signal: STOP1
// D5 1 Step 2 search direction: -direction
// D4 1 Step 2 execution/non-execution: Execution
// D3,2 0,1 Step 1 detection signal: STOP1
// D1 1 Step 1 search direction: -direction
// D0 1 Step 1 execution/non-execution: Execution
WR0 ← 0123h Write // Writes a command

// Automatic home search mode setting 2
WR6 ← 0000h Write // D15 0
// D14 0
// D13 0
// D12 0
// D11 0
// D10~8 0 Timer value
// D7 0 Timer between steps Disable
// D6~4 0 DCC pulse width
// D3 0 DCC pulse logic
// D2 0 At the termination of home search, LP clear Disable
// D1 0 At the termination of home search, RP clear Disable
// D0 0 Step 2 & 3 Disable
WR0 ← 0124h Write // Writes a command

// High-speed home search and low-speed home search setting
WR6 ← 7318h Write // Acceleration/deceleration : 95,000 PPS/SEC
WR7 ← 0001h Write
WR0 ← 0102h Write

WR6 ← 03E8h Write // Initial speed : 1000 PPS
WR7 ← 0000h Write
WR0 ← 0104h Write

WR6 ← 4E20h Write // Speed of step 1 and 4 : 20000 PPS
WR7 ← 0000h Write
WR0 ← 0105h Write

WR6 ← 01F4h Write // Speed of step 2 : 500 PPS
WR7 ← 0000h Write
WR0 ← 0114h Write

// Offset pulse setting
WR6 ← 0DACH Write // Offset driving pulse count : 3500
WR7 ← 0000h Write
WR0 ← 0106h Write

// Starts execution of automatic home search
WR0 ← 015Ah Write

```

■ Example 2 Home search using a limit signal

The example that uses a limit signal of one side as an alternative home signal and performs a home search. In this case, a limit signal in the - direction is used as an alternative home signal. To perform a home search by using a limit signal, the following two conditions are applied.

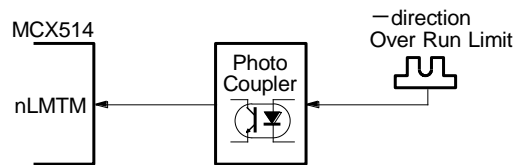

Fig. 2.5-15 Connection of Example 2 Automatic Home Search

- a. When high-speed search operation in Step 1 is performed, decelerating stop must be done sufficiently within the distance from the limit signal activation position to the mechanical limit position.
- b. The automatic home search position is not beyond the limit signal active section in the search direction (B in Fig. 2.5-16).

The operation steps of an automatic home search in this case are shown in the table below. The mode setting in Steps 1 and 2, when a search direction is specified in the -direction and a limit signal is specified as a detection signal, the limit signal of the -direction is determined (nLMTM).

Table 2.5-13 Automatic Home Search Example 2 Operation

Step	Operation	Execution/ Non- execution	Detection signal	Signal level	Search direction	Search speed
1	High-speed search	Execution	nLMTM	Low active	-direction	20,000pps
2	Low -speed search	Execution			-direction	500pps
3	Z-phase search	Non- execution	-	-	-	-
4	Offset drive	Execution	-	-	+ direction	20,000pps

The operation from Step 1 to Step 4 is the same as the operation using a home signal (nSTOP1) described above.

When the automatic home search starting position is in point A as shown in the right side figure, the function performs irregular operation ① of Step 2 without executing Step 1. And it escapes in the reverse direction from the limit signal active section once, and then search operation is performed in the specified direction.

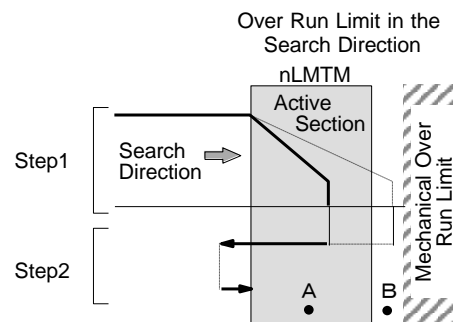

Fig. 2.5-16 Operation of Example 2 Automatic Home Search

【Program Example in X axis】

```

// WR2 Register setting
WR0 ← 011Fh Write // Select X axis
WR2 ← 1800h Write // Limit signal logical setting : XLMTM:Low active
// Enables hardware limit Decelerating stop Note1

// Input signal filter mode setting
WR6 ← 0A0Fh Write // D11~D8 1010 Filter delay:512μsec
// D1 1 XLMTM signal : Enables the filter
WR0 ← 0125h Write // Writes a command

// Automatic home search mode setting 1
WR6 ← 807Bh Write // D15 1 Step 4 execution/non-execution : Execution
// D14 0 Step 3 LP clear Disable
// D13 0 Step 3 RP clear Disable
// D12 0 Step 3 DCC output : Disable
// D11 0 Step 3 search direction : -
// D10 0 Step 3 execution/non-execution : Non-execution
// D9 0 Step 2 LP clear Disable
// D8 0 Step 2 RP clear Disable
// D7 0 Step 2 DCC output : Disable
// D6 1 Step 2 detection signal : LMTM
// D5 1 Step 2 search direction : -direction
// D4 1 Step 2 execution/non-execution : Execution
// D3,2 1,0 Step 1 detection signal : LMTM
    
```

```

// D1      1 Step 1 search direction :           -direction
// D0      1 Step 1 execution/non-execution :   Execution
WRO ← 0123h Write // Writes a command

// Automatic home search mode setting 2
WR6 ← 0000h Write // D15      0
// D14     0
// D13     0
// D12     0
// D11     0
// D10~8   0 Timer value
// D7      0 Timer between steps                 Disable
// D6~4    0 DCC pulse width
// D3      0 DCC pulse logic
// D2      0 At the termination of home search, LP clear   Disable
// D1      0 At the termination of home search, RP clear   Disable
// D0      0 Step 2 & 3                               Disable
WRO ← 0124h Write // Writes a command

// High-speed home search and low-speed home search setting
WR6 ← 7318h Write // Acceleration/deceleration : 95,000 PPS/SEC
WR7 ← 0001h Write
WRO ← 0102h Write

WR6 ← 03E8h Write // Initial speed : 1000 PPS
WR7 ← 0000h Write
WRO ← 0104h Write

WR6 ← 4E20h Write // Speed of step 1 and 4 : 20000 PPS
WR7 ← 0000h Write
WRO ← 0105h Write

WR6 ← 01F4h Write // Speed of step 2 : 500 PPS
WR7 ← 0000h Write
WRO ← 0114h Write

// Offset pulse setting
WR6 ← 0DACH Write // Offset driving pulse count : 3500
WR7 ← 0000h Write
WRO ← 0106h Write

// Starts execution of automatic home search
WRO ← 015Ah Write

```

Note1: The bits in WR2 register, D10 bit is to set the logical setting of a limit signal, D11 bit is to enable a limit function and D12 bit is to set a limit operation. However in this case, when a limit signal is used as a detection signal, the limit signal will be enabled regardless of D11 setting in the operation of that step (D11 setting does not affect the operation of steps using a limit signal as a detection signal). D12 bit must be enabled decelerating stop and about D10 bit, set it according to the usage.

[Notes on using limit signals]

- The same search direction must be applied for Steps 1 and 2. For Step 3 (Z-phase search), apply a direction opposite to the direction of Steps 1 and 2. For Step 4 also (offset driving), apply a direction opposite to Steps 1 and 2 and make sure that automatic home search operation stops at the position beyond the limit active section.

■ Example 3 Home search for a servo motor

In the case of the pulse input type servo driver, normally an encoder Z-phase signal is output from the driver (a servo amplifier). To perform the home search with high position precision, a deviation counter in the driver must be cleared in the output timing of the encoder Z-phase and a deviation counter clear signal must be input. The example of the home search connecting these signals is shown below.

As shown in the figure below, the home signal (nSTOP1) is input through the interface circuit from the home sensor. The encoder Z-phase input (nSTOP2) and the deviation counter clear output (nDCC) are connected to the servo driver through the interface circuit.

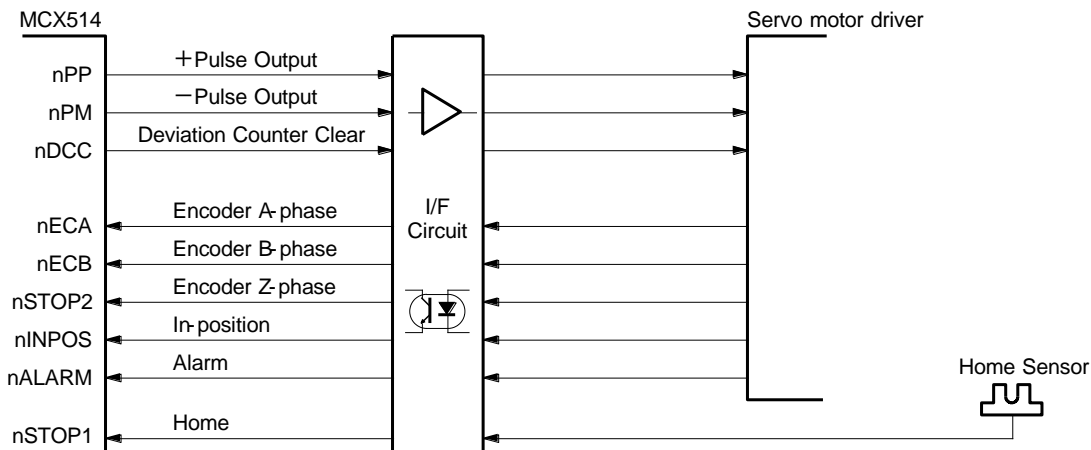

Fig. 2.5-17 Connection of Example 3 Automatic Home Search

[Note]

- The encoder Z-phase input must be connected to nSTOP2 of the IC. The line receiver or the high speed photo coupler is appropriate to the interface circuit for a rapid response.

Table 2.5-14 Automatic Home Search Example 3 Operation

Step	Operation	Execution/ Non- execution	Detection signal	Signal level	Search direction	Search speed
1	High-speed search	Execution	nSTOP1	Low active	- direction	20,000pps
2	Low -speed search	Execution			- direction	500pps
3	Z-phase search	Execution	nSTOP2	Low	- direction	500pps
4	Offset drive	Execution	-	-	+ direction	20,000pps

The operation from Step 1 to Step 2 is the same as the operation using a home signal (nSTOP1) described above.

When nSTOP1 input becomes Low in Step 2, Step 2 ends and it proceeds with Step 3. In Step 3, a home search is performed at a speed of 500pps in the - direction until nSTOP2 (Z-phase) signal detects Low level, and if it detects Low level, operation stops instantly. nDCC (deviation counter clear) is output by the ↓ of nSTOP2 input signal. In this case, nDCC signal is set to output Hi pulses of 100 μ sec.

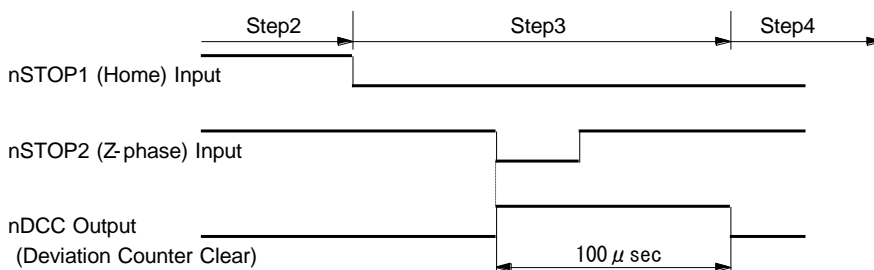

Fig. 2.5-18 Operation of Example 3 Automatic Home Search

In addition, when the nSTOP2 (Z-phase) signal becomes Low active in Step 3, the real position counter and logical position counter should be set to clear them.

【Program Example in X axis】

```

// WR2 Register setting
WRO ← 011Fh Write // Select X axis
WR2 ← 0800h Write // Home signal logical setting : XSTOP1,2:Low active
// Enables hardware limit

// Input signal filter mode setting
WR6 ← 0ACFh Write // D15~D12 0000 Filter FE6,7 delay:500nsec
// D11~D8 1010 Filter FE0-5 delay:512μsec
// D6 1 XSTOP2 signal : Enables the filter
// D2 1 XSTOP1 signal : Enables the filter
WRO ← 0125h Write // Writes a command

// Automatic home search mode setting 1
WR6 ← FC37h Write // D15 1 Step 4 execution/non-execution : Execution
// D14 1 Step 3 LP clear Enable
// D13 1 Step 3 RP clear Enable
// D12 1 Step 3 DCC output : Enable
// D11 1 Step 3 search direction : -direction
// D10 1 Step 3 execution/non-execution : Execution
// D9 0 Step 2 LP clear Disable
// D8 0 Step 2 RP clear Disable
// D7 0 Step 2 DCC output : Disable
// D6 0 Step 2 detection signal : STOP1
// D5 1 Step 2 search direction : -direction
// D4 1 Step 2 execution/non-execution : Execution
// D3,2 0,1 Step 1 detection signal : STOP1
// D1 1 Step 1 search direction : -direction
// D0 1 Step 1 execution/non-execution : Execution
WRO ← 0123h Write // Writes a command

// Automatic home search mode setting 2
WR6 ← 0020h Write // D15 0
// D14 0
// D13 0
// D12 0
// D11 0
// D10~8 0 Timer value
// D7 0 Timer between steps Disable
// D6~4 010 DCC pulse width 100μsec
// D3 0 DCC pulse logic Hi pulse
// D2 0 At the termination of home search, LP clear Disable
// D1 0 At the termination of home search, RR clear Disable
// D0 0 Step 2 & 3 Disable
WRO ← 0124h Write // Writes a command

// High-speed home search and low-speed home search setting
WR6 ← 7318h Write // Acceleration/deceleration : 95,000 PPS/SEC
WR7 ← 0001h Write
WRO ← 0102h Write

WR6 ← 03E8h Write // Initial speed : 1000 PPS
WR7 ← 0000h Write
WRO ← 0104h Write

WR6 ← 4E20h Write // Speed of step 1 and 4 : 20000 PPS
WR7 ← 0000h Write
WRO ← 0105h Write

WR6 ← 01F4h Write // Speed of step 2, 3 : 500 PPS
WR7 ← 0000h Write
WRO ← 0114h Write

// Offset pulse setting
WR6 ← 0DACH Write // Offset driving pulse count : 3500
WR7 ← 0000h Write
WRO ← 0106h Write

// Starts execution of automatic home search
WRO ← 015Ah Write

```

2.6 Synchronous Action

Synchronous action of this IC performs various actions in each axis, among axes or between the IC and an external device during the driving, such as output an external signal at a specified position or save the current position to a specified register by the external signal. For instance, the following actions can be performed.

Example 1 Outputs a signal to the external when passing through a specified position during the driving.

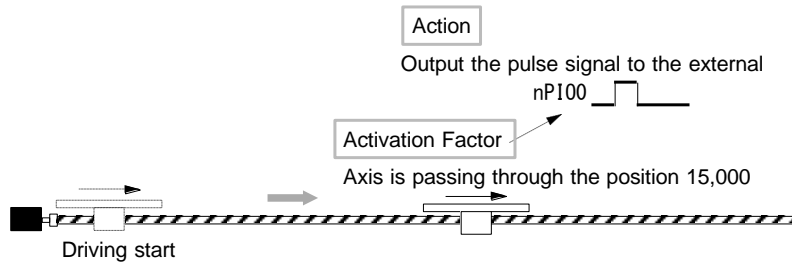

Fig. 2.6-1 Example 1 of Synchronous Action

Example 2 Saves the current position to a specified register when an external signal is input during the driving.

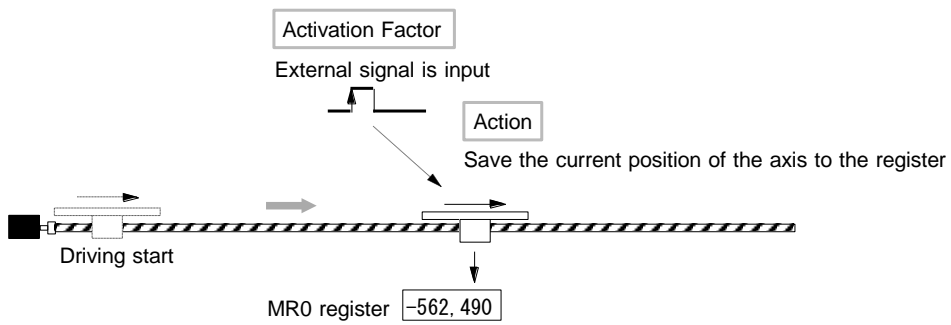

Fig. 2.6-2 Example 2 of Synchronous Action

Example 3 Outputs N split pulses from a specified position to the external during the driving.

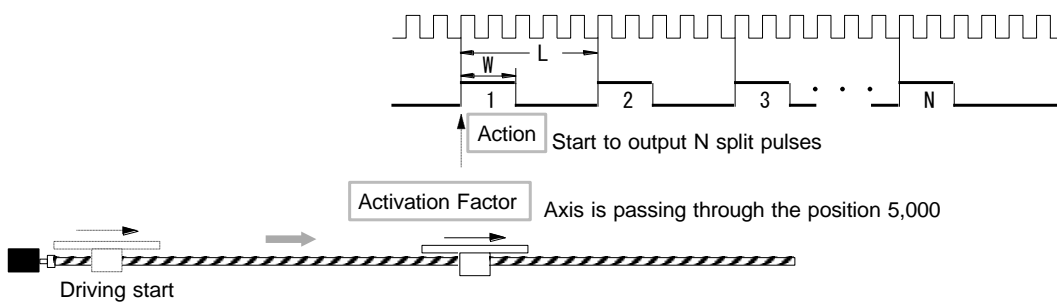

Fig. 2.6-3 Example 3 of Synchronous Action

Example 4 Measures the time to pass through from the position A to the position B during the driving.

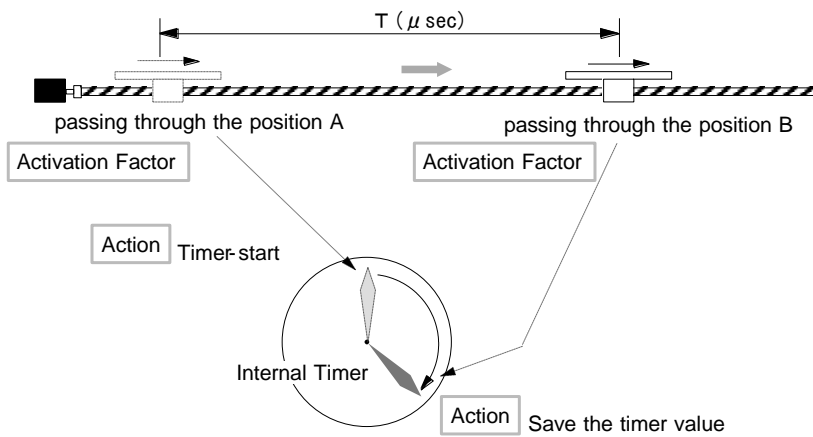

Fig. 2.6-4 Example 4 of Synchronous Action

Normally, such synchronous actions can be performed by coding a program on the CPU side. However, this function is useful when no delay caused by CPU interrupt handling or program execution time is allowed. The synchronous action of this IC is a function that executes a specified action immediately when a specified activation factor occurs. This linked action is performed without CPU intervention, achieving high-precision synchronous control.

One synchronous action set means that performs a specified action when a specified activation factor occurs. MCX514 has independent 4 synchronous action sets in each axis. It can perform 4 synchronous action sets independently, in addition can perform them in cooperation among axes.

Each synchronous action set SYNC0~3 has 15 types of activation factors in each axis, the user selects one and configures it by the code. And about actions that are activated, 24 types of actions are provided.

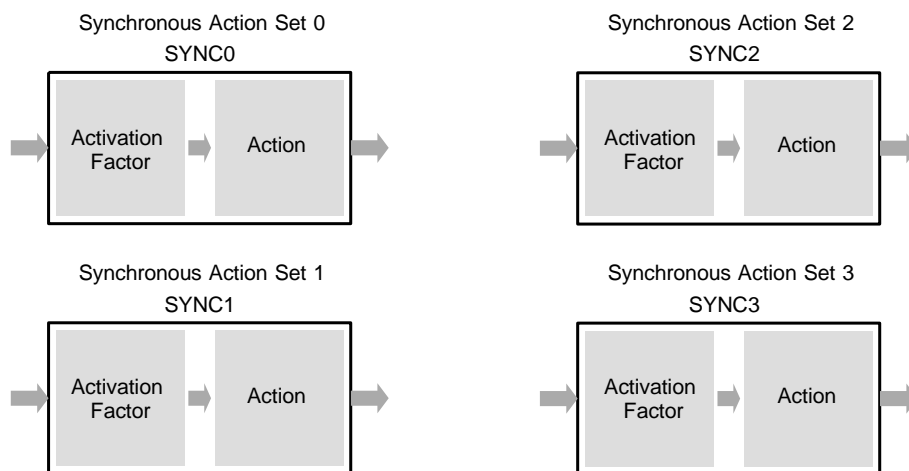

Fig. 2.6-5 Synchronous Action Set

2.6.1 Activation Factor

16 activation factors are provided for synchronous actions as shown in the table below.

Table 2.6-1 Activation Factors

Code (Hex)	Synchronous action set 0 SYNC0	Synchronous action set 1 SYNC1	Synchronous action set 2 SYNC2	Synchronous action set 3 SYNC3	Description
1	MR0 object changed to True	MR1 object changed to True	MR2 object changed to True	MR3 object changed to True	1
2	The internal timer is up				2
3	Start of driving				3
4	Start of driving at constant speed area in acceleration / deceleration driving				3
5	Termination of driving at constant speed area in acceleration / deceleration driving				3
6	Termination of driving				3
7	Start of split pulse				4
8	Termination of split pulse				4
9	Output of split pulse				4
A	nPIO0 input signal ↑	nPIO1 input signal ↑	nPIO2 input signal ↑	nPIO3 input signal ↑	5
B	nPIO0 input signal ↓	nPIO1 input signal ↓	nPIO2 input signal ↓	nPIO3 input signal ↓	6
C	nPIO4 input Low and nPIO0 input ↑	nPIO5 input Low and nPIO1 input ↑	nPIO6 input Low and nPIO2 input ↑	nPIO7 input Low and nPIO3 input ↑	7
D	nPIO4 input Hi and nPIO0 input ↑	nPIO5 input Hi and nPIO1 input ↑	nPIO6 input Hi and nPIO2 input ↑	nPIO7 input Hi and nPIO3 input ↑	8
E	nPIO4 input Low and nPIO0 input ↓	nPIO5 input Low and nPIO1 input ↓	nPIO6 input Low and nPIO2 input ↓	nPIO7 input Low and nPIO3 input ↓	9
F	nPIO4 input Hi and nPIO0 input ↓	nPIO5 input Hi and nPIO1 input ↓	nPIO6 input Hi and nPIO2 input ↓	nPIO7 input Hi and nPIO3 input ↓	10
0	NOP				11

Description 1: MRm object changed to True

It is activated when the comparative object of a multi-purpose register (MRm register) meets the comparison condition. As shown in the table, the MRm register corresponding to 4 synchronous action sets is fixed. The comparative object and comparison condition can be set by multi-purpose register mode setting command (20h). For instance, when the comparative object of MR0 register is set as the logical position counter (LP) and comparison condition is set as “comparative object ≥ MRm”, if the value of the logical position counter is equal to or larger than MR0 value, it will be activated. If comparison condition is already True when the synchronous action is enabled, the synchronous action is not activated at that time. After it returns to False, and then if it again changes to True, the synchronous action will be activated.

Description 2: The internal timer is up

It is activated when the internal timer is up. The timer value can be set by timer value setting command (16h). The timer can be started by timer-start command (73h) or the other synchronous action sets.

Description 3: Change of driving state

As shown below, it is activated when the change of a driving state occurs during the driving.

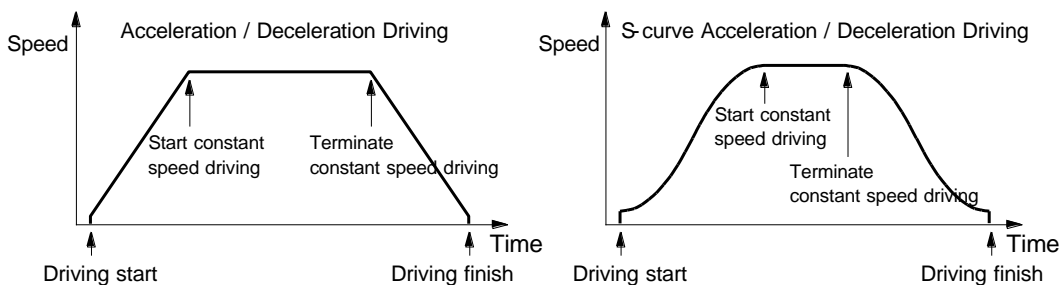

Fig. 2.6-6 Activation Factor regarding Driving State

[Note]

- The constant speed area (the area that driving is performed at a constant speed) may be slightly generated at the termination of driving in acceleration / deceleration driving.

Description 4: Split pulse

About “Start of split pulse”, a synchronous action is activated when split pulse is started by start of split pulse command (75h) or the other synchronous action sets.

About “Termination of split pulse”, a synchronous action is activated when output of the last split pulse is finished.

About “Output of split pulse”, a synchronous action is activated when split pulse is output (when rising or falling to the valid level). If a synchronous action is set to repeat, it is activated every split pulse.

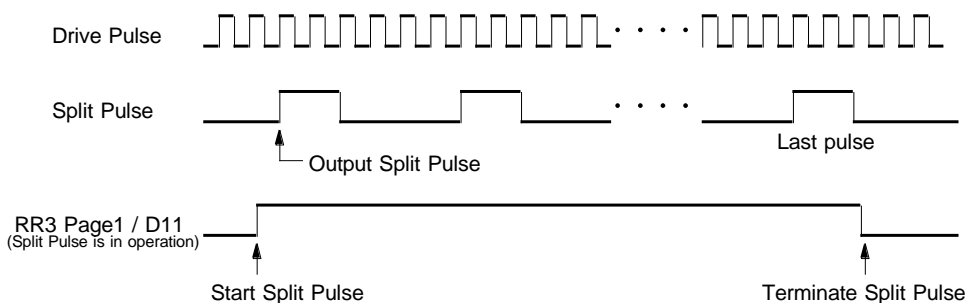

Fig. 2.6-7 Activation Factor of Split Pulse

Description 5: The change of when general purpose input signal is rising

About “nPIOm input signal ↑”, it is activated when nPIOm (m =0~3) input signal is rising from Low level to Hi level.

As shown in the table, the nPIOm signal corresponding to 4 synchronous action sets is fixed.

If the input signal is already Hi level when the synchronous action is enabled, the synchronous action is not activated at that time. After it falls to Low level, and then if it again rises to Hi level, the synchronous action will be activated.

Description 6: The change of when general purpose input signal is falling

About “nPIOm input signal ↓”, it is activated when nPIOm (m =0~3) input signal is falling from Hi level to Low level.

As shown in the table, the nPIOm signal corresponding to 4 synchronous action sets is fixed.

If the input signal is already Low level when the synchronous action is enabled, the synchronous action is not activated at that time. After it rises to Hi level, and then if it again falls to Low level, the synchronous action will be activated.

Description 7: General purpose input signal Low and the change of when rising

About “nPIOm input Low and nPIOk input ↑”, it is activated when nPIOm (m=4~7) input signal is Low level and nPIOk (k =0~3) input signal is rising from Low level to Hi level.

As shown in the table, the nPIOk, nPIOm signals corresponding to 4 synchronous action sets are fixed.

If nPIOm input signal is already Low level and nPIOk input signal is Hi level when the synchronous action is enabled, the behavior is the same as the description 5.

Description 8: General purpose input signal Hi and the change of when rising

About “nPIOm input Hi and nPIOk input ↑”, it is activated when nPIOm (m=4~7) input signal is Hi level and nPIOk (k =0~3) input signal is rising from Low level to Hi level.

As shown in the table, the nPIOk, nPIOm signals corresponding to 4 synchronous action sets are fixed.

If nPIOm input signal is already Hi level and nPIOk input signal is Hi level when the synchronous action is enabled, the behavior is the same as the description 5.

Description 9: General purpose input signal Low and the change of when falling

About “nPIOm input Low and nPIOk input ↓”, it is activated when nPIOm (m=4~7) input signal is Low level and nPIOk (k =0~3) input signal is falling from Hi level to Low level.

As shown in the table, the nPIOk, nPIOm signals corresponding to 4 synchronous action sets are fixed.

If nPIOm input signal is already Low level and nPIOk input signal is Low level when the synchronous action is enabled, the behavior is the same as the description 6.

Description 10: General purpose input signal Hi and the change of when falling

About “nPIOm input Hi and nPIOk input ↓”, it is activated when nPIOm (m=4~7) input signal is Hi level and nPIOk (k=0~3) input signal is falling from Hi level to Low level.

As shown in the table, the nPIOk, nPIOm signals corresponding to 4 synchronous action sets are fixed.

If nPIOm input signal is already Hi level and nPIOk input signal is Low level when the synchronous action is enabled, the behavior is the same as the description 6.

Description 11: NOP

It uses when the user does not set the condition of activation factor.

For instance, when the other SYNC activation is used in mode setting, the activation factor of a synchronous action set to be activated should be set as NOP.

2.6.2 Action

Activated actions are shown in the table below. Actions of code 01~09h, 0Fh, 10h are different depending on the synchronous action set 0 to 4.

Table 2.6-2 Actions

Code (Hex)	Synchronous action set 0 SYNC0	Synchronous action set 1 SYNC1	Synchronous action set 2 SYNC2	Synchronous action set 3 SYNC3	Description
01	MR0 → DV	MR1 → DV	MR2 → DV	MR3 → DV	1
02	MR0 → TP	MR1 → TP	MR2 → TP	MR3 → TP	1
03	MR0 → SP1	MR1 → SP1	MR2 → SP1	MR3 → SP1	1
04	MR0 → LP	MR1 → RP	MR2 → SV	MR3 → AC	1
05	LP → MR0	LP → MR1	LP → MR2	LP → MR3	2
06	RP → MR0	RP → MR1	RP → MR2	RP → MR3	2
07	CT → MR0	CT → MR1	CT → MR2	CT → MR3	2
08	CV → MR0	CA → MR1	—	—	2
09	nPIO0 signal pulse output	nPIO1 signal pulse output	nPIO2 signal pulse output	nPIO3 signal pulse output	3
0A	Start of relative position driving				
0B	Start of counter relative position driving				
0C	Start of absolute position driving				
0D	Start of +direction continuous pulse driving				
0E	Start of -direction continuous pulse driving				
0F	Start of relative position driving using MR0 value	Start of relative position driving using MR1 value	Start of relative position driving using MR2 value	Start of relative position driving using MR3 value	4
10	Start of absolute position driving using MR0 value	Start of absolute position driving using MR1 value	Start of absolute position driving using MR2 value	Start of absolute position driving using MR3 value	4
11	Decelerating stop				5
12	Instant stop				5
13	Drive speed increase				6
14	Drive speed decrease				6
15	Timer-start				
16	Timer-stop				
17	Start of split pulse				7
18	Termination of split pulse				7
00	NOP				8

Description 1: Load parameter value

It loads the value of a multi-purpose register MRm into each parameter.

Table 2.6-3 Load parameter value

Notation	Description
MRm → DV	Loads the value of MRm register into drive speed (DV).
MRm → TP	Loads the value of MRm register into drive pulse number (TP).
MRm → SP1	Loads the value of MRm register into split pulse data 1 (split length and pulse width).
MR0 → LP	Loads the value of MR0 register into logical position counter (LP).
MR1 → RP	Loads the value of MR1 register into real position counter (RP).
MR2 → SV	Loads the value of MR2 register into initial speed (SV).
MR3 → AC	Loads the value of MR3 register into acceleration (AC).

According to the number of synchronous action set, the MRm register that is used is fixed.

About action code 04h, the parameter that the value of MRm register is loaded changes according to the number of synchronous action set.

Description 2: Save parameter value

It saves each parameter value to a multi-purpose register MRm.

Table 2.6-4 Save parameter value

Notation	Description
LP → MRm	Saves the value of logical position counter (LP) to MRm register.
RP → MRm	Saves the value of real position counter (RP) to MRm register.
CT → MRm	Saves the current timer value to MRm register.
CV → MR0	Saves the current drive speed to MR0 register.
CA → MR1	Saves the current acceleration / deceleration value to MR1 register.

According to the number of synchronous action set, the MRm register that is used is fixed.

About action code 08h, the synchronous action set 1 and 2 can only be enabled, and the parameter for saving the value into MRm register is different.

Description 3: Synchronous pulse signal output

The pulse signal is output from nPIOm (m =0~3) signal.

The nPIOm signal corresponding to 4 synchronous action sets is fixed.

To perform this action, the following items must be set.

- ① nPIOm signal synchronous pulse output setting
- ② Logical level of output pulse signal and pulse width settings

To output the pulse signal for a synchronous action to the external, general purpose input/output signals must be set for the synchronous pulse output by mode setting. And this signal must be set the logical level of whether Hi or Low pulses are output and pulse width. These settings can be set by PIO signal setting 1 command (21h) or PIO signal setting 2 • Other settings (22h).

① nPIOm (m=0~3) signal synchronous pulse output setting

To set nPIOm signal for the synchronous pulse output by mode setting, use PIO signal setting 1 command (21h) and set as shown below.

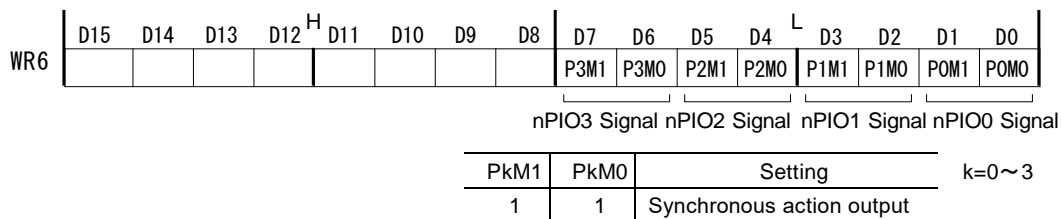

2 bits of WR6 register corresponding to the nPIOm signal that is used must be set as 1, 1 for the synchronous pulse output. For instance, when using XPIO2 signal, set D5, D4 bits (P2M1, P2M0) of WR6 register as 1, 1 and then write PIO signal setting 1 command (21h) with X axis into WR0 register.

② Logical level of output pulse signal and pulse width settings

To set the logical level of output pulse signal and pulse width, use PIO signal setting 2 • Other settings (22h) and set as shown below.

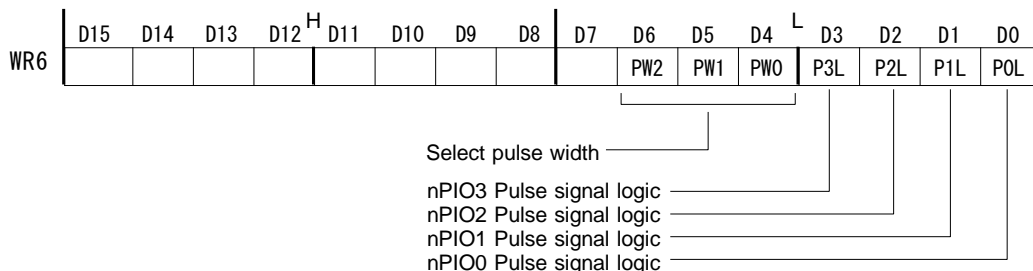

PkL (k=0~3)	Pulse signal logic
0	Outputs positive logic pulse
1	Outputs negative logic pulse

PW2	PW1	PW0	Pulse width (CLK=16MHz)
0	0	0	125nsec
0	0	1	312nsec
0	1	0	1µsec
0	1	1	4µsec
1	0	0	16µsec
1	0	1	64µsec
1	1	0	256µsec
1	1	1	1msec

Specify the logical level of nPIOm signal for D0 ~ D3 bits (P0L~P3L) of WR6 register. 0 outputs the positive logic pulse and 1 outputs the negative logic pulse. The bit corresponding to the unused signal should be set as either 0 or 1. And the pulse width shown above must be set to D4 to D6 bits (PW0~PW3) of WR6 register. The settings of WR6 register will be determined by writing PIO signal setting 2 • Other settings (22h) into WR0 register.

[Note]

- The setting of pulse width is common in nPIO0~nPIO3 all signals. It cannot be set each signal individually.
- If the synchronous pulse output is activated continuously, when the user tries to activate the next during the synchronous pulse output, the synchronous pulse does not become inactive and it will output a specified pulse width again from when the next is activated.

Description 4: Start of relative / absolute position driving using MRm value

At the start of driving, the value of MRm register is set as drive pulse number (TP) and relative or absolute position driving is started.

Since the value of MRm register is written in drive pulse number (TP), the setting of drive pulse number (TP) will be changed by execution of this action. The changed value of drive pulse number (TP) can be checked by drive pulse number / finish point setting value reading command (46h).

Description 5: Drive decelerating stop / Instant stop

It stops driving in deceleration or instantly.

[Note]

- When interpolation driving is stopped by this action, be sure to written error/finishing status clear command (79h) to the interpolation axis after checking that interpolation drive stops.

Description 6: Drive speed increase / decrease

It increases / decreases the current drive speed during the driving. The increase / decrease value must be set by speed increasing / decreasing value setting command (15h) in advance.

This action is invalid during the acceleration / deceleration of S-curve driving and interpolation driving.

Description 7: Start / termination of split pulse

“Start of split pulse” starts the split pulse with pre-set settings. The starting drive pulse of split pulse is determined by the timing of an activation factor occurrence. “Termination of split pulse” stops the split pulse in operation. The stop timing of split pulse is determined by the timing of an activation factor occurrence. For more details, see chapter 2.7.

Description 8: NOP

It uses when no action is needed even though the activation factor becomes active.

This is useful for when the user wants to generate an interrupt only by an activation factor.

2.6.3 Synchronous Action Settings

There are SYNCm settings, Enable setting and Disable setting for synchronous action settings, and by configuring these settings, a synchronous action is performed.

■ SYNCm Setting

It sets 4 synchronous action sets by synchronous action SYNCm setting command (26h, 27h, 28h, 29h), which sets the activation factor, actions, the activation of other synchronous action sets, the setting for whether the synchronous action is performed once or repeatedly.

Write the settings into WR6 register and then write synchronous action setting command.

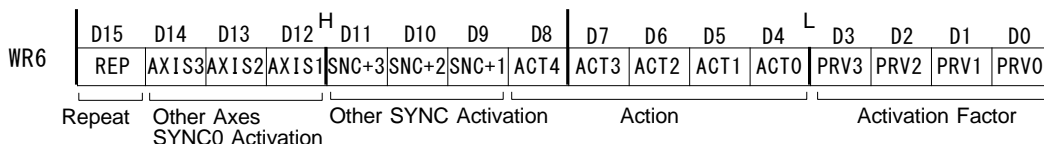

Activation factor setting

Specify the activation factor by 4 bits, D3~0 (PRV3~PRV0).

For instance, to set “Start of driving” as the activation factor, specify the code 3h, that is D3~0 is 0011.

For more details of the activation factor, see chapter 2.6.1.

Action setting

Specify the action by 5 bits, D8~4 (ACT4~ACT0).

For instance, to set “Start of split pulse” as the action, specify the code 17h, that is D8~4 is 10111.

For more details of the action, see chapter 2.6.2.

Activation of other synchronous action sets

This bit is used to activate simultaneously with the action of the other synchronous action set when the activation factor is activated by the synchronous action set.

Specify by D11~9 bits (SNC+3~SNC+1).

To activate the action of the other synchronous action set, specify 1 and not to activate, specify 0.

The specified bit and the activation of other synchronous action sets are shown in the table below.

Table 2.6-5 Activation of Other Synchronous Action Sets

Self- synchronous action set	D11(SNC+3)	D10(SNC+2)	D9(SNC+1)
SYNC0	SYNC3 activation	SYNC2 activation	SYNC1 activation
SYNC1	SYNC0 activation	SYNC3 activation	SYNC2 activation
SYNC2	SYNC1 activation	SYNC0 activation	SYNC3 activation
SYNC3	SYNC2 activation	SYNC1 activation	SYNC0 activation

This function allows to perform more complex synchronous actions because it can activate multi-actions simultaneously to one activation factor.

For example, suppose the self-synchronous action set is SYNC0, and if the user wants to activate the actions of SYNC1, 2 when the activation factor of SYNC0 is activated, set D9 and D10 bits as 1 based on the table above. By these settings, when the activation factor of SYNC0 is activated, the actions of SYNC1, 2 will be activated with the action of SYNC0. At this time, the activation factor of SYNC1, 2 must be set as NOP and only set the action. In addition, they must be enabled by synchronous action enable setting command.

Activation of other synchronous action sets in other axes

This bit is used to activate simultaneously in cooperation with the action of synchronous action set 0(SYNC0) in another axis when the activation factor is activated by the synchronous action set.

Specify by D14~12 bits (AXIS3~AXIS1).

To activate the action of synchronous action set 0(SYNC0) in another axis, specify 1 and not to activate, specify 0.

The specified bit and the activation of synchronous action set 0(SYNC0) in another axis are shown in the table below.

Table 2.6-6 Activation of Other Synchronous Action Sets in other axes

Self-axis	D14(AXIS3)	D13(AXIS2)	D12(AXIS1)
X	U axis SYNC0 activation	Z axis SYNC0 activation	Y axis SYNC0 activation
Y	X axis SYNC0 activation	U axis SYNC0 activation	Z axis SYNC0 activation
Z	Y axis SYNC0 activation	X axis SYNC0 activation	U axis SYNC0 activation
U	Z axis SYNC0 activation	Y axis SYNC0 activation	X axis SYNC0 activation

This function allows to perform more complex synchronous actions because it can activate multi-actions in other axes simultaneously to one activation factor.

For example, suppose the X axis synchronous action set is SYNC0, and if the user wants to activate the actions of SYNC0 in Y and Z axes when the activation factor of SYNC0 in X axis is activated, set D12 and D13 bits as 1 as shown in the table above. By these settings, when the activation factor of SYNC0 in X axis is activated, the actions of SYNC0 in Y and Z axes will be activated with the action of SYNC0 in X axis. At this time, the activation factor of SYNC0 in Y and Z axes must be set as NOP and only set the action. In addition, they must be enabled by synchronous action enable setting command.

Synchronous action set repeat setting

The user can specify whether the synchronous action set is disabled or not after that is invoked once.

To enable the repeat setting, set D15 bit (REP) as 1 and to enable only once, set it as 0.

When the repeat setting is enabled, the synchronous action is invoked every activation of the activation factor. When it is enabled only once, the synchronous action is invoked at the first activation of the activation factor.

[Note]

- When the repeat setting is enabled, if the activation factor sets “Termination of driving” and the action sets “Start of relative position driving”, the operation from the termination to the start of driving loops infinitely. This can be stopped by synchronous action disable setting command (cannot be stopped by termination command)

■ Enable setting

Each synchronous action set can be enabled by synchronous action enable setting command (81h~8Fh).

When the synchronous action set is enabled, the action is invoked by when the activation factor is activated.

4 synchronous action sets have each corresponding command code. Synchronous action set SYNC0 is 81h, SYNC1 is 82h, SYNC2 is 84h and SYNC3 is 88h. These commands can be enabled in combination simultaneously. For instance, if 83h is executed, SYNC0, 1 become enable. For more details of a combination of command codes, see table 2.6-7.

When REP=0 is set by SYNCm setting, once the synchronous action is executed, the synchronous action becomes disable and even if the activation factor is activated again, the synchronous action will not be executed. When REP=1 is set, the synchronous action set keeps enable after the synchronous action is executed.

To enable the synchronous action set that is disabled by execution of the synchronous action, synchronous action enable setting command must be written again.

When ERRDE=1 is set by PIO signal setting 2 · Other settings command (22h), all the synchronous action sets change to disable if an error occurs (when the error bit of RR0 register becomes 1). In this case, unless the error status is cleared, the synchronous action cannot be enabled by issuing synchronous action enable setting command. To clear the error status, write error/finishing status clear command (79h).

Enable/disable of 4 synchronous action sets can be checked by D3~D0 bits (SYNC3~SYNC0) of RR3 register Page1.

■ Disable setting

Each synchronous action set can be disabled by synchronous action disable setting command (91h~9Fh).

When the synchronous action set is disabled, the action is not invoked by when the activation factor is activated.

4 synchronous action sets are all disabled at reset.

4 synchronous action sets have each corresponding command code. Synchronous action set SYNC0 is 91h, SYNC1 is 92h, SYNC2 is 94h and SYNC3 is 98h. These commands can be disabled in combination simultaneously as well as synchronous action enable setting command. For more details of a combination of command codes, see table 2.6-7.

There are 3 occasions to change the state of a synchronous action to disable, “when synchronous action disable setting command is written”, “when an error occurs by PIO signal setting 2 · Other settings command (22h) when synchronous action disable setting (D7 : ERRDE) is set to enable”, and “after the synchronous action is activated when it is set once (disable the repeat setting)”.

Enable/disable of 4 synchronous action sets can be checked by D3~D0 bits (SYNC3~SYNC0) of RR3 register Page1.

Table 2.6-7 Enable/Disable and Command Code Corresponding to Synchronous Action Set

Command code (Hex)			Synchronous action set			
Enable setting	Disable setting	Activation	Synchronous action set 3 SYNC3	Synchronous action set 2 SYNC2	Synchronous action set 1 SYNC1	Synchronous action set 0 SYNC0
81	91	A1	—	—	—	○
82	92	A2	—	—	○	—
83	93	A3	—	—	○	○
84	94	A4	—	○	—	—
85	95	A5	—	○	—	○
86	96	A6	—	○	○	—
87	97	A7	—	○	○	○
88	98	A8	○	—	—	—
89	99	A9	○	—	—	○
8A	9A	AA	○	—	○	—
8B	9B	AB	○	—	○	○
8C	9C	AC	○	○	—	—
8D	9D	AD	○	○	—	○
8E	9E	AE	○	○	○	—
8F	9F	AF	○	○	○	○

○ : Enabled when enable setting command is executed and disabled when disable setting command is executed and activated when activation command is executed.

— : The state does not change when enable/disable setting command is executed. And not activated when activation command is executed.

2.6.4 Synchronous Action Execution

■ Execution steps of synchronous action

Synchronous action is performed as follows.

- ① Set the activation factor and action by synchronous action SYNCm setting command (26h~29h).
- ② Enable the synchronous action set by synchronous action enable setting command (81h~8Fh).
- ③ The synchronous action is activated when the activation factor that is set occurs.

■ Activation by synchronous action activation command

The synchronous action can also be activated by a command, which is the synchronous action activation command (A1h~Afh). Multiple synchronous action sets can be activated simultaneously by a command code. For the command code and corresponding synchronous action SYNC3~0, see table 2.6-7.

To activate a synchronous action by a synchronous action activation command, the user must enable a specified synchronous action set by a synchronous action enable setting command.

■ Synchronous action enable / disable state

The state of a synchronous action set can be checked by D3~D0 bits (SYNC3~SYNC0) of RR3 register Page1.

1 indicates enable of the synchronous action set, 0 indicates disable of the synchronous action set.

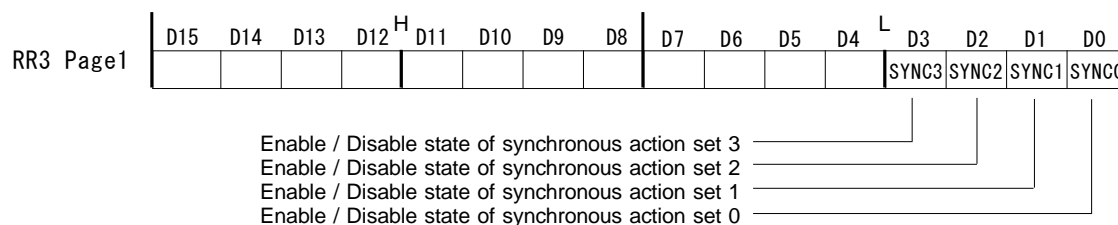

2.6.5 Interrupt by Synchronous Action

The user can generate an interrupt when a synchronous action is activated.

It is set to D15~D12 bits (SYNC3~SYNC0) of WR1 register.

When these bits are set as 1, an interrupt occurs when the activation factor of the synchronous action set corresponding to the bit is activated.

For more details of the interrupt, see chapter 2.10.

2.6.6 Examples of Synchronous Action

- Example 1 When passing through the position 15,000 during the driving in X axis, output synchronous pulses to XPIO0.

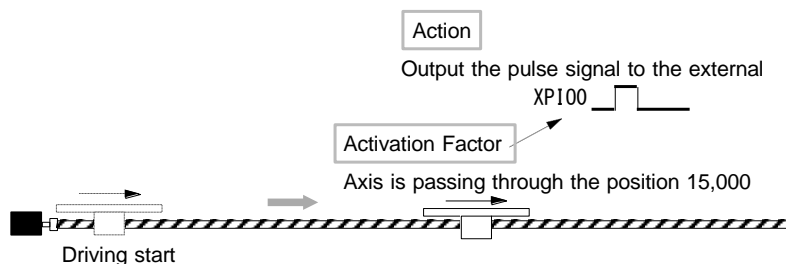

Fig. 2.6-8 Example 1: Synchronous Action

【Program Example】

```
// Drive setting (constant speed driving at 1000 PPS)
WR6 ← 1200h Write // Initial speed 8M PPS (maximum in specification)
WR7 ← 007Ah Write
WR0 ← 0104h Write

WR6 ← 03E8h Write // Drive speed 1000 PPS
WR7 ← 0000h Write
WR0 ← 0105h Write

WR6 ← 0000h Write // Logical position counter 0
WR7 ← 0000h Write
WR0 ← 0109h Write

// MR0 setting
WR6 ← 3A98h Write // MR0 15000
WR7 ← 0000h Write
WR0 ← 0110h Write

// Multi-purpose register mode setting
WR6 ← 0000h Write // D1,D0 00 M0T1,0 : MR0 Comparative object Logical position counter
// D3,D2 00 M0C1,0 : MR0 Comparison condition ≥
WR0 ← 0120h Write

// PIO signal setting 1
WR6 ← 0003h Write // D1,D0 11 P0M1,0 : PIO0 signal Synchronous action output
WR0 ← 0121h Write

// PIO signal setting 2
WR6 ← 0070h Write // D0 0 P0L : PIO0 Logical level of pulse signal Positive logic
// D6~D4 111 PW2~0 : Pulse width 1msec (at CLK = 16MHz)
WR0 ← 0122h Write

// Synchronous action setting
// Synchronous action SYNC0 setting
WR6 ← 0091h Write // D3~D0 0001 PRV3~0 : Activation factor MR0 object changed to True
// D8~D4 01001 ACT4~0 : Action synchronous pulse output
WR0 ← 0126h Write

// SYNC0 Enable
WR0 ← 0181h Write

// Start driving
WR0 ← 0152h Write // Starts+direction continuous pulse driving
```

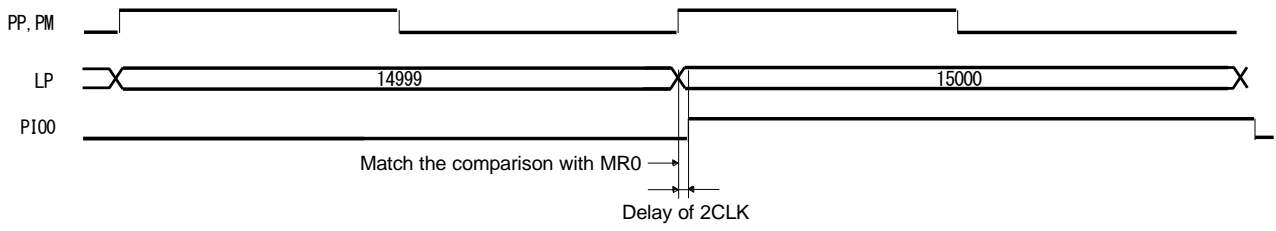

Fig. 2.6-7 Timing of Example 1: Synchronous Action

From chapter 2.6.7, a delay from the occurrence of an activation factor is 1CLK and a delay up to the action is 1CLK, so the delay time of this synchronous action is 2CLK (125nsec).

- Example 2 When an external signal is input during the driving in X axis, save the position data.

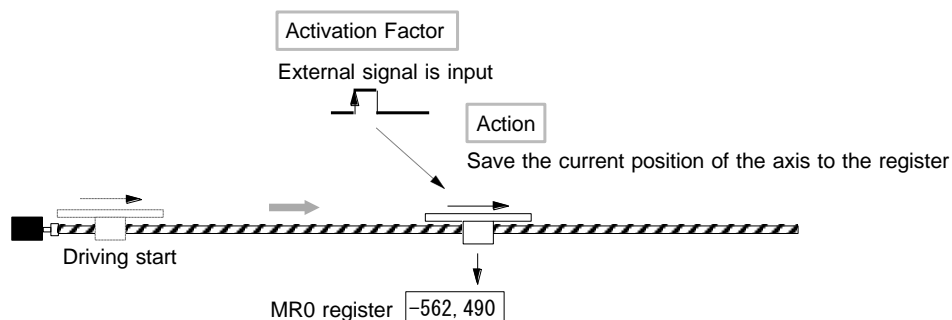

Fig. 2.6-8 Example 2: Synchronous Action

【Program Example】

```
// Drive setting (constant speed driving at 1000 PPS)
WR6 ← 1200h Write // Initial speed 8M PPS (maximum in specification)
WR7 ← 007Ah Write
WR0 ← 0104h Write

WR6 ← 03E8h Write // Drive speed 1000 PPS
WR7 ← 0000h Write
WR0 ← 0105h Write

WR6 ← 0000h Write // Logical position counter 0
WR7 ← 0000h Write
WR0 ← 0109h Write

// PIO signal setting 1
WR6 ← 0000h Write // D1,D0 00 P0M1,0 : PIO0 signal General purpose · Synchronous input
WR0 ← 0121h Write

// Interrupt setting
WR0 ← 011Fh Write // Select X axis
WR1 ← 1000h Write // D12 1 SYNC0 : When synchronous action SYNC0 is activated

// Synchronous action setting
// Synchronous action SYNC0 setting
WR6 ← 005Ah Write // D3~D0 1010 PRV3~0 : Activation factor XPIOm input ↑
// D8~D4 00101 ACT4~0 : Action Save LP → MRm
WR0 ← 0126h Write

// SYNC0 Enable
WR0 ← 0181h Write

// Start driving
WR0 ← 0152h Write // Starts + direction continuous pulse driving
```

↓

SYNC0 is activated and interrupt occurs

↓

```
// Read logical position counter value saved to MR0
WR0 ← 0134h Write
RR6 → Read
RR7 → Read
```

From chapter 2.6.7, a delay from the occurrence of an activation factor is from 0 (minimum) to 1CLK (maximum) and a delay up to the action is 1CLK, so the delay time of this synchronous action is from a minimum of 1CLK (62.5nsec) up to 2CLK (125nsec).

- Example 3 Calculates the time passing through from position A (10000) to position B (55000) during X axis driving.

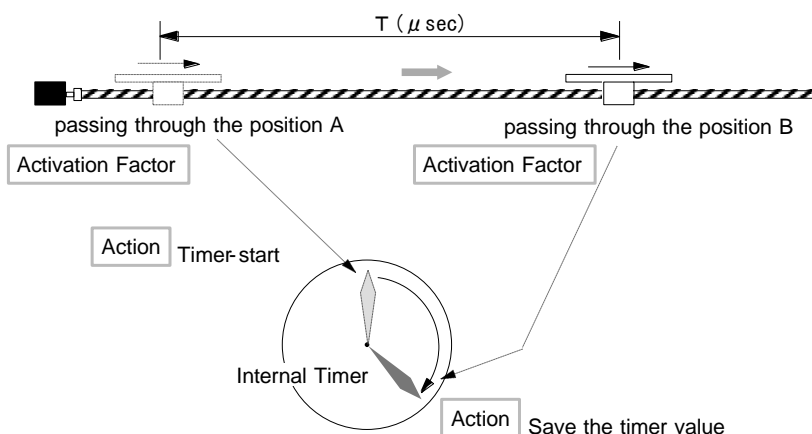

Fig. 2.6-9 Example 3: Synchronous Action

【Program Example】

```
// Drive setting (constant speed driving at 10K PPS)
WR6 ← 1200h Write           // Initial speed  8M PPS (maximum in specification)
WR7 ← 007Ah Write
WR0 ← 0104h Write

WR6 ← 2710h Write           // Drive speed  10K PPS
WR7 ← 0000h Write
WR0 ← 0105h Write

WR6 ← 0000h Write           // Logical position counter  0
WR7 ← 0000h Write
WR0 ← 0109h Write

// Set a specified position to MRm register
// MR0 setting (specified position A : 10000)
WR6 ← 2710h Write           // MR0  10000
WR7 ← 0000h Write
WR0 ← 0110h Write

// MR1 setting (specified position B : 55000)
WR6 ← D6D8h Write           // MR1  55000
WR7 ← 0000h Write
WR0 ← 0111h Write

// Timer value setting
WR6 ← FFFFh Write           // Timer value  2147483647 (maximum)
WR7 ← 7FFFh Write
WR0 ← 0116h Write

// Interrupt setting
WR0 ← 011Fh Write           // Select X axis
WR1 ← 2000h Write           // D13      1 SYNC1 : When synchronous action SYNC1 is activated

// Multi-purpose register mode setting
WR6 ← 0000h Write           // D1,D0    00 M0T1,0 : MR0 Comparative object   Logical position counter
                               // D3,D2    00 M0C1,0 : MR0 Comparison condition ≧
                               // D5,D4    00 M1T1,0 : MR1 Comparative object   Logical position counter
                               // D7,D6    00 M1C1,0 : MR1 Comparison condition ≧

WR0 ← 0120h Write

// Synchronous action setting
// Synchronous action SYNC0 setting
WR6 ← 0151h Write           // D3~D0    0001 PRV3~0  : Activation factor  MRm object changed to True
                               // D8~D4    10101 ACT4~0  : Action    Timer-start

WR0 ← 0126h Write

// Synchronous action SYNC1 setting
WR6 ← 0071h Write           // D3~D0    0001 PRV3~0  : Activation factor  MRm object changed to True
                               // D8~D4    00111 ACT4~0  : Action    Save  CT → MRm

WR0 ← 0127h Write

// SYNC0,1 Enable
```

WR0 ← 0183h Write

// Start driving

WR0 ← 0152h Write

// Starts +direction continuous pulse driving



SYNC0 is activated and interrupt occurs
by XPIO0 input (Low→Hi level)



// Read timer value saved to MR1

WR0 ← 0135h Write

RR6 → Read

RR7 → Read

// Timer-stop

WR0 ← 0174h Write

2.6.7 Synchronous Action Delay Time

A synchronous action delay is a total of the delay from the occurrence of an activation factor to an action as shown in the tables below.

■ Delay from the occurrence of an activation factor

1CLK=62.5nsec (CLK=16MHz)

Table 2.6-8 Delay from the Occurrence of an Activation Factor

Activation factor		Definition of the start of delay	Delay time (CLK)		
			Min.	Standard	Max.
MRm comparison changed to True	Logical position counter	From ↑ of the driving pulse when the LP value satisfies the comparison condition with MRm value		1	
	Real position counter	From ↓ of the nECA/B input signal when the RP value satisfies the comparison condition with MRm value	2		3
	Current drive speed	From when the current drive speed satisfies the comparison condition with MRm value		1	
	Current timer value	From when the current timer value satisfies the comparison condition with MRm value		1	
Timer is up		From when the current timer value reaches a specified value		0	
Start of driving		From ↑ of the WRN signal at writing of a driving command	2		3
Start of driving at constant speed area in acceleration / deceleration driving.		From ↑ of the CNST signal		0	
Termination of driving at constant speed area in acceleration / deceleration driving.		From ↓ of the CNST signal		0	
Termination of driving		From Low level termination of the last driving pulse		1	
Start of split pulse		From ↑ of the 1st nSPLTP signal (when starting pulse is enabled)		0	
Termination of split pulse		From ↓ of the last nSPLTP signal (positive logic)		2	
Output of split pulse		From ↑ of the nSPLTP signal (positive logic)		0	
nPIOm input↑		From ↑ of the nPIOm signal (when the built-in filter is disabled)	0		1
nPIOm input↓		From ↓ of the nPIOm signal (when the built-in filter is disabled)	0		1
nPIOm input Low and nPIO(m +4)↑		From ↑ of the nPIO(m +4) signal (when the built-in filter is disabled)	0		1
nPIOm input Hi and nPIO(m +4)↑		From ↑ of the nPIO(m +4) signal (when the built-in filter is disabled)	0		1
nPIOm input Low and nPIO(m +4)↓		From ↓ of the nPIO(m +4) signal (when the built-in filter is disabled)	0		1
nPIOm input Hi and nPIO(m +4)↓		From ↓ of the nPIO(m +4) signal (when the built-in filter is disabled)	0		1
Activation command		From ↑ of the WRN signal at writing of a synchronous action activation command	1		2

■ Delay up to an action

1CLK=62.5nsec (CLK=16MHz)

Table 2.6-9 Delay up to an Action

Action	Definition of the end of delay	Delay time (CLK)
Load MRm → DV	Until the MRm value is loaded into DV	1
Load MRm → TP	Until the MRm value is loaded into TP	1
Load MRm → SP1	Until the MRm value is loaded into SP1	1
Load MRm → LP (SYNC0), RP (SYNC1), SV (SYNC2), AC (SYNC3)	Until the MRm value is loaded into LP (SYNC0), RP (SYNC1), SV (SYNC2), AC (SYNC3)	1
Save LP → MRm	Until the LP value is saved to MRm	1
Save RP → MRm	Until the RP value is saved to MRm	1
Save CT → MRm	Until the CT value is saved to MRm	1
Save CV (SYNC0), CA (SYNC1) → MRm	Until the CV (SYNC0), CA (SYNC1) values are saved to MRm	1
Synchronous pulse nPIOm output	Until ↑ of the synchronous pulse nPIOm signal	1
Start of relative position driving	Until ↑ of the 1st driving pulse	3
Start of counter relative position driving	Until ↑ of the 1st driving pulse	3
Start of absolute position driving	Until ↑ of the 1st driving pulse	3
Start of + direction continuous pulse driving	Until ↑ of the 1st driving pulse	3
Start of - direction continuous pulse driving	Until ↑ of the 1st driving pulse	3
Relative position driving by drive pulse number of MRm value	Until ↑ of the 1st driving pulse	4
Absolute position driving to the finish point of MRm value	Until ↑ of the 1st driving pulse	4
Decelerating stop	Until the start of deceleration	(※1)
Instant stop	Until the termination of driving	(※1)
Drive speed increase	Until drive speed increase is started toward the changed speed.	1
Drive speed decrease	Until drive speed decrease is started toward the changed speed.	1
Timer-start	Until the timer-start	1
Timer-stop	Until the timer-stop	1
Start of split pulse	Until ↑ of the nSPLTP signal (with starting pulse)	(※2)
Termination of split pulse	Until ↓ of the nSPLTP signal	(※3)
Interrupt	Until ↓ of the INTON signal	1

(※1) The time until the one driving pulse being output is finished.

(※2) Since the split pulse is synchronized with the driving pulse, the delay will be 1 driving pulse cycle at the maximum.

(※3) The time until the split pulse being output is finished.

■ Calculation example of delay

For instance, the delay time from the activation factor “↑ of the nPIOm input” to the action “Save LP →MRm” is a total of the “↑ of the nPIOm input” delay time (0 to 1CLK) and “Save LP →MRm” delay time (1CLK), that is from a minimum of 1CLK up to 2CLK. The range is from a minimum of 62.5nsec up to 125nsec when CLK=16MHz.

■ Delay by the activation of the other SYNC

If the other SYNC is activated, the action will be activated with 1CLK delay compared to the action of self-synchronous action set.

■ Delay by the activation of SYNC0 in another axis

If SYNC0 of another axis is activated, the action will be activated with 1CLK delay compared to the action of self-synchronous action set.

2.7 Split Pulse

This is a function that outputs the split pulse which is synchronized with a drive pulse during the driving in each axis. This function is useful when the user wants to perform the other operation at regular pulse intervals, synchronizing with rotation of a motor and axis driving.

And it can be output during interpolation driving as well.

The pulse width of a split pulse, split length (cycle) and split pulse number can be set. And the logical level of pulses and with or without starting pulse can be specified. Split pulses are output from the pin shown in the table 2.7-1.

Table 2.7-1 Split pulse Pin Number in each axis

Axis	Signal	Pin Number
X	XSPLTP	65
Y	YSPLTP	84
Z	ZSPLTP	103
U	USPLTP	122

While driving, start of split pulse can be performed by a command or a synchronous action. When using a synchronous action, the user can start from a specified value of a position counter or \uparrow of an external signal.

Split pulse example of Split length = 7, Pulse width = 3, Split pulse number = 5 and Positive logic

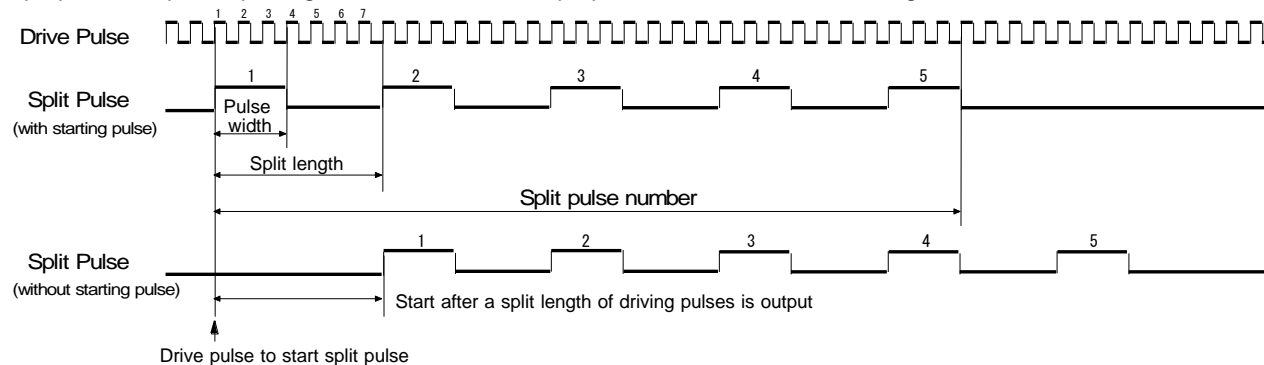

Fig. 2.7-1 Example of Split Pulse

2.7.1 Split Pulse Setting

To perform the split pulse, the following parameters and mode setting must be set.

■ Split length and pulse width setting

A split length and pulse width can be set by split pulse setting 1 command (17h). Set a split length to WR6 register and a pulse width to WR7 register. The unit of split length and pulse width is the number of drive pulses.

Because of the function of split pulse, set split length > pulse width.

A split length can be set within the range of 2~65535 and a pulse width can be set within the range of 1~65534.

The user can check the settings by split pulse setting 1 reading command (47h).

A split length (cycle) and pulse width can be altered while the split pulse is in operation.

■ Split pulse number setting

The split pulse number can be set by split pulse setting 2 command (18h). Set the split pulse number to WR6 register.

It can be set within the range of 0~65535. If 0 is set, it becomes infinite. After starting, it continues to output split pulses until termination of split pulse command is written or driving is stopped.

The split pulse number can be altered while the split pulse is in operation.

■ Split pulse mode setting

The operating mode of split pulses can be set by PIO signal setting 2 • Other settings command (22h).

At the start of split pulse, set with or without starting pulse, and the logical level of split pulse output to D10, D11 bits of WR6 register.

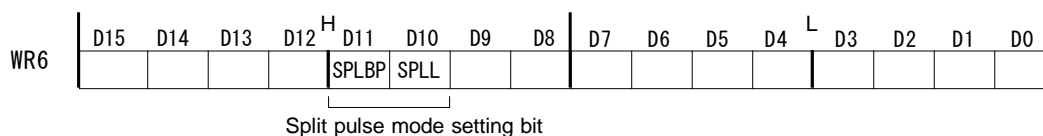

Set the split pulse logic to D10 bit (SPLL).

As shown below, when 0 is set, it is positive logic pulse and when 1 is set, it is negative logic pulse.



Fig. 2.7-2 Split Pulse Logic

Set with or without starting pulse to D11 bit (SPLBP).

When 1 is set to D11 bit (SPLBP), it starts with starting pulse and when 0 is set, it starts without starting pulse.

When with starting pulse is specified, after the start of split pulse, split pulses are output from next driving pulse. When without starting pulse is specified, after the start of split pulse, the first split pulse is output after a split length of driving pulses is output.

2.7.2 Start / Termination of Split Pulse

■ Start of split pulse

Split pulse is started by start of split pulse command (75h) or a synchronous action.

When a command is written or the action of a synchronous action is started, next driving pulse is the starting drive pulse of split pulse.

■ Termination of Split Pulse

Output of split pulse is terminated by any one of the following 3 behaviors.

- When output of specified split pulses is finished.
- When requested to stop by termination of split pulse command or the action of a synchronous action.
- When driving stops.

After output of specified split pulses is finished, it will stop when the last split pulse of specified split pulses becomes OFF.

When split pulse is stopped by termination of split pulse command (76h) or a synchronous action, if the split pulse is ON, it will stop after the split length of pulses is output. If it is OFF, it will stop at the timing of termination of split pulse command or execution of a synchronous action.

When output of split pulse is terminated by the stop of driving, regardless of split pulse output state, the split pulse becomes OFF and terminates at the timing of the stop of driving.

■ Check of Split Pulse Operation

Split pulse in operation can be checked by D11 bit (SPLIT) of RR3 register Page1.

When D11 bit (SPLIT) is 1, split pulse is in operation and when it is 0, split pulse is stopped.

2.7.3 Split Pulse in Synchronous Action

Split pulse can be operated by a synchronous action.

As the activation factor of a synchronous action, the following 3 types can be specified: “at the start of split pulse”, “at the output of split pulse” and “at the termination of split pulse”.

As the action of a synchronous action, the following 3 types can be specified: “at the start of split pulse”, “at the termination of split pulse” and “load the data of a multi-purpose register to the split pulse data (split length and pulse width)”

For more details of these functions, see chapter 2.6.

2.7.4 Interrupt by Split Pulse

An interrupt related to split pulse operation can be generated.

Set them to D10, D11 bits of WR1 register.

When D10 bit (SPLTP) is 1, an interrupt occurs at the \uparrow of a pulse in each split pulse (when the split pulse logic is positive).

When D11bit (SPLTE) is 1, an interrupt occurs when operation of split pulse is finished.

For more details of the interrupt function, see chapter 2.10.

2.7.5 Notes on Split Pulse

- When with starting pulse is enabled, only the first pulse is different in the timing of output. For more details, see chapter 11.7.
- While operating split pulse, if it stops by such as a command before output of specified split pulses is finished and then restarts split pulse again, it starts to count the split pulse number from 1.

2.7.6 Examples of Split Pulse

■ Example 1 Split pulse starts from the start of X axis driving.

After issuing start of split pulse command, driving starts and split pulses are output with driving.

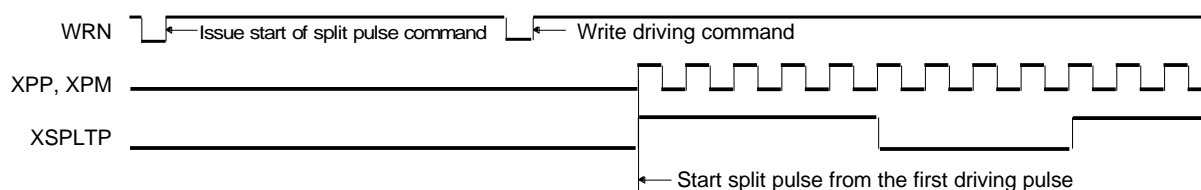

Fig. 2.7-3 Timing of Split Pulse Output by Start of Driving

【Program Example】

```
// Drive setting (constant speed driving at 1000 PPS)
WR6 ← 1200h Write // Initial speed 8M PPS (maximum in specification)
WR7 ← 007Ah Write
WR0 ← 0104h Write

WR6 ← 03E8h Write // Drive speed 1000 PPS
WR7 ← 0000h Write
WR0 ← 0105h Write

WR6 ← 0000h Write // Logical position counter 0
WR7 ← 0000h Write
WR0 ← 0109h Write

// Split pulse setting
// Split length, pulse width setting
WR6 ← 0009h Write // Split length 9
WR7 ← 0005h Write // Pulse width 5
WR0 ← 0117h Write

// Split pulse number setting
WR6 ← 000Ah Write // Split pulse number 10
WR0 ← 0118h Write

// Split pulse logic, starting pulse setting
WR6 ← 0800h Write // D10 0 SPLL : Pulse logic Positive
// D11 1 SPLBP : With starting pulse
WR0 ← 0122h Write

// Start split (write start of split pulse command before starting the drive)
WR0 ← 0175h Write

// Start driving
WR0 ← 0152h Write // Starts+direction continuous pulse driving
```

After starting the drive, the first driving pulse becomes the starting drive pulse of split pulse.

After start of split pulse command is written, split pulses are not output unless driving starts, but D11 bit (SPLIT) of RR3 register Page1 becomes 1 at the timing of when start of split pulse command is written.

■ Example 2 Split pulse starts from position 5,000 in X axis.

After starting the drive, split pulse starts from when the logical position reaches to 5,000. This is performed by the function of a synchronous action.

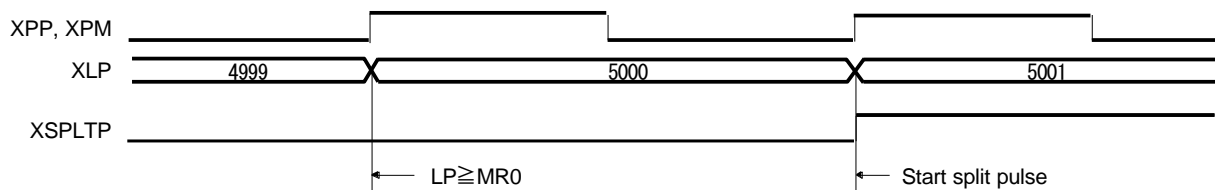

Fig. 2.7-4 Timing of Split Pulse Output by Comparison with MRm

【Program Example】

```
// Drive setting (constant speed driving at 1000 PPS)
WR6 ← 1200h Write // Initial speed 8M PPS (maximum in specification)
WR7 ← 007Ah Write
WR0 ← 0104h Write

WR6 ← 03E8h Write // Drive speed 1000 PPS
WR7 ← 0000h Write
WR0 ← 0105h Write

WR6 ← 0000h Write // Logical position counter 0
WR7 ← 0000h Write
WR0 ← 0109h Write

// Split pulse setting
// Split length, pulse width setting
WR6 ← 0008h Write // Split length 8
WR7 ← 0005h Write // Pulse width 5
WR0 ← 0117h Write

// Split pulse number setting
WR6 ← 000Ah Write // Split pulse number 10
WR0 ← 0118h Write

// Split pulse logic, starting pulse setting
WR6 ← 0800h Write // D10 0 SPLL : Pulse logic Positive
// D11 1 SPLBP : With starting pulse
WR0 ← 0122h Write

// Multi-purpose register setting
// MR0 setting
WR6 ← 1388h Write // MR0 5000
WR7 ← 0000h Write
WR0 ← 0110h Write

// Multi-purpose register mode setting
WR6 ← 0000h Write // D1,D0 00 M0T1,0 : MR0 Comparative object Logical position counter
// D3,D2 00 M0C1,0 : MR0 Comparison condition ≥
WR0 ← 0120h Write

// Synchronous action setting
// Synchronous action SYNC0 setting
WR6 ← 0171h Write // D3~D0 0001 PRV3~0 : Activation factor MRm object changed to True
// D8~D4 10111 ACT4~0 : Action start of split pulse
WR0 ← 0126h Write

// SYNC0 Enable
WR0 ← 0181h Write

// Start driving
WR0 ← 0152h Write // Starts+direction continuous pulse driving
```

If the comparative value is 5,000 and comparison condition is \geq , the value of the logical position counter that split pulse is started is 5001 as shown in the figure. That is, next driving pulse is the starting drive pulse when comparison condition changed to True.

■ Example 3 Split pulses are output at constant speed area during S-curve acceleration /deceleration driving in X axis.

At constant speed area during S-curve acceleration /deceleration driving, split pulses are output. This is performed by the function of a synchronous action.

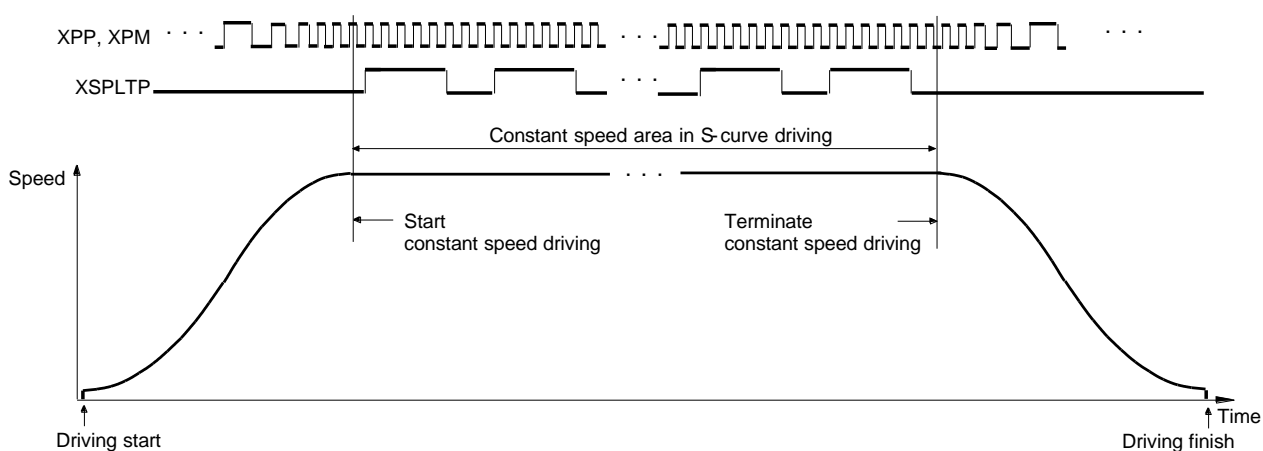

Fig. 2.7-5 Output of Split Pulses at Constant Speed Area in S-curve Driving

【Program Example】

```
// S-curve acceleration /deceleration drive setting
WR6 ← 000Ah Write           // Initial speed  10 PPS
WR7 ← 0000h Write
WR0 ← 0104h Write

WR6 ← 0FA0h Write           // Drive speed  4000 PPS
WR7 ← 0000h Write
WR0 ← 0105h Write

WR6 ← FFFFh Write           // Acceleration  536870911(maximum)
WR7 ← 1FFFh Write
WR0 ← 0102h Write

WR6 ← A048h Write           // Jerk  893K PPS/SEC2
WR7 ← 000Dh Write
WR0 ← 0100h Write

WR6 ← 9C40h Write           // Drive pulse number  40000
WR7 ← 0000h Write
WR0 ← 0106h Write

WR6 ← 0000h Write           // Logical position counter  0
WR7 ← 0000h Write
WR0 ← 0109h Write

WR3 ← 0104h Write           // D3          1 SACC : S-curve acceleration /deceleration

// Split pulse setting
// Split length, pulse width setting
WR6 ← 0008h Write           // Split length  8
WR7 ← 0005h Write           // Pulse width   5
WR0 ← 0117h Write

// Split pulse number setting
WR6 ← 0000h Write           // Split pulse number  Infinite
WR0 ← 0118h Write

// Split pulse logic, starting pulse setting
WR6 ← 0800h Write           // D10          0 SPLL : Pulse logic  Positive
                               // D11          1 SPLBP : With starting pulse
WR0 ← 0122h Write

// Synchronous action setting
// Synchronous action SYNC0 setting
WR6 ← 0174h Write           // D3~D0       0100 PRV3~0 : Activation factor  Start constant speed driving
                               // D8~D4       10111 ACT4~0 : Action      start of split pulse
                               // D15        0 REP          : Repeat      must be disabled
WR0 ← 0126h Write
```

```
// Synchronous action SYNC1 setting
WR6 ← 0185h Write           // D3~D0   0101 PRV3~0 : Activation factor   Finish constant speed driving
                             // D8~D4   11000 ACT4~0 : Action      termination of split pulse
                             // D15   0 REP      : Repeat      must be disabled

WR0 ← 0127h Write

// SYNC0,1 Enable
WR0 ← 0183h Write

// Start driving
WR0 ← 0150h Write           // Starts relative position driving
```

■ **Example 4** Starts to output split pulses from position 5,000 in X axis and changes split length and pulse width from position 10,000

Split pulse starts from the logical position 5,000 and changes a split length and pulse width from the logical position 10,000, and then outputs the rest of split pulses. This is performed by the function of a synchronous action.

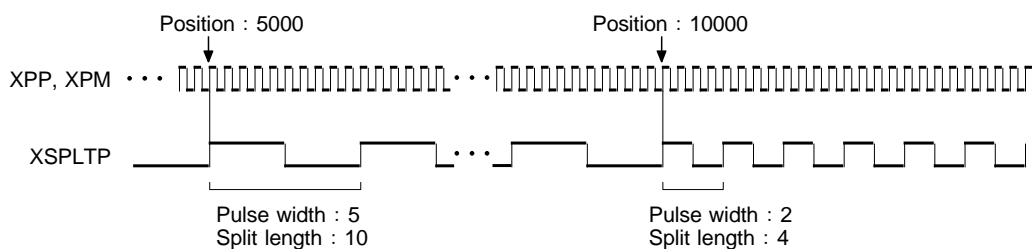

Fig. 2.7-6 Change Split Length and Pulse Width at Specified Position during the Driving

【Program Example】

```
// Drive setting (constant speed driving at 1000 PPS)
WR6 ← 1200h Write // Initial speed 8M PPS (maximum)
WR7 ← 007Ah Write
WR0 ← 0104h Write

WR6 ← 03E8h Write // Drive speed 1000 PPS
WR7 ← 0000h Write
WR0 ← 0105h Write

WR6 ← 0000h Write // Logical position counter 0
WR7 ← 0000h Write
WR0 ← 0109h Write

WR6 ← 2EE0h Write // Drive pulse number 12000
WR7 ← 0000h Write
WR0 ← 0106h Write

// Split pulse setting
// Split length, pulse width setting
WR6 ← 000Ah Write // Split length 10
WR7 ← 0005h Write // Pulse width 5
WR0 ← 0117h Write

// Split pulse number setting
WR6 ← 0320h Write // Split pulse number 800
WR0 ← 0118h Write

// Split pulse logic, starting pulse setting
WR6 ← 0800h Write // D10 0 SPLL : Pulse logic Positive
// D11 1 SPLBP : With starting pulse
WR0 ← 0122h Write

// Multi-purpose register setting
// MR0 setting
WR6 ← 1387h Write // MR0 4999
WR7 ← 0000h Write
WR0 ← 0110h Write

// MR1 setting
WR6 ← 2710h Write // MR1 10000
WR7 ← 0000h Write
WR0 ← 0111h Write

// MR2 setting
WR6 ← 0004h Write // Split length 4
WR7 ← 0002h Write // Pulse width 2
WR0 ← 0112h Write

// Multi-purpose register mode setting
WR6 ← 0000h Write // D1,D0 00 M0T1,0 : MR0 Comparative object ≥ Logical position counter
// D3,D2 00 M0C1,0 : MR0 Comparison condition ≥
// D5,D4 00 M1T1,0 : MR1 Comparative object ≥ Logical position counter
// D7,D6 00 M1C1,0 : MR1 Comparison condition ≥

WR0 ← 0120h Write
```

```

// Synchronous action setting
// Synchronous action SYNC0 setting
WR6 ← 0171h Write           // D3~D0    0001 PRV3~0    : Activation factor  MRm object changed to True
                               // D8~D4    10111 ACT4~0   : Action    start of split pulse
WR0 ← 0126h Write

// Synchronous action SYNC1 setting
WR6 ← 0201h Write           // D3~D0    0001 PRV3~0    : Activation factor  MRm object changed to True
                               // D8~D4    00000 ACT4~0  : Action    NOP
                               // D11~D9   001 SNC+3,2,1  : Other SYNC Activation  Activate SNC+1
WR0 ← 0127h Write

// Synchronous action SYNC2 setting
WR6 ← 0030h Write           // D3~D0    0001 PRV3~0    : Activation factor  NOP
                               // D8~D4    00011 ACT4~0  : Action    Load MRm → SP1
                               // D11~D9   001 SNC+3,2,1  : Other SYNC Activation  Activate SNC+1
WR0 ← 0128h Write

// SYNC2~0 Enable
WR0 ← 0187h Write

// Start driving
WR0 ← 0150h Write           // Starts relative position driving

```

In this case, if split pulse is set to output at the timing of position 4,999, it actually starts to output from position 5,000.

[Note]

- In this case, while operating split pulse, the user must use caution with changing a split length and pulse width by such as a synchronous action. Because split pulses around the change may cause unexpected behavior due to the timing of change.

2.8 General Purpose Input / Output Signal

MCX514 has 8 general purpose input / output pins in each axis, nPIO7~0.

When not using the input signal that has a specific function, disable its function, and it can be used as a general purpose input signal.

2.8.1 nPIOm Signal

nPIOm signal can be used as input/output signals for various purposes as shown below.

- 1) General purpose input signal
- 2) General purpose output signal
- 3) Input signal as the activation factor of a synchronous action
- 4) Synchronous pulse output signal as the action of a synchronous action
- 5) Output signal to output drive status
- 6) Output signal to output the comparison result of a multi-purpose register
- 7) Input signal for driving by external signals

■ nPIOm signal function setting

The function of nPIOm signals can be set by PIO signal setting 1 command (21h).

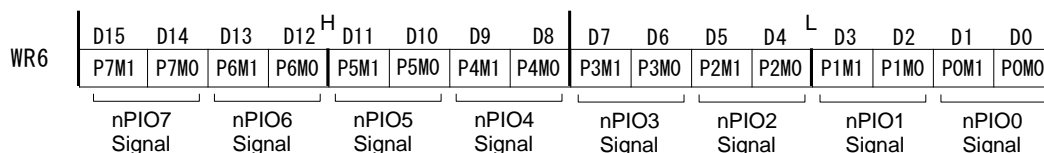

Set 2 bits corresponding to each nPIOm signal of WR6 register according to purposes.

The functions corresponding to 2 bits of each nPIOm signal are shown in the table below.

Table 2.8-1 nPIOm Signal Function Setting

PKM1 bit	PKM0 bit	Function
0	0	General purpose input nPIO7~0 signals become an input state. In synchronous action, it can be activated by the signals ↑ or ↓. In driving by external signals, relative position driving or continuous pulse driving can be activated by nPIO4, 5 signals.
0	1	General purpose output nPIO7~0 signals become an output state.
1	0	Drive status output nPIO7~0 signals become an output state and output the drive status.
1	1	Synchronous pulse · MRm comparison output nPIO7~0 signals become an output state. nPIO3~0 output synchronous pulses and nPIO7~4 output MRm comparison value.

(k:0~7)

■ nPIOm signal reading

The signal levels of nPIOm signals can be read out by RR4, RR5 registers anytime regardless of input/output.

X axis is from D7~D0 bits (XPIO7~XPIO0) of RR4 register, Y axis is from D15~D8 bits (YPIO7~YPIO0), Z axis is from D7~D0 bits (ZPIO7~ZPIO0) and U axis is from D15~D8 bits (UPIO7~UPIO0).

When the signal is Low level, 0 is displayed and when the signal is Hi level, 1 is displayed.

RR4	D15	D14	D13	D12 ^H	D11	D10	D9	D8	D7	D6	D5	D4 ^L	D3	D2	D1	D0
	YPIO7	YPIO6	YPIO5	YPIO4	YPIO3	YPIO2	YPIO1	YPIO0	XPIO7	XPIO6	XPIO5	XPIO4	XPIO3	XPIO2	XPIO1	XPIO0
RR5	D15	D14	D13	D12 ^H	D11	D10	D9	D8	D7	D6	D5	D4 ^L	D3	D2	D1	D0
	UPIO7	UPIO6	UPIO5	UPIO4	UPIO3	UPIO2	UPIO1	UPIO0	ZPIO7	ZPIO6	ZPIO5	ZPIO4	ZPIO3	ZPIO2	ZPIO1	ZPIO0

■ General purpose input

As the functions of an input signal, there are 3 kinds of input signals, general purpose input signal, synchronous input signal and input signal for driving.

Set 2 bits corresponding to nPIOm signal as 0, 0 and the signals are set by PIO signal setting 1 command (21h).

Used as general purpose input signal

The signal levels of nPIO7~0 signals are displayed in RR4, RR5 registers. X axis is from D7~D0 bits (XPIO7~XPIO0) of RR4 register, Y axis is from D15~D8 bits (YPIO7~YPIO0), Z axis is from D7~D0 bits (ZPIO7~ZPIO0) and U axis is from D15~D8 bits (UPIO7~UPIO0). When the signal is Low level, 0 is displayed and when the signal is Hi level, 1 is displayed.

Used as synchronous input signal

Input change of nPIOm signals can be used as the activation factor of a synchronous action.

For more details of the synchronous action, see chapter 2.6.

Used as input signal for driving by external signals

Relative position driving or continuous pulse driving can be activated by nPIOm signal and but a command.

Perform by using nPIO4, nPIO5 signals, and driving will be activated by the input state or input change of these signals.

For more details of driving by external signals, see chapter 2.12.1.

■ General purpose output

Set 2 bits corresponding to nPIOm signal as 0, 1 and the signals are set by PIO signal setting 1 command (21h).

Writing into nPIOm signal is performed by writing into WR4, WR5 registers. X axis is to D7~D0 bits (XPIO7~XPIO0) of WR4register, Y axis is to D15~D8 bits (YPIO7~YPIO0) of WR4register, Z axis is to D7~D0 bits (ZPIO7~ZPIO0) of WR5register and U axis is to D15~D8 bits (UPIO7~UPIO0) WR5register. The values written in each bit are output to PIO7~0 signals in each axis. When 0 is written in the bit, it is Low level output and when 1 is written, it is Hi level output.

WR4	D15	D14	D13	D12 ^H	D11	D10	D9	D8	D7	D6	D5	D4 ^L	D3	D2	D1	D0
	YPIO7	YPIO6	YPIO5	YPIO4	YPIO3	YPIO2	YPIO1	YPIO0	XPIO7	XPIO6	XPIO5	XPIO4	XPIO3	XPIO2	XPIO1	XPIO0
WR5	D15	D14	D13	D12 ^H	D11	D10	D9	D8	D7	D6	D5	D4 ^L	D3	D2	D1	D0
	UPIO7	UPIO6	UPIO5	UPIO4	UPIO3	UPIO2	UPIO1	UPIO0	ZPIO7	ZPIO6	ZPIO5	ZPIO4	ZPIO3	ZPIO2	ZPIO1	ZPIO0

■ Drive status output

Drive status can be output to nPIOm signal.

Set 2 bits corresponding to nPIOm signal as 1, 0 and the signals are set by PIO signal setting 1 command (21h).

Drive status such as driving, accelerating and decelerating is output from nPIOm signal.

For more details of the status output, see chapter 2.12.7.

■ Synchronous pulse · MRm comparison output

Set 2 bits corresponding to nPIOm signal as 1, 1 and the signals are set by PIO signal setting 1 command (21h).

Used as synchronous pulse output signal

As the action of a synchronous action, synchronous pulses can be output to nPIO0~nPIO3 signals.

For more details of the synchronous action, see chapter 2.6.

Used as MRm comparison output signal

The comparison result of MRm register can be output to nPIOm signal.

MR0~MR3 comparison output is output from nPIO4~nPIO7 signals.

For more details of the MRm register, see chapter 2.4.

[Note] Note for using as output signal

nPIOm signal is pulled up to VDD with 50kΩ(Typ.) resistor inside MCX514. nPIOm signal is set to general input signal at reset. Please note that the terminal voltage of nPIOm signal is at High level with 50kΩ pull-up until this signal is set to output by PIO signal setting 1 command (21h).

Pull-up resistor inside MCX514 is 50kΩ standard, 20kΩ minimum and 120kΩ maximum.

2.8.2 Other Input Signals

As shown in the table below, about input signals other than nPIOm signals, when the functions of those signals are not used, they can be used as a general purpose input signal.

The signal levels of input signals are displayed in RR3 register Page0. When the signal is Low level, 0 is displayed and when the signal is Hi level, 1 is displayed.

Input signals that can be used as a general purpose input signal are shown in the table below.

Table 2.8-2 Input signals can be used as general purpose input signal

Input signal (Pin number)	Function of the input signal	Bit of RR3 register Page0 in each Axis	
XSTOP0(74) YSTOP0(93) ZSTOP0(112) USTOP0(131)	Driving stop signal	D0 bit (STOP0)	RR3 status display 0:Low level 1:Hi level
XSTOP1(73) YSTOP1(92) ZSTOP1(111) USTOP1(130)	Driving stop signal	D1 bit (STOP1)	
XSTOP2(70) YSTOP2(91) ZSTOP2(110) USTOP2(129)	Driving stop signal	D2 bit (STOP2)	
XECA(45) YECA(47) ZECA(49) UECA(51)	Encoder A-phase signal	D3 bit (ECA)	
XECB(46) YECB(48) ZECB(50) UECB(52)	Encoder B-phase signal	D4 bit (ECB)	
XINPOS(66) YINPOS(85) ZINPOS(104) UINPOS(123)	In-position input signal from a servo driver	D5 bit (INPOS)	
XALARM(67) YALARM(86) ZALARM(105) UALARM(124)	Alarm signal from a servo driver	D6 bit (ALARM)	
XLMTM(68) YLMTM(87) ZLMTM(106) ULMTM(127)	+ direction hardware limit signal	D7 bit (LMTP)	
XLMTM(69) YLMTM(88) ZLMTM(109) ULMTM(128)	− direction hardware limit signal	D8 bit (LMTM)	

2.9 Timer

MCX514 is equipped with one timer in each axis, which can set with the range of 1 ~ 2,147,483,647 μ sec in increments of 1 μ sec (at CLK = 16MHz).

By using with synchronous action, various operations which combine a motor drive and timer functions can be performed precisely. The followings are some of examples.

- After the termination of driving, driving starts after the elapse of a specified time.

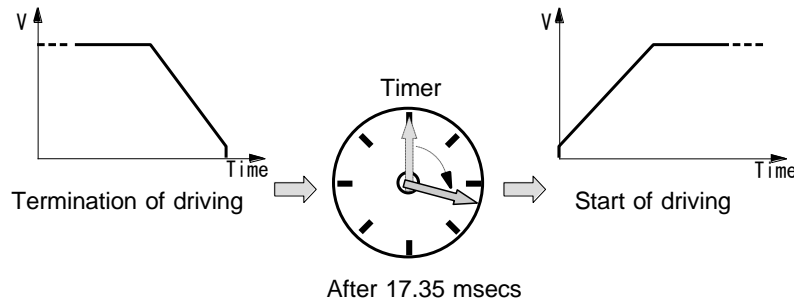

Fig. 2.9-1 Example 1 of Timer Operation

- Designated drive pulses are output with a specified time period correctly.

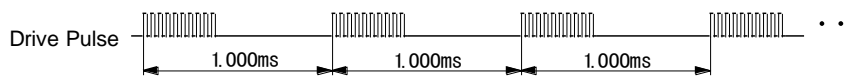

Fig. 2.9-2 Example 2 of Timer Operation

- Performs decelerating stop after driving at constant speed for a specified time in acceleration/deceleration driving.

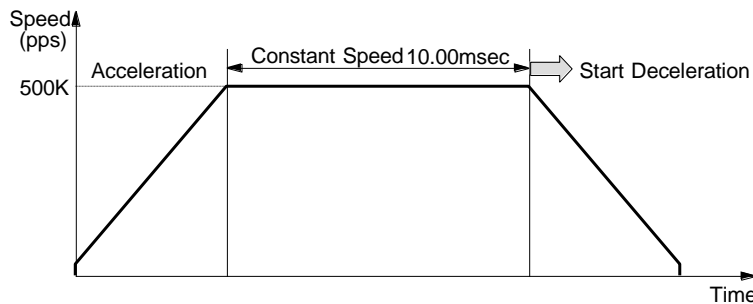

Fig. 2.9-3 Example 3 of Timer Operation

2.9.1 Timer Operation

MCX514 has a 31-bit length timer counter. When a timer is started, it counts up from 0 in increments of 1 μ sec, and when the count reaches the value specified by the timer value (the time is up), then the timer stops. When the operation mode of a timer is set to “once”, the timer operation is finished when the timer expires. When the operation mode of a timer is set to “repeat”, the count starts to count up from 0 again after the timer expires. And it repeats the operation unless the timer is stopped by timer-stop command or a synchronous action.

Expiring of a timer can be set as the activation factor of a synchronous action, and various operations such as the start of driving or output of an external signal can be performed. For more details of the synchronous action, see chapter 2.6.

In addition, when a timer expires, the user can generate an interrupt signal and so it is possible to perform the operation in synchronization with the CPU.

2.9.2 Timer Setting

To operate a timer, the timer value and operation mode (once / repeat) must be set.

■ Timer value setting

A timer value can be set by timer value setting command (16h). Set values to WR6, 7 registers and write timer value setting command (16h) into WR0 register, and then it will be set. It can be set with the range of 1 ~ 2,147,483,647 μ sec in increments of 1 μ sec (See chapter 7.2.23).

The timer value can be changed while operating a timer.

■ Timer operation mode setting

Set the operation mode of a timer to D14 bit (TMMD) of WR3 register.

When 0 is set to D14 bit (TMMD), the timer operates once and when 1 is set, the timer operates repeatedly.

2.9.3 Timer-Start / Timer-Stop

■ Timer-start

A timer is started by timer-start command (73h) or the activation of the synchronous action that timer-start is set as the action.

■ Timer-stop

In the operation mode is once, a timer stops when the count reaches the value specified by the timer value (the time is up). While operating a timer, it can be stopped by timer-stop command (74h) or a synchronous action.

When the operation mode is repeat, it can be stopped by timer-stop command (74h) or a synchronous action.

2.9.4 Timer and Synchronous Action

Timer operation can be used in a synchronous action.

As the activation factor of a synchronous action, "Timer is up" can be specified. As the action of a synchronous action, there are 3 kinds, "CT \rightarrow MRm (saving the current timer value into MRm register)", "Timer-start" and "Timer-stop" can be specified. For more details of these functions, see chapter 2.6.

2.9.5 Timer Operating State and Current Timer Value Reading

■ Current timer value reading

The current timer value in operation can be read out by current timer value reading command (38h).

A timer counter starts to count up from 0, and the value of a timer counter can be read out anytime during operation.

A timer counter clears to 0 when a timer stops. After a timer is finished or issuing timer-stop command, if the user reads the current timer value, 0 will be read out.

■ Timer operating check

Timer operating state can be checked by D10 bit (TIMER) of RR3 register Page1. When a timer starts, D10 bit (TIMER) becomes 1 and that indicates the timer is in operation.

2.9.6 Interrupt by Timer

The user can generate an interrupt signal when a timer is up. Set D9 bit (TIMER) of WR1 register as 1.

For more details of the interrupt function, see chapter 2.10.

2.9.7 Examples of Timer

■ Example 1 Driving starts after 17.35msec when X axis driving is finished.

When relative position driving is finished, it again starts the same relative position driving after 17.35msec. This is performed by the function of a synchronous action.

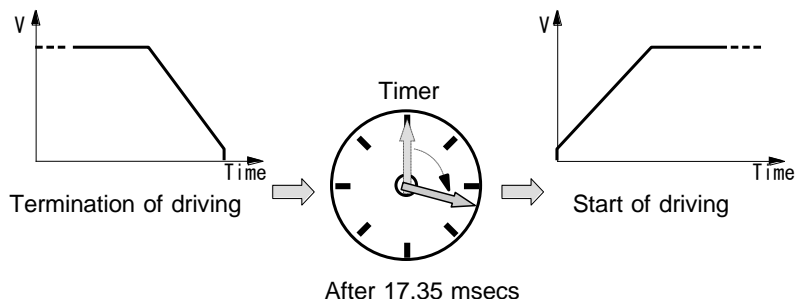

Fig. 2.9-4 Example 1: Timer Operation

【Program Example】

```
// Acceleration / deceleration driving setting
WR6 ← 0190h Write           // Initial speed  400 PPS
WR7 ← 0000h Write
WR0 ← 0104h Write

WR6 ← 9C40h Write           // Drive speed  40K PPS
WR7 ← 0000h Write
WR0 ← 0105h Write

WR6 ← E848h Write           // Acceleration  125K PPS/SEC
WR7 ← 0001h Write
WR0 ← 0102h Write

WR6 ← 9C40h Write           // Drive pulse number  40000
WR7 ← 0000h Write
WR0 ← 0106h Write

// Timer setting
// Single timer
WR0 ← 011Fh Write           // Select X axis
WR3 ← 0000h Write           // D14      0 TMMD :   Timer operation  Once

// Timer value setting
WR6 ← 43C6h Write           // Timer value  17350 μ sec
WR7 ← 0000h Write
WR0 ← 0116h Write

// Synchronous action setting
// Synchronous action SYNC0 setting
WR6 ← 0156h Write           // D3~D0      0110 PRV3~0 : Activation factor  Stops driving
WR0 ← 0126h Write           // D8~D4      10101 ACT4~0 : Action   Timer-start

// Synchronous action SYNC1 setting
WR6 ← 00A2h Write           // D3~D0      0010 PRV3~0 : Activation factor  Timer is up
WR0 ← 0127h Write           // D8~D4      01010 ACT4~0 : Action   Starts relative position driving

// SYNC1~0 Enable
WR0 ← 0183h Write

// Start driving
WR0 ← 0150h Write           // Starts relative position driving
```

■ Example 2 Outputs designated drive pulses to X axis every 1msec.

Relative position driving ($20\text{kpps} \times 10$ pulses of the constant speed drive) starts every 1msec. This is performed by the function of a synchronous action.

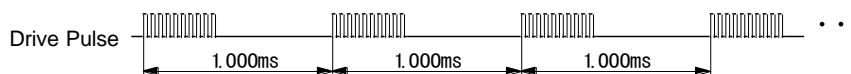

Fig. 2.9-5 Example 2: Timer Operation

【Program Example】

```
// Drive setting (constant speed driving at 1000 PPS)
WR6 ← 1200h Write // Initial speed 8M PPS (maximum in specification)
WR7 ← 007Ah Write
WR0 ← 0104h Write

WR6 ← 4E20h Write // Drive speed 20K PPS
WR7 ← 0000h Write
WR0 ← 0105h Write

WR6 ← 000Ah Write // Drive pulse number 10
WR7 ← 0000h Write
WR0 ← 0106h Write

WR6 ← 0000h Write // Logical position counter 0
WR7 ← 0000h Write
WR0 ← 0109h Write

// Timer setting
// Repeat timer
WR0 ← 011Fh Write // Select X axis
WR3 ← 4000h Write // D14 1 TMMD : Timer operation Repeat

// Timer value setting
WR6 ← 03E8h Write // Timer value 1000 μ sec
WR7 ← 0000h Write
WR0 ← 0116h Write

// Synchronous action setting
// Synchronous action SYNC0 setting
WR6 ← 0153h Write // D3~D0 0011 PRV3~0 : Activation factor Starts driving
// D8~D4 10101 ACT4~0 : Action Timer-start
// D15 0 REP : Repeating action Disabled

WR0 ← 0126h Write

// Synchronous action SYNC1 setting
WR6 ← 80A2h Write // D3~D0 0010 PRV3~0 : Activation factor Timer is up
// D8~D4 01010 ACT4~0 : Action Starts driving
// D15 1 REP : Repeating action Enabled

WR0 ← 0127h Write

// SYNC1~0 Enable
WR0 ← 0183h Write

// Start driving
WR0 ← 0150h Write // Starts relative position driving

.
.
.

// Timer-stop
WR0 ← 0174h Write // Timer-stop

// Disable synchronous action SYNC1
WR0 ← 0192h Write // Disables synchronous action SYNC1
```

■ Example 3 Performs decelerating stop in acceleration/deceleration driving of X axis after driving at constant speed for 10msec.

After acceleration/deceleration driving starts, a timer starts from the start of constant speed area for 10msec and when time is up, it performs decelerating stop. This is performed by the function of a synchronous action.

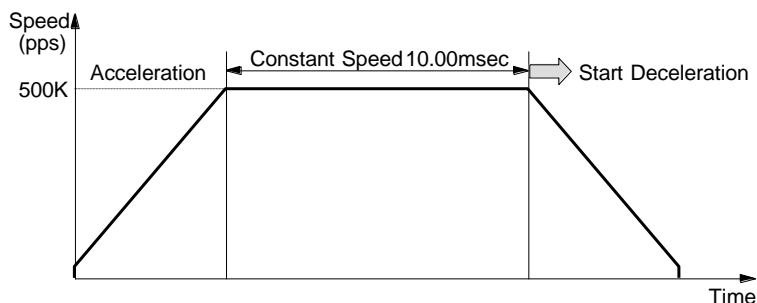

Fig. 2.9-6 Example 3: Timer Operation

【Program Example】

```
// Acceleration / deceleration driving setting
WR6 ← 0064h Write           // Initial speed  100 PPS
WR7 ← 0000h Write
WR0 ← 0104h Write

WR6 ← A120h Write           // Drive speed  500K PPS
WR7 ← 0007h Write
WR0 ← 0105h Write

WR6 ← E848h Write           // Acceleration  125K PPS/SEC
WR7 ← 0001h Write
WR0 ← 0102h Write

// Timer setting
// Single timer
WR0 ← 011Fh Write           // Select X axis
WR3 ← 0000h Write           // D14      0 TMMD :  Timer operation  Once

// Timer value setting
WR6 ← 2710h Write           // Timer value 10000 μ sec
WR7 ← 0000h Write
WR0 ← 0116h Write

// Synchronous action setting
// Synchronous action SYNC0 setting
WR6 ← 0154h Write           // D3~D0    0100 PREV3~0 : Activation factor  Starts driving at constant speed area
WR0 ← 0126h Write           // D8~D4    10101 ACT4~0  : Action    Timer-start

// Synchronous action SYNC1 setting
WR6 ← 0112h Write           // D3~D0    0010 PREV3~0 : Activation factor  Timer is up
WR0 ← 0127h Write           // D8~D4    10001 ACT4~0 : Action    Decelerating stop

// SYNC1~0 Enable
WR0 ← 0183h Write

// Start driving
WR0 ← 0152h Write           // Starts + direction continuous pulse driving
```

2.10 Interrupt

MCX514 has 2 kinds of interruptions, one is the interruption generated from each X, Y, Z and U axis, and the other is the interruption generated during continuous interpolation driving.

The interrupt signal to the host CPU has also 2 signals, INT0N signal generated from each X, Y, Z and U axis, and INT1N signal generated during continuous interpolation driving.

All interrupt factors can be set as enable / disable. At reset, all interrupt signals are disabled.

2.10.1 Interrupt from X, Y, Z and U axes

Factors that generate an interrupt from X, Y, Z and U axes are as follows.

Table 2.10-1 Factors of Interrupt from X, Y, Z and U axes

Enable / Disable WR1 Register	Status RR1 Register	Factors of Interrupt
D0 (CMR0)	D0 (CMR0)	The comparison result of multi-purpose register MR0 with a comparative object changed to meet the comparison condition.
D1 (CMR1)	D1 (CMR1)	The comparison result of multi-purpose register MR1 with a comparative object changed to meet the comparison condition.
D2 (CMR2)	D2 (CMR2)	The comparison result of multi-purpose register MR2 with a comparative object changed to meet the comparison condition.
D3 (CMR3)	D3 (CMR3)	The comparison result of multi-purpose register MR3 with a comparative object changed to meet the comparison condition.
D4(D-STA)	D4(D-STA)	Driving starts.
D5(C-STA)	D5(C-STA)	Pulse output starts at constant speed area in acceleration / deceleration driving.
D6(C-END)	D6(C-END)	Pulse output is finished at constant speed area in acceleration / deceleration driving.
D7(D-END)	D7(D-END)	Driving is finished.
D8(H-END)	D8(H-END)	Automatic home search is finished.
D9(TIMER)	D9(TIMER)	Timer expires.
D10(SPLTP)		Outputs split pulse. (in positive logic, occurs at ↑ of split pulse)
D11(SPLTE)		Split pulse is finished.
D12(SYNC0)		Synchronous action SYNC0 is activated.
D13(SYNC1)		Synchronous action SYNC1 is activated.
D14(SYNC2)		Synchronous action SYNC2 is activated.
D15(SYNC3)		Synchronous action SYNC3 is activated.

■ Interrupt setting and reading

Each factor of interrupt can be set by setting levels in WR1 register bits: 1- enable and 0 - disable as shown in the table above. When the interrupt factor that is enabled becomes True, the corresponding bit of RR1 register will be set as 1 and the interrupt output signal (INT0N) will be on the Low level. After the RR1 status has been read from the host CPU, RR1 register will be cleared from 1 to 0 and INT0N will return to the Hi-Z level. That is, the interrupt signal is automatically cleared by reading RR1 register. And the information that an interrupt occurred is sent to the CPU only once by the first reading of RR1 register after the interrupt, and after that, if the user reads RR1 register, the bit indicates 0 unless the next interrupt factor becomes True (Read-reset method).

■ Multiple interrupts

When multiple interrupt factors are enabled, if the first interrupt factor becomes True, the signal (INT0N) will be on the Low and the corresponding bit of RR1 register will be set as 1. After that, if the other factor becomes True before the CPU reads RR1 register, the bit corresponding to the other factor will be set as 1. In this case when reading RR1 register, two or more bits indicate 1 and the each interrupt factor notifies the occurrence of it.

■ Interrupt in 8-bit data bus

When 8-bit data bus is used, individually set 1– enable or 0 – disable to each WR1H/WR1L register. When an interrupt occurs (interrupt signal (INT0N) is Low), individually read each RR1H/ RR1L register. If either register is only enabled, there is no need to read another register. The bits that indicate an interrupt are cleared to 0 by reading RR1H register once and RR1L register is the same as RR1H. When all the bits of both registers are cleared, the interrupt signal (INT0N) returns to the Hi-Z level.

■ Interrupt in I²C serial interface bus

When I²C serial interface bus is used, individually set 1– enable or 0 – disable to each WR1H/WR1L register. In addition, it can be set 1– enable or 0 – disable by WR1 registers at once. When an interrupt occurs (interrupt signal (INT0N) is Low), read RR1 registers. Even though either register is only enabled, be sure to read 2 bytes (RR1L, RR1H). When RR1 register is read out, the bits that indicate an interrupt are cleared to 0 and the interrupt signal (INT0N) returns to the Hi-Z level.

For more details of I²C serial interface bus, see chapter 4, details of WR1 register, see chapter 6.5 and details of RR1 register, see chapter 6.12

Notes on the read timing from CPU

The timing of read/write cycles from the CPU is shown in chapter 10.2.2. In read cycle, the address signal A[3:0] must be determined in the section of RDN signal is Low level. tAR minimum is 0 and tRA minimum is 3nsec. If this condition is violated and non-valid address data is into the section of RDN signal is Low level, the data of RR1 register will be cleared by reading the other register and the interrupt signal (INT0N) may be cleared. Please note the read timing from the CPU when using the interrupt signal (INT0N).

2.10.2 Interrupt during Continuous Interpolation

It sets 1– enable or 0 – disable by interpolation mode setting command (2Ah). When the interrupt factor that is enabled becomes True, interpolation interrupt output signal (INT1N) becomes Low level.

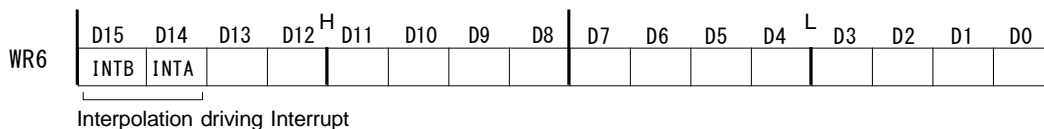

Table 2.10-2 Interrupt Factor generated in Continuous Interpolation

Enable / Disable Interpolation Mode	Factors of Interrupt
D14 (INTA)	Stack counter in pre buffer changed from 4 to 3.
D15 (INTB)	Stack counter in pre buffer changed from 8 to 7.

Interpolation interrupt output signal (INT1N) is cleared and returns to the Hi-Z level by the following condition.

- ① Interpolation interrupt clear command (6Fh) is written.
- ② Interpolation execution command of next segment is written.
- ③ Continuous interpolation driving is finished.

When both interrupt factors are enabled, if the first interrupt factor becomes True, interpolation interrupt output signal (INT1N) will be on the Low level. After that, if the other interrupt factor becomes True before clearing, interpolation interrupt output signal (INT1N) keeps the Low level. And if they are cleared, interpolation interrupt output signal (INT1N) returns to the Hi-Z level.

2.11 Input Signal Filter

This IC is equipped with an integral type filter in the input stage of each input signal. Figure 2.11-1 shows the filter configuration of each input signal in X axis, and Y, Z and U axes have the same circuit as X axis. The time constant of a filter is determined by the T oscillation circuit in the diagram. This IC has two time constants A and B, and it is determined by the kind of an input signal which of the time constants A or B is used. Enable/disable of a filter and a time constant can be set by input signal filter mode setting command (25h).

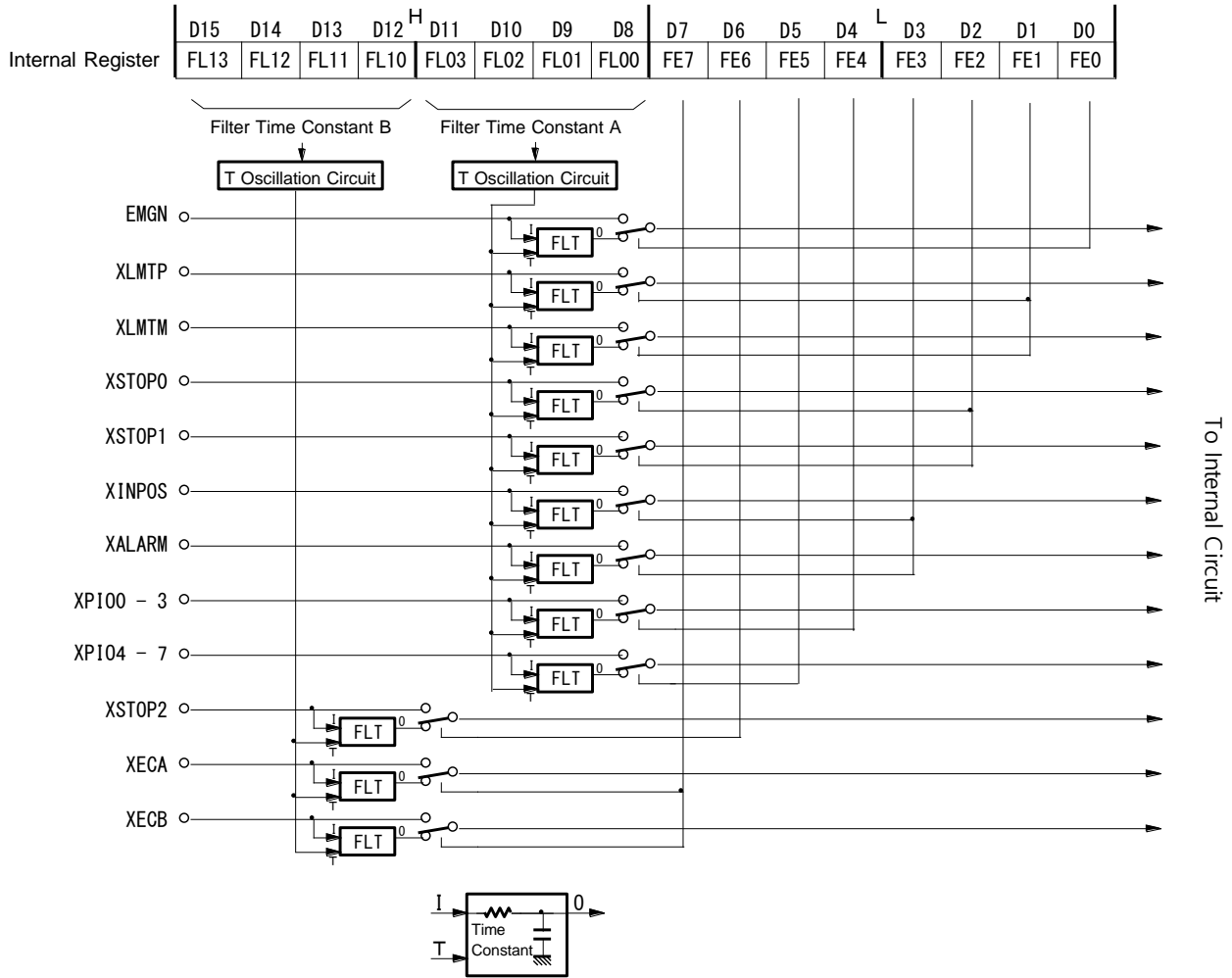
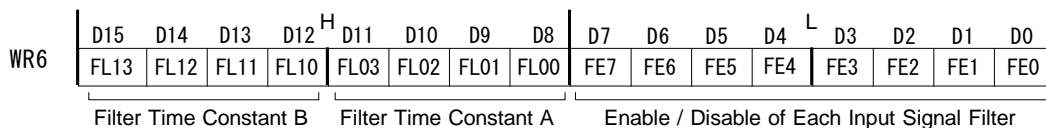

Fig. 2.11-1 Concept of X axis Input Signal Filter Circuit

2.11.1 Setting of Input Signal Filter Function

The filter function of each input signal can be set by input signal filter mode setting command (25h).



The user can set whether the IC built-in filter function is enabled or the signal is passed through, to D7~0 bits (FE7~FE0) of each input signal. Set 1 to enable the filter function and 0 to disable (through).

Input signals corresponding to each bit is shown in the table 2.11-1. The time constant A or B applied to each input signal is determined.

Table 2.11-1 Input Signal and Corresponding Time Constant

Specified bit	Input signal	Applied time constant
D0(FE0)	EMGN *	Filter Time Constant A
D1(FE1)	nLMTP, nLMTM	
D2(FE2)	nSTOP0, nSTOP1	
D3(FE3)	nINPOS, nALARM	
D4(FE4)	nPIO3~0	
D5(FE5)	nPIO7~4	Filter Time Constant B
D6(FE6)	nSTOP2	
D7(FE7)	nECA, nECB	

*Note: EMGN signal is set to D0 bit of WR6 register of X-axis.

Use D11~ D 8 bits (FL03~FL00) for setting the filter time constant A and D15~D12 bits (FL13~FL10) for setting the filter time constant B.

Select a filter time constant from 16 stages shown in the table 2.11-2. When a time constant is increased, the removable maximum noise width increases, however, the signal delay time also increases. Therefore, set an appropriate value. Normally, set Ah or Bh for the time constant A. The time constant B (FL13~10) is provided for an encoder input signal.

Table 2.11-2 Time Constant and Removable Maximum Noise Width

(CLK=16MHz)		
Time constant (Hex)	Removable maximum noise width* 1	Input signal delay time
0	437.5nsec	500nsec
1	875nsec	1μsec
2	1.75μsec	2μsec
3	3.5μsec	4μsec
4	7μsec	8μsec
5	14μsec	16μsec
6	28μsec	32μsec
7	56μsec	64μsec
8	112μsec	128μsec
9	224μsec	256μsec
A	448μsec	512μsec
B	896μsec	1.024msec
C	1.792msec	2.048msec
D	3.584msec	4.096msec
E	7.168msec	8.192msec
F	14.336msec	16.384msec

*1: Noise width

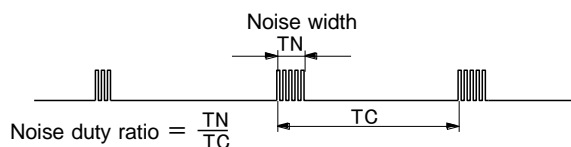

It requires that the noise duty ratio (time ratio under which noise is generated in the signal) must be 1/4 or less.

At reset, all input signal filter functions are disabled (through).

Filter functions are not available for input signals EXPLSN, PIN7~0.

2.11.2 Example of Setting Input Signal Filters

For the input signals belong to the filter time constant A, set a 128 μ sec delay filter to EMGN, XLMTP, XLMTM, XSTOP0, XSTOP1 input signals and set “through” to other input signals.

XECA, XECB, XSTOP2 input signals belong to the filter time constant B are “through”.

【Program Example】

```
// Input/output signal filter mode setting
WR6 ← 0807h Write // D15~D12 0000 Filter time constant B Filter delay:500nsec
                  // D11~D8  1000 Filter time constant A Filter delay:128 $\mu$ sec
                  // D7     0 XECA, XECB signal (Filter time constant B) : Disables the filter (through)
                  // D6     0 XSTOP2 signal (Filter time constant B) : Disables the filter (through)
                  // D5     0 XPI04-7 signal (Filter time constant A) : Disables the filter (through)
                  // D4     0 XPI00-3 signal (Filter time constant A) : Disables the filter (through)
                  // D3     0 XINPOS, XALARM signal (Filter time constant A) : Disables the filter
(through)
                  // D2     1 XSTOP0,1 signal (Filter time constant A) : Enables the filter
                  // D1     1 XLMTP, XLMTM signal (Filter time constant A) : Enables the filter
                  // D0     1 EMGN signal (Filter time constant A) : Enables the filter
WR0 ← 0125h Write
```

2.12 Other Functions

2.12.1 Driving By External Pulses

This function is that controls relative position driving and continuous pulse driving not by the commands but by external signals. (nEXPP, nEXPM). As the number of motor axis controlled by the system increases, there is a possibility that the CPU cannot handle manual operations appropriately such as JOG feed or teaching mode due to the CPU load. This IC can reduce the host CPU load using driving by external pulses. And by inputting an encoder 2-phase signal of a manual pulsar, jog feed will be enabled.

nPIO4, 5 signals of general purpose input/output signals are assigned to nEXPP, nEXPM signals.

To perform driving by external signals, the following items must be set.

- ① Set nPIO4, 5 signals to the input by PIO signal setting 1 command (21h).
- ② Set the driving mode by PIO signal setting 2 • Other settings (22h).

■ Function Setting for Driving by External Signals of nPIOm Signal

To perform driving by external signals, set nPIO4, 5 signals of general purpose input/output signals to nEXPP, nEXPM input signals for driving by external pulses.

It sets D11~8 bits of PIO signal setting 1 command (21h).

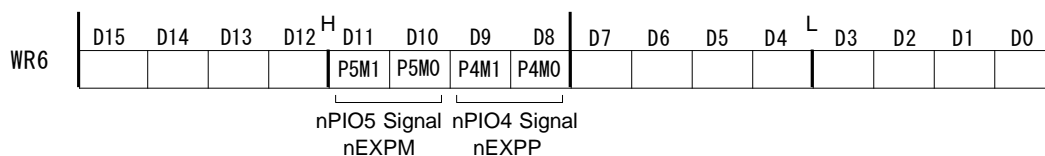

To use the function of nPIO4 signal as the input signal for driving by external pulses (nEXPP), set 0, 0 to D9, 8 bits. Similarly, set 0, 0 to D11, 10 bits of nPIO5 signal.

■ Mode setting for driving

This is the mode setting for driving by external pulses. It sets D9, 8 bits of PIO signal setting 2 • Other settings (22h).

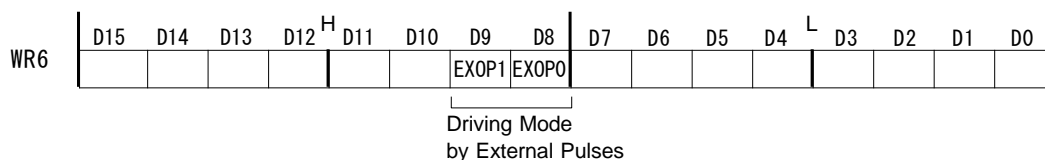

Use 2 bits, D9, 8 bits to set the mode of driving by external signals (nEXPP, nEXPM).

The driving mode corresponding to each bit is shown in the table below.

Table 2.12-1 Mode of Driving by External Signals

D9(EXOP1)	D8(EXOP0)	Mode of driving by external signals
0	0	Disables the driving by external signals
0	1	Continuous pulse driving mode
1	0	Relative position driving mode
1	1	Manual pulsar mode

■ Relative position driving mode

Set 1, 0 to D9, 8 bits of PIO signal setting 2 • Other settings (22h) and set the appropriate speed parameters for relative position driving and drive pulse number (positive value). Once nEXPP falls down to the Low level (↓), + direction relative position driving will start by ↓ of it. Similarly, once nEXPM falls down to the Low level (↓), - direction relative position driving will start by ↓ of it. The Low level width of each signal must be larger than 4 CLK cycles. Before the driving is finished, if the signal falls down from the Hi to Low level again, it will be invalid.

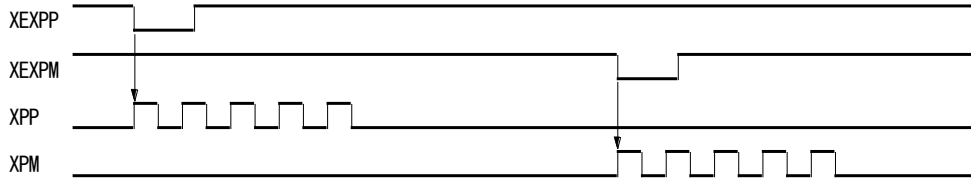

Fig. 2.12-1 Example of X axis Relative Position Driving (Drive Pulse Number: 5) by External Signal

■ Continuous Pulse Driving Mode

Set 0, 1 to D9, 8 bits of PIO signal setting 2 • Other settings (22h) and set the appropriate speed parameters for continuous pulse driving. Once nEXPP falls down to the Low level (↓), the + direction driving pulses will be output continuously during the low level. If nEXPP returns from Low level to Hi level, decelerating stop will be performed in trapezoidal driving and instant stop will be performed in constant speed driving. Similarly, nEXPM will output the - direction driving pulses continuously during the low level. If the other input signal of nEXPP/nEXPM signals falls down from the Hi to Low level, the driving in the other direction will start immediately after the driving in the current direction is finished.

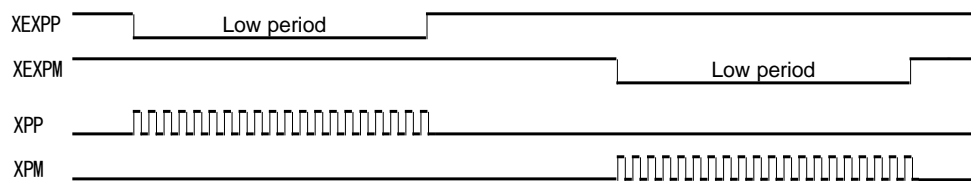

Fig. 2.12-2 Example of X axis Continuous Pulse Driving by External Signal

■ Manual pulsar mode

Set 1, 1 to D9, 8 bits of PIO signal setting 2 · Other settings (22h) and set the appropriate speed parameters for driving and drive pulse number. Connect the A-phase signal of an encoder to nEXPP input and the B-phase signal to nEXPM input. When nEXPM signal is on the Low level, +direction relative position driving is activated at the rising edge ↑ of nEXPP signal. When nEXPM signal is on the Hi level, -direction relative position driving is activated at the rising edge ↑ of nEXPP signal. When the drive pulse number is set as 1, one drive pulse is output at the each rising edge ↑ of nEXPP signal. If drive pulse number is set as TP, the TP number of drive pulses is output.

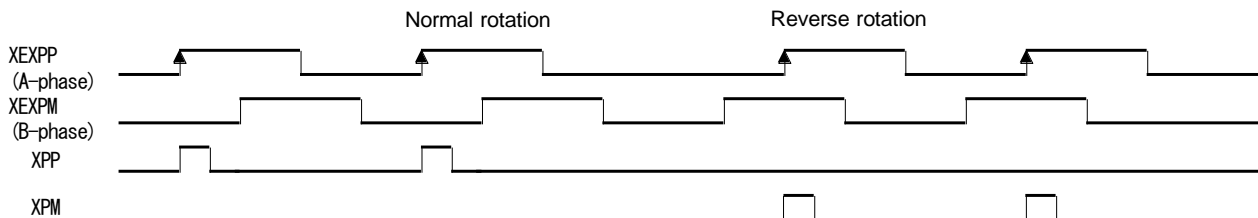

Fig. 2.12-3 Example of X axis Driving (Drive Pulse Number: 1) by Manual pulsar

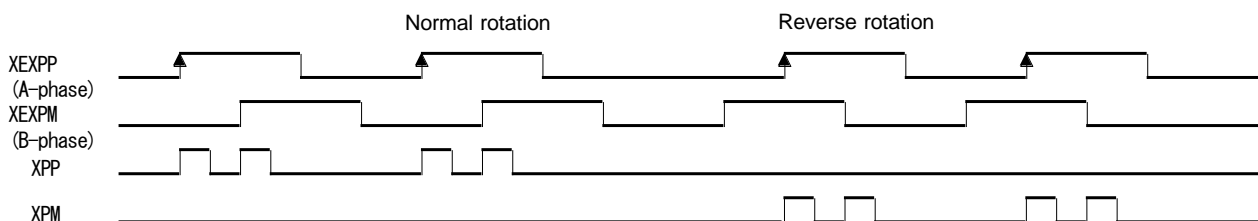

Fig. 2.12-4 Example of X axis Driving (Drive Pulse Number: 2) by Manual pulsar

Set the speed parameter in the following conditions to complete output of the TP number of drive pulses with a period from the rising edge ↑ of nEXPP signal to the next rising edge ↑ of nEXPP signal.

$$DV \geq F \times TP \times 2$$

- DV : Drive speed (pps)
- TP : Drive pulse number
- F : Frequency (Hz) at the maximum speed of the manual pulsar encoder

For instance, under the conditions where the maximum frequency of the manual pulsar is F=500Hz and the drive pulse number is TP =1, the drive speed must be DV=1000pps or greater. Since acceleration/deceleration driving is not applied, set the initial speed SV larger than the drive speed DV. However, when a stepping motor is used for driving, the drive speed must not exceed the self-starting frequency of the motor.

2.12.2 Pulse Output Type Selection

Drive pulse output signals are XPP/PLS/PA(37) and XPM/DIR/PB(38) in X axis, YPP/PLS/PA (39) and YPM/DIR/PB(40) in Y axis, ZPP/PLS/PA (41) and ZPM/DIR/PB(42) in Z axis, and UPP/PLS/PA (43) and UPM/DIR/PB(44) in U axis. Four pulse output types are available to each axis as shown in the table below. In independent 2-pulse type, when the driving is in the + direction, the pulse output is from nPP, and when the driving is in the - direction, the pulse output is from nPM. In 1-pulse 1- direction type, nPLS is for output of drive pulses and nDIR is for output of direction signals. In quadrature pulse type, the A-phase signal of quadrature pulse is output to nPA and the B-phase signal of quadrature pulse is output to nPB. In quadrature pulse and quad edge evaluation, when output of nPA, nPB pulses changes, the logical position counter is up (down). In quadrature pulse and double edge evaluation, when output of nPA pulses changes, the logical position counter is up (down).

Table 2.12-2 Example of X axis Drive Pulse Output Type

Pulse Output Type	Signal	Driving in the + direction					Driving in the - direction					
		LP	0	1	2	3	4	4	3	2	1	0
Independent 2-pulse	XPP		High	Low	High	Low	High	Low	High	Low	High	Low
	XPM		Low	High	Low	High	Low	High	Low	High	Low	High
1-pulse 1-direction	XPLS		High	Low	High	Low	High	Low	High	Low	High	Low
	XDIR		Low	High	Low	High	Low	High	Low	High	Low	High
Quadrature pulses and quad edge evaluation	XPA		High	Low	High	Low	High	Low	High	Low	High	Low
	XPB		Low	High	Low	High	Low	High	Low	High	Low	High
Quadrature pulses and double edge evaluation	XPA		High	Low	High	Low	High	Low	High	Low	High	Low
	XPB		Low	High	Low	High	Low	High	Low	High	Low	High

Pulse output type can be set by D4, 3 bits (DPMD1, 0) of WR3 register.

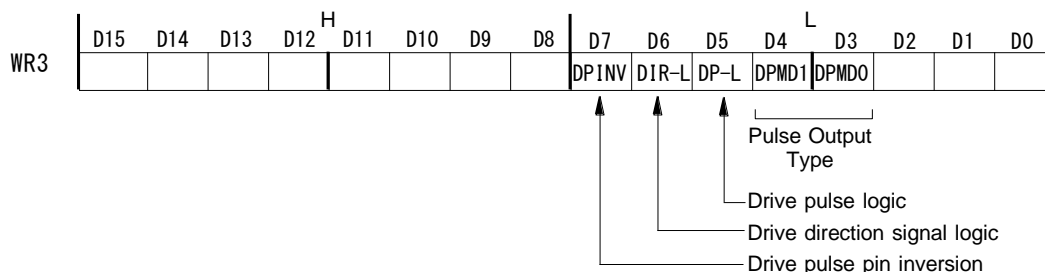

The mode setting for driving corresponding to each bit is as follows.

Table 2.12-3 Drive Pulse Output Type

D4(DPMD1)	D3(DPMD0)	Pulse Output Type
0	0	Independent 2-pulse
0	1	1-pulse 1-direction
1	0	Quadrature pulse and quad edge evaluation
1	1	Quadrature pulse and double edge evaluation

Please refer to chapter 11.2 for the timing of output pulse signal (nPLS) and direction signal (nDIR) in 1-pulse 1-direction type. When the user wants to set nDIR signal before driving, write direction signal + setting command (58h) or direction signal - setting command (59h).

And it sets the logical level of driving pulses by D5 bit (DP-L), the logical level of the direction (DIR) output signal by D6 bit (DIR-L) and sets whether the output pins of a drive pulse signal are replaced or not by D7 bit (DPINV).

[Note]

- In interpolation driving, the direction changes on the way, therefore, use independent 2-pulse type for interpolation driving and not 1-pulse 1-direction type.

2.12.3 Encoder Pulse Input Type Selection

The encoder pulse input (nECA /PPIN, nECB /PMIN) which counts up/down the real position counter can be selected from 2 types, quadrature pulses input and Up / Down pulse input.

■ Quadrature pulses input

As quadrature pulses input types, the user can select from 3 types, quadrature pulses input and quad edge evaluation, quadrature pulses input and double edge evaluation, quadrature pulses input and single edge evaluation.

When quadrature pulses input type is engaged and ECA signal goes faster 90 degree phase than ECB signal does, it's "count up" and ECB signal goes faster 90 degree phase than ECA signal does, it's "count down". And when quad edge evaluation is set, it counts Up/Down at the rising edge (↑) and falling edge (↓) of both signals. When double edge evaluation is set, it counts Up/Down at the rising edge (↑) and falling edge (↓) of A-phase signals. When single edge evaluation is set, it counts Up/Down at the rising edge (↑) of A-phase signals.

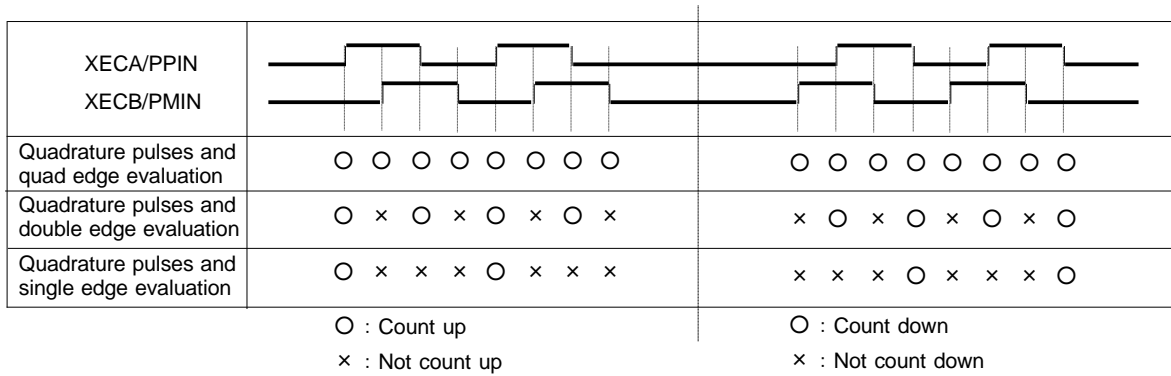

Fig. 2.12-5 Example of X axis Quadrature Pulse Input

■ Up/down pulse input

nECA /PPIN is for "count up" input, and nECB /PMIN is for "count down" input. The counter counts up when the positive pulses go up (↑). (when the positive logic is set.)

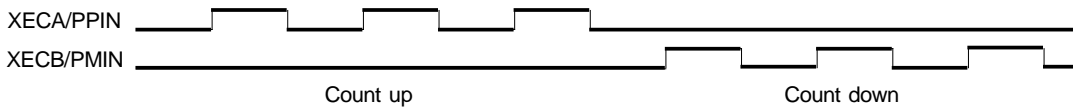
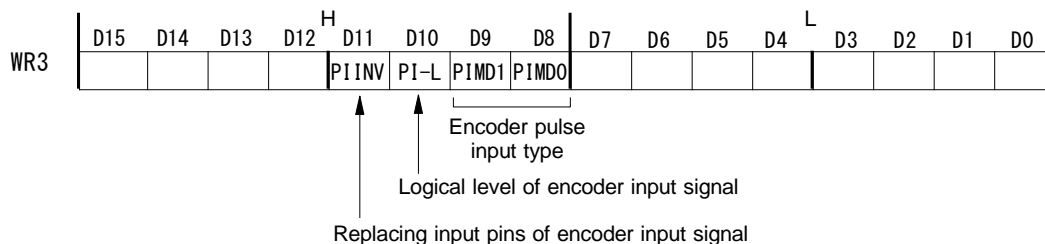

Fig. 2.12-6 Example of X axis Up / Down Pulse Input

Encoder Pulse Input Type Setting

Encoder pulse input type can be set by D8, 9 bits (PIMD0, 1) of WR3 register.



The encoder pulse input type corresponding to each bit is as follows.

Table 2.12-4 Encoder pulse input type

D9(PIMD1)	D8(PIMD0)	Encoder pulse input type
0	0	Quadrature pulses input and quad edge evaluation
0	1	Quadrature pulses input and double edge evaluation
1	0	Quadrature pulses input and single edge evaluation
1	1	Up / Down pulse input

And it sets the logical level of an encoder input signal by D10 bit (PI-L) and sets whether the input pins of an encoder pulse input are replaced or not by D11 bit (PIINV).

The increase/decrease of the real position counter due to replacing input pins of an encoder input signal as shown in the table below.

Table 2.12-5 Increase/Decrease of Real Position Counter due to Replacing Input Pins of Encoder Input Signal

WR3/D11(PIINV)	Pulse input mode	Increase/decrease of real position counter
0	quadrature pulses mode	Count UP when the A phase is advancing. Count DOWN when the B phase is advancing.
	Up / Down pulse mode	Count UP at nPPIN pulse input. Count DOWN at nPMIN pulse input.
1	quadrature pulses mode	Count UP when the B phase is advancing. Count DOWN when the A phase is advancing.
	Up / Down pulse mode	Count UP at nPMIN pulse input. Count DOWN at nPPIN pulse input.

2.12.4 Hardware Limit Signals

Hardware limit signals, nLMTP and nLMTM, are used for stopping the pulse output if the limit sensors of + and - directions are triggered.

The user can set to enable/disable a limit signal and set the logical level of a limit signal, and set whether to perform decelerating stop or instant stop when a limit signal becomes active, and select whether to replace input pins of hardware limit input signals.

Enable/disable of a limit signal, the logical level of a limit signal and the stop type can be set by D12~10 bits of WR2 register. For more details of the WR2 register, see chapter 6.6.

Whether to replace input pins of hardware limit input signals or not can be set by D12 bit (LMINV) of WR3 register. For more details of the WR3 register, see chapter 6.7.

The status of a limit signal can be read out from RR3 register Page0 anytime.

2.12.5 Interface to Servo Motor Driver

■ nINPOS signal and nALARM signal

As the input signals for connecting a servo motor driver, there are the nINPOS signal (in-position input signal) and the nALARM signal (alarm input signal).

The user can set each signal to enable/disable and the logical level by D9~6 bits of WR2 register. For more details of the WR2 register, see chapter 6.6.

nINPOS input signal responds to the in-position signal of a servo motor driver. When setting as enable, and if nINPOS becomes active after driving is finished, D3~0 bits (n-DRV: Driving status) of RR0 (main status) register will return to 0.

nALARM input signal receives the alarm signal from a servo motor driver. When setting as enable, it monitors nALARM signal during the driving, and when nALARM becomes active, driving will stop instantly. At this time, D4 (ALARM) and D14 (ALARM) bits of RR2 register become 1.

The status of these input signals from a servo motor driver can be read out from RR3 register Page0 anytime.

■ Deviation counter clear output signal

A Deviation counter clear signal (nDCC) is available as a servo motor driver output signal.

The logical level of a deviation counter clear signal (nDCC) and pulse width can be set by D3~6 bits of automatic home search mode setting 2 command (24h). For more details of the automatic home search mode setting 2 command (24h), see chapter 7.3.5.

When deviation counter clear output command (72h) is written, deviation counter clear pulses are output based on the logical level of pulses and pulse width set by automatic home search mode setting 2 command (24h).

In the case of using the deviation counter clear signal (nDCC) in automatic home search, see chapter 2.5.2 and 2.5.4.

2.12.6 Emergency Stop

MCX514 has the input signal EMGN that can perform the emergency stop function during the driving of all 4 axes. Normally, this signal is kept on the Hi level. When it falls down to the Low level, all axes which drive will stop immediately and D5 (EMG) and D15 (EMG) bits of RR2 register become 1. Please note that there is no way to select the logical level of EMGN signal.

There are the following methods to perform the emergency stop to function for 4 axes from the host CPU.

- a. Write an instant stop command to 4 axes
Specify all 4 axes to WR0 register and then write instant stop command (57h).
- b. Write a command reset
Write 00FFh into WR0 register, and it will be reset.

2.12.7 Status Output

The status of driving /stop is output to D3~0 (n-DRV) bits of RR0 register and nPIO0 signal.

The driving status of acceleration / constant speed / deceleration is output to D4(ASND), D5(CNST), D6(DSND) bits of RR3 register Page1 in each axis, and also the signals nPIO2/ASND, nPIO3/CNST, nPIO4/DSND show the levels.

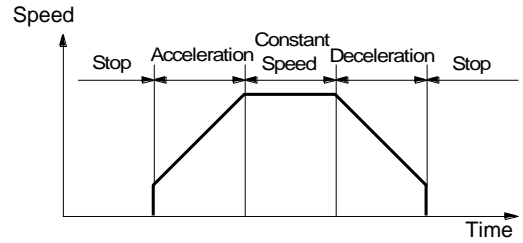

Fig. 2.12-7 Driving Status

Table 2.12-6 RR0, RR3 registers and nPIOm signal corresponding to Driving Status

Drive Status	RR0 register	RR3 register Page1			nPIOm signal			
	D3~0(n-DRV)	D4/ASND	D5/CNST	D6/DSND	nPIO0/DRIVE	nPIO2/ASND	nPIO3/CNST	nPIO4/DSND
Stop	0	0	0	0	Low	Low	Low	Low
Acceleration	1	1	0	0	Hi	Hi	Low	Low
Constant Speed	1	0	1	0	Hi	Low	Hi	Low
Deceleration	1	0	0	1	Hi	Low	Low	Hi

In S-curve acceleration/deceleration driving, the status of acceleration increasing / acceleration constant / acceleration decreasing is output to D7(AASND), D8(ACNST), D9(ADSND) bits of RR3 register Page1 in each axis and nPIO5/AASND, nPIO6/ACNST, nPIO7/ADSND signals.

To output the driving status to nPIOm signal, use PIO signal setting 1 command (21h). See chapter 7.3.2

3. Interpolation

Interpolation driving is the operation to move the position by interpolating every drive pulse each of more than 2axes.

MCX514 can perform linear interpolation, circular interpolation, helical interpolation and bit pattern interpolation driving, selecting an arbitrary axis of 4 axes. In addition, multiple axes linear interpolation of more than 5 axes can be performed by using several these ICs.

The basic operation procedures to perform interpolation are as follows.

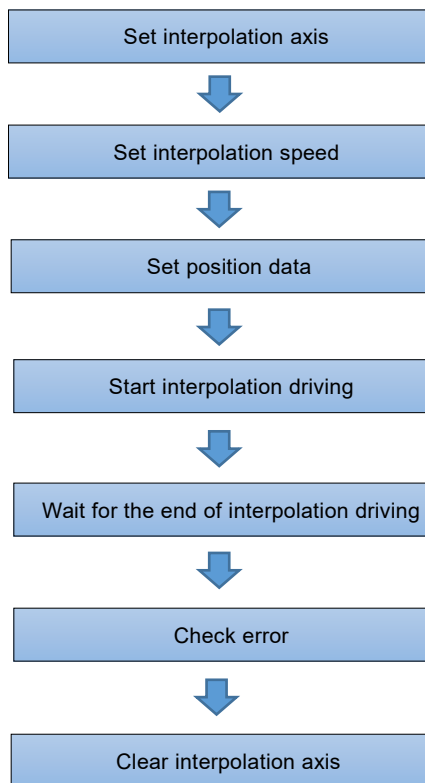

Set interpolation axis

Select the axis to perform interpolation using interpolation mode setting command (2Ah).

For more details of interpolation mode setting command (2Ah), see chapter 7.3.8.

[Note]

- Axis assignment for interpolation (issuing interpolation mode setting command (2Ah)) must be performed at the first of interpolation settings. If assigned after interpolation speed or position data settings, interpolation driving will not be performed correctly.

Set interpolation speed

Set the speed for interpolation driving, which should be set to the main axis that is automatically determined in order of priority X>Y>Z>U from selected axes. For instance, when X, Z and U axes are assigned as the interpolation axis, the main axis is X axis, and the user sets speed parameters such as initial speed and drive speed to the main axis. The main axis outputs main axis pulse to the interpolation counting section when interpolation driving starts. In the interpolation counting section, the calculation cycle is performed at the timing of main axis pulse, and drive pulses are generated for each interpolation axis. Please refer to Fig. 1.2-1 MCX514 The Whole Functional Block Diagram. As the main axis pulse works only in the interpolation counting section, so the drive pulse of the main axis does not become the setting speed.

The maximum drive speed of each interpolation driving is as follows.

Interpolation	Maximum Drive Speed
Linear interpolation	8Mpps
Circular interpolation	8Mpps
Bit pattern interpolation	4Mpps
Helical interpolation	250Kpps

Be sure to set interpolation speed when interpolation driving is performed, especially in the following cases, it must be set.

- When interpolation driving is performed after normal driving, and when speed parameters are the same as those in normal driving.
- After interpolation driving, when interpolation driving is performed without changing speed and position parameters but interpolation mode setting is changed.

Speed changing during interpolation driving

Speed can be changed during interpolation driving by synchronous action. Set drive speed that the user wants to change to multi-purpose register. For synchronous action, see chapter 2.6.

[Note]

- When short axis pulse equalization mode is set, set 8 times speed value of which the user wants to operate. For instance, if the user wants to operate at 1,000pps, set "8,000". Speed value can be set within the range of "1~8,000,000".

Set position data

In 2, 3, 4 axes linear interpolation, set the finish point of each axis, and in circular interpolation, set the center and finish points of a circular arc. In 2, 3, 4 axes bit pattern interpolation, set the bit data in the $+/-$ direction of each axis. In bit pattern interpolation, the user can write 128 bit data to each axis before interpolation driving starts. In helical interpolation, set the center and finish points of a circular arc and moving distance in the Z and U direction.

[Note]

- Even though interpolation driving that has the same position data is performed continuously, be sure to set position data.

Start interpolation driving

After necessary speed and position parameters for interpolation are set, if interpolation driving command is written, interpolation driving will start. In bit pattern interpolation, the user can infinitely draw an arbitrary drive locus continuously by filling bit data during interpolation driving.

Wait for termination of interpolation driving

During interpolation driving, n-DRV bits of all axes that perform RR0 (main status register) interpolation become 1. And after interpolation driving is finished, the bits return to 0.

Error check

During interpolation driving, hardware and software limit error works in each driving axis. When the limit of any axis becomes active during interpolation driving, the interpolation stops. If stopped by an error, the error bit of the axis designated in interpolation in RR0 (main status register) will become 1. If the bit is 1, the user can identify the cause of the error by reading RR2 (error register) of the axis.

[Note]

- In circular, helical and bit pattern interpolation, the hardware or software limit of either $+/-$ direction becomes active, the interpolation may stop. In this case, the user cannot escape from the limit area by circular, helical and bit pattern interpolation. Please escape it by driving the axis alone.

Clear axis assignment of interpolation

When interpolation driving is finished, be sure to clear the axis assignment of interpolation by using interpolation mode setting command (2Ah). If normal driving is performed with the axis assignment of interpolation, driving may not be performed correctly.

■ In-position Signal for Servo Motor

During interpolation driving, in case of the in-position signal (nINPOS) of each axis being enabled, nINPOS signals of all axes become active after interpolation driving is finished, and then the drive bits of all axes that perform RR0 (main status register) interpolation return to 0.

■ Stop of interpolation driving by synchronous action

When interpolation driving is stopped by synchronous action, be sure to write error/finishing status clear command (79h) to the interpolation axis after checking that interpolation drive stops. The user can check the termination of driving by synchronous action, by using D8 bit of RR2 register.

For more details of synchronous action, see chapter 2.6, and details of RR2 register, see chapter 6.13.

■ Interpolation driving after driving stops by nSTOP0, nSTOP1 or nSTOP2 signal

When interpolation driving is performed by using the stopped axis after the driving except interpolation is stopped by nSTOP0, nSTOP1 or nSTOP2 signal, be sure to write error/finishing status clear command (79h) to the interpolation axis. The user can check the termination of driving by RR2 register. For more details of RR2 register, see chapter 6.13.

3.1 Linear Interpolation

Any 2 or 3 axes or all the 4 axes can be set for linear interpolation.

To execute linear interpolation, set the finish point coordinates relative to the present point coordinates, and write the linear interpolation driving command based on the number of interpolation axis, then linear interpolation will be performed.

The finish point coordinates should be set to output pulse number of each axis by the relative value to the present point coordinates.

Fig. 3.1-1 shows an example of 2-axis interpolation where linear interpolation is performed from the current coordinates to the finish point coordinates. As shown in the figure, the calculation accuracy of position to the ideal line is within ± 0.5 LSB.

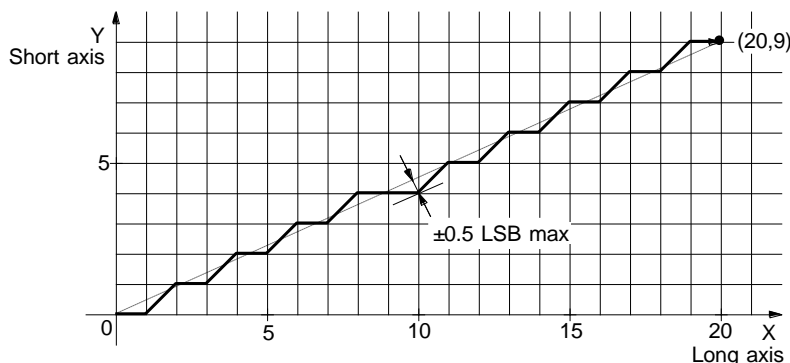

Fig. 3.1-1 Position Accuracy for Linear Interpolation

As shown in Fig. 3.1-2, it is an example for pulse output of the linear interpolation driving. We define the longest distance movement in interpolation is the “long axis”.

And the other is “short axis”. The long axis outputs an average pulse train. The driving pulse of the short axis depends on the long axis and the relationship of the two axes.

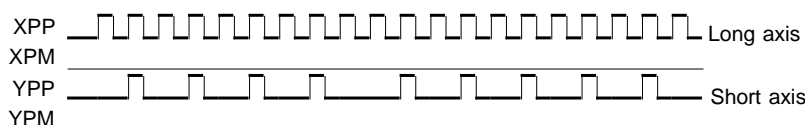

Fig. 3.1-2 Example of Pulse Output at Finish Point (X=20, Y=9)

When constant vector speed mode is disabled, the speed of the drive pulse in long axis becomes the drive speed for the main axis.

The range for each axis is a 31-bit signed counter, from -1,073,741,823 ~ +1,073,741,823 (signed 31-bit-2LSB).

3.1.1 Maximum Finish Point

The absolute value of the finish point in long axis is called the maximum finish point.

At the reset initial state of IC, the maximum finish point is automatically calculated, but the user can set it manually by interpolation mode setting command (2Ah). If in manual setting, the user can specify the arbitrary value as the maximum finish point. For more details of interpolation mode setting command (2Ah), see chapter 7.3.8.

3.1.2 Examples of Linear Interpolation

■ Example of linear interpolation for 2 axes

Executes linear interpolation in X and Y axes from the current position to the finish position (X: +300, Y: -200). The interpolation drive speed is constant: 1000PPS.

```

WR6 ← 0003h Write ; map interpolation axis X, Y
WR0 ← 002Ah Write

WR6 ← 03E8h Write ; initial speed : 1000 PPS
WR7 ← 0000h Write
WR0 ← 0104h Write

WR6 ← 03E8h Write ; drive speed : 1000 PPS
WR7 ← 0000h Write
WR0 ← 0105h Write

WR6 ← 012Ch Write ; finish point of X axis : 300
WR7 ← 0000h Write
    
```

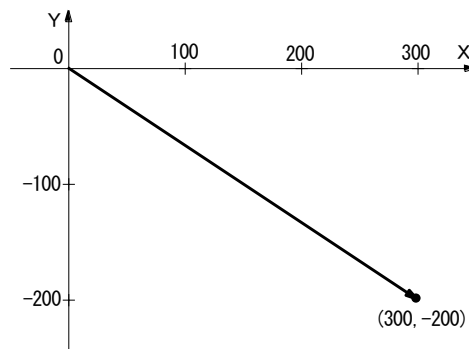

```

WR0 ← 0106h Write
WR6 ← FF38h Write ; finish point of Y axis : -200
WR7 ← FFFFh Write
WR0 ← 0206h Write
WR0 ← 0061h Write ; 2-axis linear interpolation driving

```

■ Example of linear interpolation for 3 axes

Executes linear interpolation for X, Y and Z axes from the current position to the finish position (X: 15,000, Y: 16,000, Z: 20,000). The initial speed = 500PPS, acceleration / deceleration = 40,000PPS/SEC, drive speed = 5,000PPS.

```

WR6 ← 0007h Write ; map interpolation axis X, Y, Z
WR0 ← 002Ah Write
WR6 ← 9C40h Write ; 40,000 PPS/SEC
WR7 ← 0000h Write
WR0 ← 0102h Write ; set accel. speed to main axis
WR6 ← 01F4h Write ; 500 PPS
WR7 ← 0000h Write
WR0 ← 0104h Write ; set initial speed to main axis
WR6 ← 1388h Write ; 5000 PPS
WR7 ← 0000h Write
WR0 ← 0105h Write ; set drive speed to main axis
WR6 ← 3A98h Write ; finish point of X axis : 15,000
WR7 ← 0000h Write
WR0 ← 0106h Write
WR6 ← 3E80h Write ; finish point of Y axis : 16,000
WR7 ← 0000h Write
WR0 ← 0206h Write
WR6 ← 4E20h Write ; finish point of Z axis : 20,000
WR7 ← 0000h Write
WR0 ← 0406h Write
WR0 ← 006Dh Write ; deceleration enabling
WR0 ← 0062h Write ; 3-axis linear interpolation driving

```

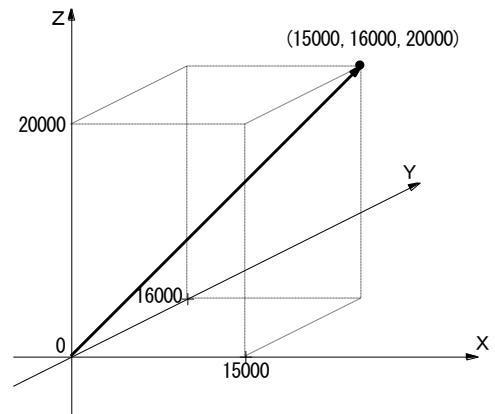

3.2 Circular Interpolation

Any 2 axes of the 4 axes can be set for circular interpolation.

In the orthogonal coordinates on the right figure, 2 axes are each set to the ax1 axis (horizontal axis) and ax2 axis (vertical axis) in order of priority X>Y>Z>U, the higher priority axis is set to ax1 axis and the lower priority axis is set to ax2 axis. The right direction of ax1 (horizontal axis) is + direction, and the upper direction of ax2 (vertical axis) is + direction.

If X and Y axes are selected, X axis becomes ax1 (horizontal axis) and Y axis becomes ax2 (vertical axis).

The user can reverse the axes by interpolation mode setting.

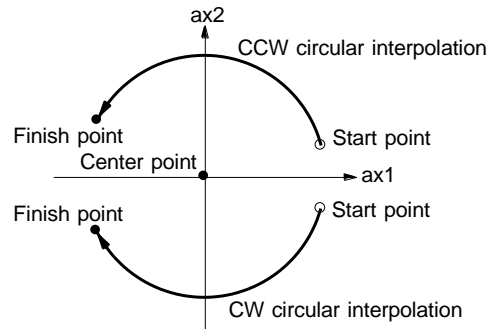

Fig. 3.2-1 CW/CCW circular interpolation

To execute circular interpolation, set the center point coordinates of a circular arc and the finish point coordinates relative to the present point coordinates (start point), and write CW or CCW circular interpolation driving command, then circular interpolation will be performed. The center and finish point coordinates must be set by the relative value to the present point coordinates.

In Fig. 3.2-1 CW circular interpolation, it explains the definition of CW and CCW circular interpolations. The CW circular interpolation is starting from the start point to the finish point in clockwise direction; the CCW circular interpolation is in counter-clockwise direction. When the finish point is set as (0, 0), a full circle will come out.

In Fig. 3.2-2, it explains the long axis and short axis. We define 8 quadrants in the X-Y plane and put the number 0~7 to each quadrant. As shown in the figure, the absolute value of ax1 is always larger than that of ax2 in quadrants 0, 3, 4 and 7, and it is defined ax1 is the long axis and ax2 is the short axis in these quadrants. In quadrants 1, 2, 5 and 6, ax2 is the long axis and ax1 is the short axis. The short axis outputs pulses regularly, and the long axis outputs or does not output pulses depending on the interpolation calculation.

In Fig. 3.2-3, it is an example to generate a full circle of radius 11 with the center point (-11,0) and the finish point (0,0). And Fig. 3.2-4 shows the pulse output at that time.

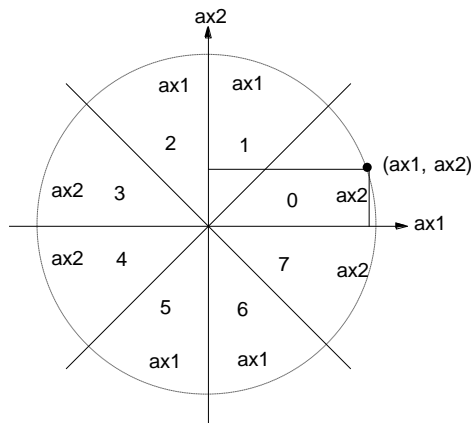

Fig. 3.2-2 The 0~7 Quadrants And Short Axis

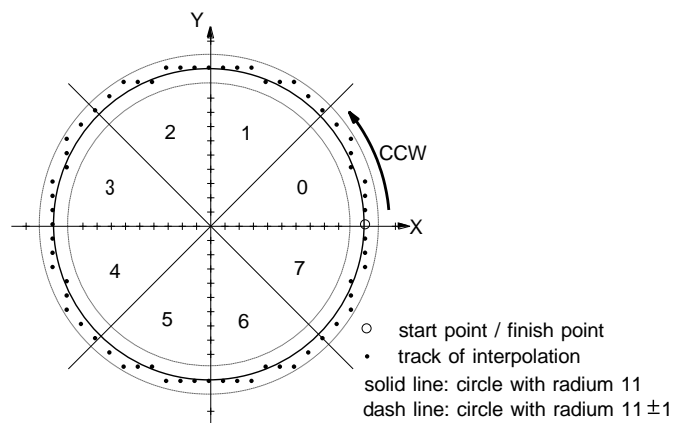

Fig. 3.2-3 Example of CircularInterpolation

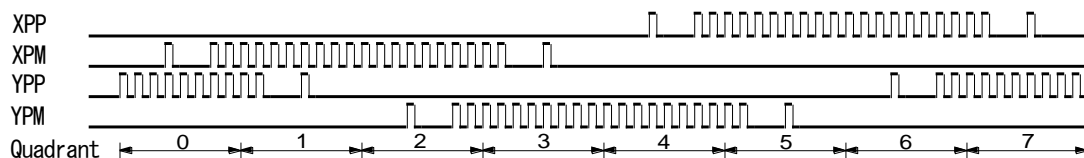

Fig. 3.2-4 Example of Pulse Output in Circular Interpolation Driving

The range of the center and finish point coordinates is -1,073,741,823~+1,073,741,823 from the current position. The position tolerance for the specified circular curve is ±1 LSB within the entire interpolation range. The interpolation speed is within the range from 1PPS to 8MPPS.

3.2.1 The Finish Point Checking of Circular Interpolation

In the circular interpolation, it assumes that the current position (start point) is (0,0). The radius is determined depending on the value of the center point coordinates, and then the circular tracking will start. The maximum error range of interpolation is within $\pm 1LSB$. Because of the $\pm 1LSB$ error range, the designated finish point may not be on the circular track. When the current point is same or over the finish point of short axis, this circular interpolation is finished in the quadrant where the finish point is. If the current point cannot reach the finish point of short axis, this circular interpolation is finished in the end of the quadrant where the current point reaches.

Fig. 3.2-5 shows an example of CCW interpolation with the start point (0,0), center point (-200,500) and finish point (-702, 299). The finish point is in quadrant 4, and ax2 is the short axis in quadrant 4. So the interpolation is finished when the ax2 is 299.

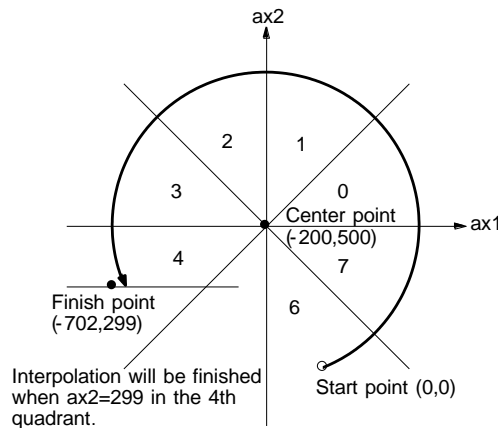

Fig. 3.2-5 CW/CCW Circular Interpolation

3.2.2 Toggle of Interpolation Axis

The interpolation axes are defined that the higher priority axis is set to ax1 (horizontal axis) and the lower priority axis is set to ax2 (vertical axis) in order of priority $X > Y > Z > U$. However, the user can toggle between the two axes. When the user wants to change the lower priority axis to ax1 (horizontal axis) and the higher priority axis to ax2 (vertical axis), set D4 bit of WR6 register as 1 by interpolation mode setting command (2Ah).

3.2.3 The Example for CW Circular Interpolation

This CW circular interpolation starts from the current point (start point: 0, 0) to the finish point (X: 5000, Y: -5000); the center point is X: 5000, Y: 0. The interpolating speed is constant at 1000PPS in 2-axis simple constant vector speed driving.

```

WR6 ← 0043h Write ; define: ax1:X axis, ax2:Y axis, and with 2-axis simple constant linear speed
WR0 ← 002Ah Write

WR6 ← 03E8h Write ; 1000 PPS
WR7 ← 0000h Write
WR0 ← 0104h Write ; Set initial speed to main axis

WR6 ← 03E8h Write ; 1000 PPS
WR7 ← 0000h Write
WR0 ← 0105h Write ; Set drive speed to main axis

WR6 ← 1388h Write ; center point of X : 5000
WR7 ← 0000h Write
WR0 ← 0108h Write

WR6 ← 0000h Write ; center point of Y : 0
WR7 ← 0000h Write
WR0 ← 0208h Write

WR6 ← 1388h Write ; finish point of X : 5000
WR7 ← 0000h Write
WR0 ← 0106h Write

WR6 ← EC78h Write ; finish point of Y : -5000
WR7 ← FFFFh Write
WR0 ← 0206h Write

WR0 ← 0064h Write ; CW circular interpolation driving
    
```

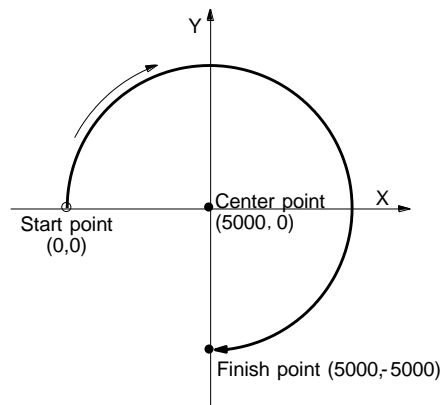

3.3 Helical Interpolation

Helical interpolation operates to move another axis in synchronization with the circular interpolation in the XY plane (orthogonal coordinates). The figure shown below is an example to move Z-axis in the + direction, corresponding to the circular interpolation on the XY plane. The figure 3.3-1 illustrates the helical interpolation under one rotation, and the figure 3.3-2 illustrates the helical interpolation in a plurality of rotations. MCX514 can perform both interpolation.

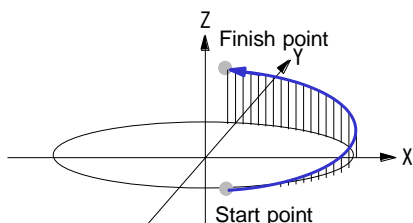

Fig. 3.3-1 Helical interpolation (under one rotation)

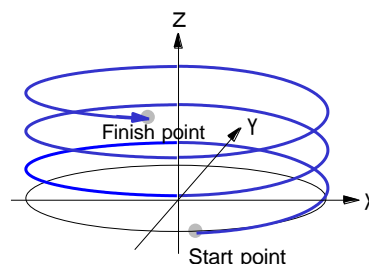

Fig. 3.3-2 Helical interpolation (one rotation or more)

As an application of helical interpolation, it is possible to operate normal control that rotates another axis by a constant angle corresponding to the circular interpolation on the XY plane. The figure 3.3-3 shows an example of the operation that an object such as a camera or nozzle on a pedestal is directed to the center of circular interpolation, mounting a rotating axis on the pedestal that performs circular interpolation on the XY plane.

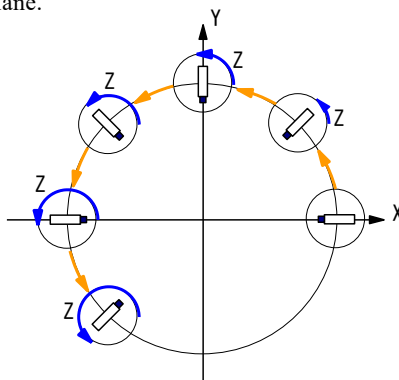

Fig. 3.3-3 Example of XY axes Circular Interpolation and Z axis Normal Control

It describes the procedures to perform helical interpolation. This is the helical interpolation to move Z-axis in synchronization with circular interpolation. MCX514 uses the total number of output pulses for circular interpolation and the drive pulse number of Z-axis in order to perform moving of Z-axis uniformly. The drive pulse number of Z-axis is predetermined, but it is hard to find out precisely the total number of output pulses in advance from the center and finish points for circular interpolation that is operated on the XY plane. For this reason, MCX514 performs helical calculation to find out the total number of output pulses for circular interpolation before executing helical interpolation driving. The procedures to perform helical interpolation are as follows.

Table 3.3-1 Operating Procedures to Perform Helical Interpolation

	Operation	Description
#1	Set interpolation axis	Set the axis to perform helical interpolation.
#2	Set interpolation speed	Set the speed for circular interpolation.
#3	Set helical rotation number	Set how many times to rotate.
#4	Set position data	Set the center and finish points for circular interpolation.
#5	Perform helical calculation	Find out the total number of output pulses for circular interpolation.
#6	Set position data	Set the center and finish points for circular interpolation and feed amount of Z and U axes.
#7	Perform helical interpolation	Perform helical interpolation.

#1 (Interpolation axis setting) must be done at first. Then perform #2 ~ #4 (in no particular order), and then perform #5 (helical calculation). After performing #5 (helical calculation), perform #6 (position data setting). The center and finish points for circular interpolation must be set again. And last of all perform #7 (helical interpolation). If these procedures are not followed, then interpolation may not be performed properly.

When the identical helical interpolation is performed continuously, there is no need to set and perform #1, #4 and #5, but the other operations must be set and performed again.

3.3.1 Interpolation Axis and Short Axis Pulse Equalization Mode Setting

In helical interpolation, the axes to perform circular interpolation are fixed in X and Y axes, which mean that the other axes cannot be used to perform circular interpolation. Z and U axes can be specified as the axes to move in synchronization with circular interpolation, and either one of Z and U axes or both axes can be moved (or rotated). Consequently for instance, a camera, nozzle or edged tool can be performed helical interpolation using Z-axis in the vertical direction to the circular interpolation plane, and the user performs rotation of a pedestal using U-axis and normal control of a head.

The interpolation axis can be set by interpolation mode setting command (2Ah). As shown below in D0~D3 bits of WR6 register, set 1 to the bit corresponding to the interpolation axis. 1 must be set to the bits of X and Y axes, and set to either bit of Z and U axes or both bits of them.

When executing interpolation drive, set “short axis pulse equalization mode” enable (see chapter 3.6.). Set D8 bit of WR6 register as 1.

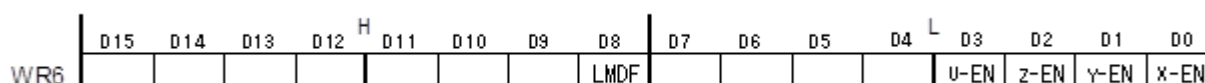

D3 U-EN	D2 Z-EN	D1 Y-EN	D0 X-EN	Action of Axis
0	1	1	1	Performs circular interpolation with X and Y axes, and moves Z axis in synchronization with circular interpolation.
1	0	1	1	Performs circular interpolation with X and Y axes, and moves U axis in synchronization with circular interpolation.
1	1	1	1	Performs circular interpolation with X and Y axes, and moves Z and U axes in synchronization with circular interpolation.

The other bits (D15~D4) of WR6 register is the setting bits related to interpolation. See chapter 7.3.8 and the set the appropriate values.

3.3.2 Interpolation Speed Setting

As the main axis of helical interpolation is X axis, the user sets the speed to X axis. For the setting of helical interpolation, please see chapter 3.6 Short Axis Pulse Equalization. The range of setting speed for helical interpolation is 1PPS~250KPPS. Normally, helical interpolation is performed at constant speed (no acceleration/deceleration), the user sets the same speed with the initial speed to drive speed to X-axis. The circular interpolation is performed on the XY plane with these setting speeds. The speed of Z and U axes that moves (rotates) in synchronization with circular interpolation is automatically determined depending on the speed of circular interpolation and feed amount of the axis, so there is no need to set it.

To make the interpolation speed more constant, “constant vector speed mode” is available, see chapter 3.5 for more details.

If the user wants to perform helical interpolation with more than 250Kpps, please contact us.

3.3.3 Helical Rotation Number Setting

When helical interpolation is performed one rotation or more, the user needs to set the number of rotation. If it is under one rotation, set 0. Write the rotation number within the range from 0 to 65,535 in WR6 register and write helical rotation number setting command (1Ah), and the number of rotation will be set. Axis assignment for the command is not necessary.

■ Regarding the rotation number of full circle in helical interpolation

If the finish point is set as (0, 0) in both X and Y axes, a full circle comes out. In this case whether the helical rotation number is set as 0 or 1, the number of rotation is 1. If 2 or more is set, it will rotate the number being set.

3.3.4 Position Data Setting

It sets the center point (X, Y) and finish point of circular interpolation that is operated on the XY plane. In addition, if the user moves Z or U axis in synchronization with circular interpolation, set the feed amount of Z or U axis respectively.

Table 3.3-2 Position Data Setting for Helical Interpolation

Setting Data	Description
Center point of circular interpolation	Set the center point (X, Y) by the relative value with respect to the current position (previous position before starting helical interpolation). Write the value in WR6, 7 registers and circular center point setting command (08h) with axis assignment in WR0 register.
Finish point of circular interpolation	Set the finish point (X, Y) by the relative value with respect to the current position. Write the value in WR6, 7 registers and drive pulse number / finish point setting command (06h) with axis assignment in WR0 register.
Feed amount of Z / U axis	<ul style="list-style-type: none"> Set the feed amount of the axis in synchronization with circular interpolation by the relative value with respect to the current position. When it is moved in the + direction, set the positive value and when in the - direction, set the negative value. Write the value in WR6, 7 registers and drive pulse number / finish point setting command (06h) with axis assignment in WR0 register. When circular interpolation is under one rotation, set the feed amount up to the finish point (see Fig. 3.3-4 (a)). When it is one rotation or more, set the feed amount of the axis for one rotation of circular interpolation (see Fig. 3.3-4 (b)). The feed amount of Z or U axis being set must be smaller than the total number of output pulses for circular interpolation (the value that can be found out by helical calculation). Generally, it is required that the value is smaller than the length of the circular arc of circular interpolation.

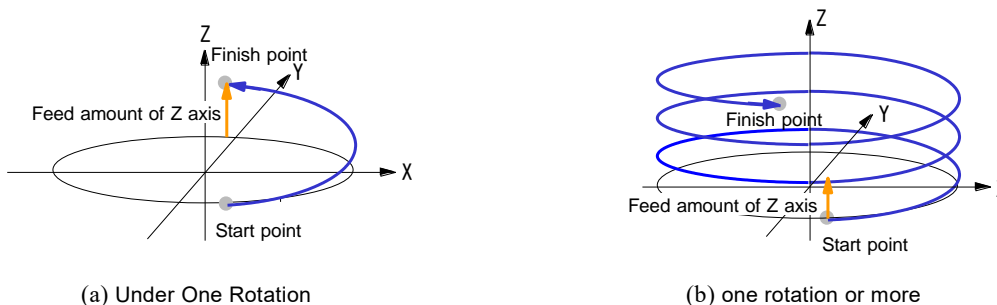

Fig. 3.3-4 The Feed Amount of Z/U axis

The center and finish points for circular interpolation can be set as well as the normal circular interpolation. For just one rotation, set (0, 0). When the user performs the rotation one or more and finishes it at the position of the start point, set (0, 0).

When performing helical calculation, it is not necessary to set the feed amount of Z and U axes.

3.3.5 Helical Calculation Execution

It is required that the total number of output pulses for circular interpolation is found out in advance in order to perform moving of Z-axis uniformly in helical interpolation. Helical calculation command is to find out this total number of output pulses.

Before execution of helical calculation, an interpolation axis, interpolation speed, helical rotation number and position data (the center and finish points for circular interpolation) must be set. Helical calculation is performed based on these parameters.

There are two helical calculations: CW helical calculation and CCW helical calculation. Please be sure to execute the command in the same rotation direction of the circular arc as helical interpolation. If the rotation direction is different, interpolation cannot be performed correctly.

Write CW helical calculation command (6Bh) or CCW helical calculation command (6Ch) in WR0 register, then it will be executed.

Table 3.3-3 Helical Calculation Command

Helical calculation command code	Helical calculation
6Bh	CW helical calculation
6Ch	CCW helical calculation

While performing the calculation, D0, D1 (XDRV, YDRV) bits become 1, and when it is finished, they return to 0. Or the user can know whether the calculation is finished by generating an interruption at the end of driving. For more details of interrupt, see chapter 2.10.

■ Reading and Writing of helical calculation result

When helical calculation is finished after execution, the user can obtain the helical calculation result (the total number of output pulses for circular interpolation). This value can be read by helical calculation value reading command (3Bh). Write helical calculation value reading command (3Bh) in WR0 register, and read from RR6, RR7 registers.

If the same helical interpolation (that has the same helical rotation number, the center and finish points for circular interpolation and the feed amount of Z/U axis) is performed again and again, there is no need to execute helical calculation every interpolation. Read the helical calculation result already obtained by using helical calculation value reading command (3Bh) and set that value next time, and then the user can shift helical interpolation. To write the helical calculation result, use helical calculation setting command (1Bh). Write the helical calculation result in WR6, 7 registers and write helical calculation setting command (1Bh) in WR0 register, and the value will be set to IC internal register.

[Note]

- Be sure that all bits of interpolation mode setting command (2Ah) must be the same, otherwise helical calculation and helical interpolation will not work properly.

■ Execution time of helical calculation

The execution time of helical calculation is shown in the table below. The execution time of helical calculation is determined depending on the radius of the circular arc of XY axes in helical interpolation. The calculation time only takes the time to calculate the one rotation of the circular arc at a maximum. When the helical rotation number is 1 or more, the value in the table below will be applied regardless of any value being set as the helical rotation number. When it is under 1, the value will be smaller than the value in the table based on its rotation angle.

Table 3.3-4 Execution time of Helical Calculation

Radius r of circular interpolation (pulse)	Execution time t of helical calculation (msec)	
	Short axis pulse equalization mode Disabling	Short axis pulse equalization mode Enabling
1,000	0.7	5.6
10,000	7	56
100,000	70	565
1,000,000	707	5,656

The radius of circular interpolation can be found out from the center points (xc, yc) that is set to MCX514. The radius and execution time are calculated by the following formula.

$$\text{Radius of circular arc } r = \sqrt{(xc^2 + yc^2)}$$

$$\text{Execution time } t = (1 \times 10^{-6} \times r) / \sqrt{2} \quad (2)$$

[Note]

- The execution time is multiplied by 8 times in short axis pulse equalization mode.

3.3.6 Helical Interpolation Execution

Before performing helical interpolation, set the position data that is set in chapter 3.3.4 again, and then helical interpolation will be performed by CW helical interpolation driving command (69h) or CCW helical interpolation driving command (6Ah). Write CW helical interpolation driving command (69h) in WR0 register when to rotate the circular arc on the XY plane in the CW direction, and write CCW helical interpolation driving command (6Ah) in WR0 register when to rotate it in the CCW direction, and then helical interpolation will be performed.

Table 3.3-5 Helical Interpolation Command

Helical Interpolation Command code	Helical Interpolation
69h	CW helical interpolation
6Ah	CCW helical interpolation

Before starting helical interpolation, all the necessary data must be set. For more details of setting items, see chapter from 3.3.1 to 3.3.5.

3.3.7 Current Helical Rotation Number Reading

During helical interpolation, the user can read the current rotation number by current helical rotation number reading command (3Ah). The helical rotation number is counted up at the timing when it returns to the start point after one rotation of circular interpolation.

3.3.8 Position Drift in Helical Interpolation

Helical interpolation performs circular interpolation in the XY plane, and moves Z or U axis in synchronization with the circular interpolation. Ideally, the increased amount of the rotation angle in the center of circular interpolation must be directly proportional to the increased amount of Z/U axis feed as shown in Fig. 3.3-5. However, as the circular interpolation in MCX514 is performed in the XY orthogonal coordinates, the increased amount of output pulses in X and Y axes is not directly proportional to the increased amount of the rotation angle in the center of circular interpolation. This affects the Z/U axis feed that is calculated by output pulses from X and Y axes of circular interpolation, as a result, it is not also directly proportional. Each time the quadrant changes in circular interpolation, periodic drift is generated.

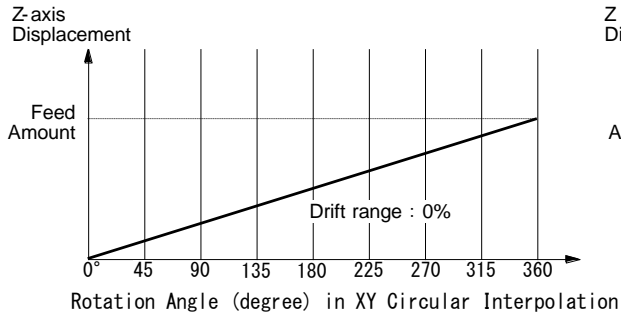

Fig. 3.3-5 Ideal Z-axis Feed in Helical Interpolation

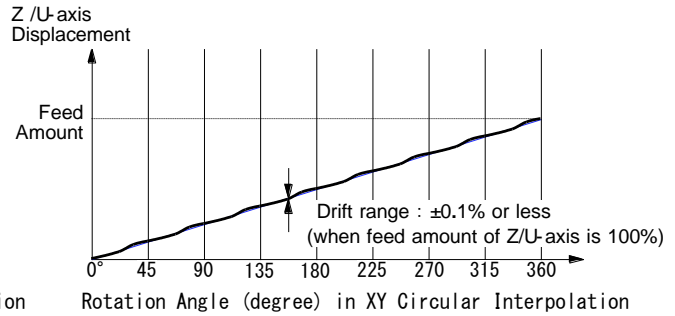

Fig. 3.3-6 MCX514 Z/U axis Drift in Helical Interpolation

As shown in Fig. 3.3-6, the position of Z or U axis is, each time the quadrant changes in circular interpolation, periodic drift is generated. The drift range from an ideal position depends on operation environment and as follows.

Table 3.3-6 Drift Range of Feed Amount from Ideal Position

Operating Condition	Drift Range from Ideal Position
Short axis pulse equalization mode +	±0.1% or less
2-axis high accuracy constant vector speed mode	
Without both Short axis pulse equalization and constant vector speed mode	±0.4% or less

For more details of short axis pulse equalization mode, see chapter 3.6.

For more details of constant vector speed mode, see chapter 3.5.

3.3.9 Notes on Helical Interpolation

- Helical interpolation can be executed for constant speed driving only. It cannot be executed for acceleration/deceleration driving and continuous interpolation driving.
- Speed range of helical interpolation is 1~250Kpps.
- Make sure to use with short axis pulse equalization mode.
- For helical interpolation, if the start and finish points of a circular arc are not on X or Y-axis, the finish points of the both axes may deviate by ± 1 pulse. When one rotation or more are executed in helical interpolation driving, this deviate may accumulate. When the start and finish points of a circular arc are on X or Y-axis, this deviate does not occur.
- Set the feed amount of Z and U-axis less than the total output pulse of circular interpolation which is set for helical interpolation.

3.3.10 Examples of Helical Interpolation

■ Example 1 Helical Interpolation under 1 rotation (X, Y, Z axes)

It performs CCW circular interpolation that has the center at the relative position (X:0, Y:10000) from the start point (current point), and terminates it at the finish point (X:-3490, Y:19397).

At this time, it moves Z axis from the current position to +3000 in synchronization with circular interpolation. The speed of circular interpolation is 1000PPS at constant speed.

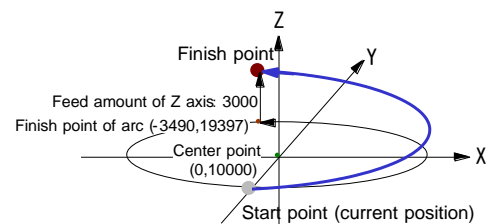

```

WR6 ← 01C7h Write      ; XY axes Circular arc + Z axis, 2-axis high accuracy constant vector speed mode
WR0 ← 002Ah Write      ; Short axis pulse equalization : Enable

WR6 ← 03E8h Write      ; 1000 PPS
WR7 ← 0000h Write
WR0 ← 0104h Write      ; Set initial speed to main axis X

WR6 ← 03E8h Write      ; 1000 PPS
WR7 ← 0000h Write
WR0 ← 0105h Write      ; Set drive speed to main axis X

WR6 ← 0000h Write      ; Helical rotation number : 0
WR0 ← 001Ah Write

WR6 ← 0000h Write      ; Circle center X : 0
WR7 ← 0000h Write
WR0 ← 0108h Write

WR6 ← 2710h Write      ; Circle center Y : 10000
WR7 ← 0000h Write
WR0 ← 0208h Write

WR6 ← F25Eh Write      ; Circle finish point X : -3490
WR7 ← FFFFh Write
WR0 ← 0106h Write

WR0 ← 006Ch Write      ; CCW helical calculation (calculation time : About 56ms)

RR0 → Read              ; Waits for termination of calculation (D0 bit = 0 waiting)

WR6 ← 0000h Write      ; Circle center X : 0
WR7 ← 0000h Write
WR0 ← 0108h Write

WR6 ← 2710h Write      ; Circle center Y : 10000
WR7 ← 0000h Write
WR0 ← 0208h Write

WR6 ← F25Eh Write      ; Circle finish point X : -3490
WR7 ← FFFFh Write
WR0 ← 0106h Write

WR6 ← 4BABh Write      ; Circle finish point Y : 19371
WR7 ← 0000h Write
WR0 ← 0206h Write

WR6 ← 0BB8h Write      ; Feed amount of Z : 3000
WR7 ← 0000h Write
WR0 ← 0406h Write

WR0 ← 006Ah Write      ; Starts CCW helical interpolation driving

RR0 → Read              ; Waits for termination of interpolation (D0 bit = 0 waiting)

```

■ Example 2 Helical Interpolation with multiple rotations (X, Y, Z axes)

It performs CW circular interpolation that has the center at the relative position (X:0, Y:10000) from the start point (current point), and moves Z axis 3000 pulses every 1 rotation, and terminates it with 7 rotations.

The speed of circular interpolation is 1000PPS at constant speed.

To perform helical Interpolation with 1 rotation or more, set the feed amount of one rotation of circular interpolation to the feed amount of Z axis.

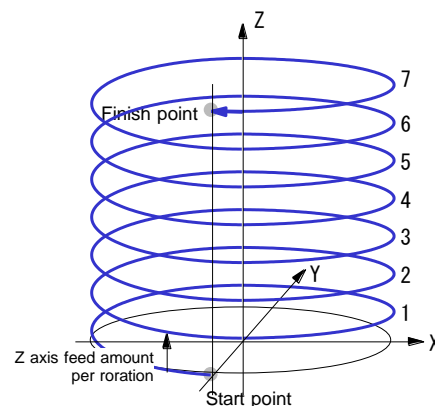

```

WR6 ← 01C7h Write high ; XY axes Circular arc + Z axis, 2-axis
WR0 ← 002Ah Write ; accuracy constant vector speed mode
; Short axis pulse equalization : Enable

WR6 ← 03E8h Write ; 1000 PPS
WR7 ← 0000h Write
WR0 ← 0104h Write ; Set initial speed to main axis X

WR6 ← 03E8h Write ; 1000 PPS
WR7 ← 0000h Write
WR0 ← 0105h Write ; Set drive speed to main axis X

WR6 ← 0007h Write ; Helical rotation number : 7
WR0 ← 001Ah Write

WR6 ← 0000h Write ; Circle center X : 0
WR7 ← 0000h Write
WR0 ← 0108h Write

WR6 ← 2710h Write ; Circle center Y : 10000
WR7 ← 0000h Write
WR0 ← 0208h Write

WR6 ← 0000h Write ; Circle finish point X : 0
WR7 ← 0000h Write
WR0 ← 0106h Write

WR6 ← 0000h Write ; Circle finish point Y : 0
WR7 ← 0000h Write
WR0 ← 0206h Write

WR0 ← 006Bh Write ; CW helical calculation (calculation time : About 56ms)

RRO → Read ; Waits for termination of calculation (D0 bit = 0 waiting)

WR6 ← 0000h Write ; Circle center X : 0
WR7 ← 0000h Write
WR0 ← 0108h Write

WR6 ← 2710h Write ; Circle center Y : 10000
WR7 ← 0000h Write
WR0 ← 0208h Write

WR6 ← 0000h Write ; Circle finish point X : 0
WR7 ← 0000h Write
WR0 ← 0106h Write

WR6 ← 0000h Write ; Circle finish point Y : 0
WR7 ← 0000h Write
WR0 ← 0206h Write

WR6 ← 0BB8h Write ; Feed amount of Z : 3000
WR7 ← 0000h Write
WR0 ← 0406h Write

WR0 ← 0069h Write ; Starts CW helical interpolation driving

RRO → Read ; Waits for termination of interpolation (D0 bit = 0 waiting)

```

■ Example 3 Helical Interpolation with both Z and U axes (X, Y, Z and Z axes)

It performs the radius 10000 of circular interpolation with one rotation in the CCW direction. During one rotation of circular interpolation, move Z axis 3000 pulses and rotate U axis once (400 pulses). The speed of circular interpolation is 1000PPS at constant speed.

```

WR6 ← 01CFh Write ; XY axes Circular arc + Z, U axes, 2-axis high accuracy constant vector speed mode
WR0 ← 002Ah Write ; Short axis pulse equalization : Enable

WR6 ← 03E8h Write ; 1000 PPS
WR7 ← 0000h Write
WR0 ← 0104h Write ; Set initial speed to main axis X

WR6 ← 03E8h Write ; 1000 PPS
WR7 ← 0000h Write
WR0 ← 0105h Write ; Set drive speed to main axis X

WR6 ← 0001h Write ; Helical rotation number : 1
WR0 ← 001Ah Write

WR6 ← 0000h Write ; Circle center X : 0
WR7 ← 0000h Write
WR0 ← 0108h Write

WR6 ← 2710h Write ; Circle center Y : 10000
WR7 ← 0000h Write
WR0 ← 0208h Write

WR6 ← 0000h Write ; Circle finish point X : 0
WR7 ← 0000h Write
WR0 ← 0106h Write

WR6 ← 0000h Write ; Circle finish point Y : 0
WR7 ← 0000h Write
WR0 ← 0206h Write

WR0 ← 006Ch Write ; CCW helical calculation (calculation time : About 56ms)

RR0 → Read ; Waits for termination of calculation (D0 bit = 0 waiting)

WR6 ← 0000h Write ; Circle center X : 0
WR7 ← 0000h Write
WR0 ← 0108h Write

WR6 ← 2710h Write ; Circle center Y : 10000
WR7 ← 0000h Write
WR0 ← 0208h Write

WR6 ← 0000h Write ; Circle finish point X : 0
WR7 ← 0000h Write
WR0 ← 0106h Write

WR6 ← 0000h Write ; Circle finish point Y : 0
WR7 ← 0000h Write
WR0 ← 0206h Write

WR6 ← 0BB8h Write ; Feed amount of Z : 3000
WR7 ← 0000h Write
WR0 ← 0406h Write

WR6 ← 0190h Write ; Feed amount of U : 400
WR7 ← 0000h Write
WR0 ← 0806h Write

WR0 ← 006Ah Write ; Starts CCW helical interpolation driving

RR0 → Read ; Waits for termination of interpolation (D0 bit = 0 waiting)

```

3.4 Bit Pattern Interpolation

MCX514 bit pattern interpolation is the operation that performs interpolation of several axes by specifying whether to output pulses in the + or - direction by a unit of 1 drive pulse. It can interpolate from 2 axes up to 4 axes.

The user sets drive pulse in the + or - direction by one bit one pulse from the CPU to each interpolation axis, 1 is to output and 0 is not to output. For example, to draw the profile as shown in the right Fig. 3.4-1, if output of drive pulse each in X+, X-, Y+, Y- direction is "1", and no output is "0", the bit pattern data is as follows.

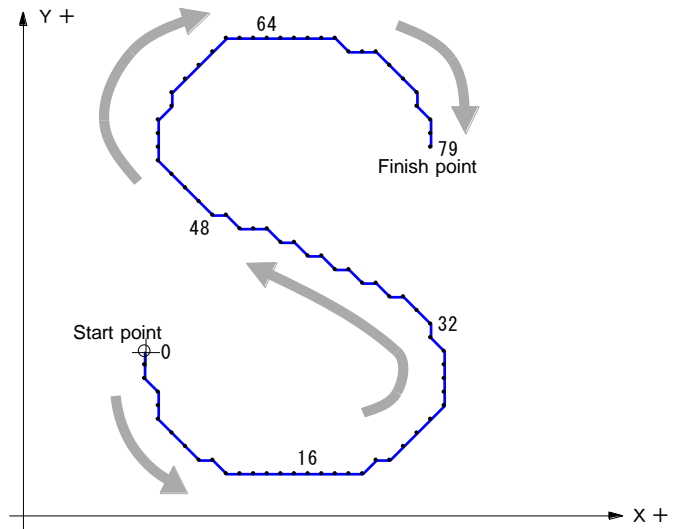

Fig. 3.4-1 Example of Bit Pattern Interpolation

```

        64          48          32          16          0
10010111 11111111 11111110 10000000 00000000 00000000 00000011 11111111 11111111 11100100 :XPP(X+direction pulse)
10000000 00000000 00000000 00001111 11111111 11111111 01000000 00000000 00000000 00000000 :XPM(X-direction pulse)
00000000 00000000 00011111 11111111 01001010 10101011 11111111 11010000 00000000 00000000 :YPP(Y+direction pulse)
01111111 00100000 00000000 00000000 00000000 00000000 00000000 00000000 00000011 11111111 :YPM(Y-direction pulse)
    
```

The operation procedures to perform bit pattern interpolation are as follows.

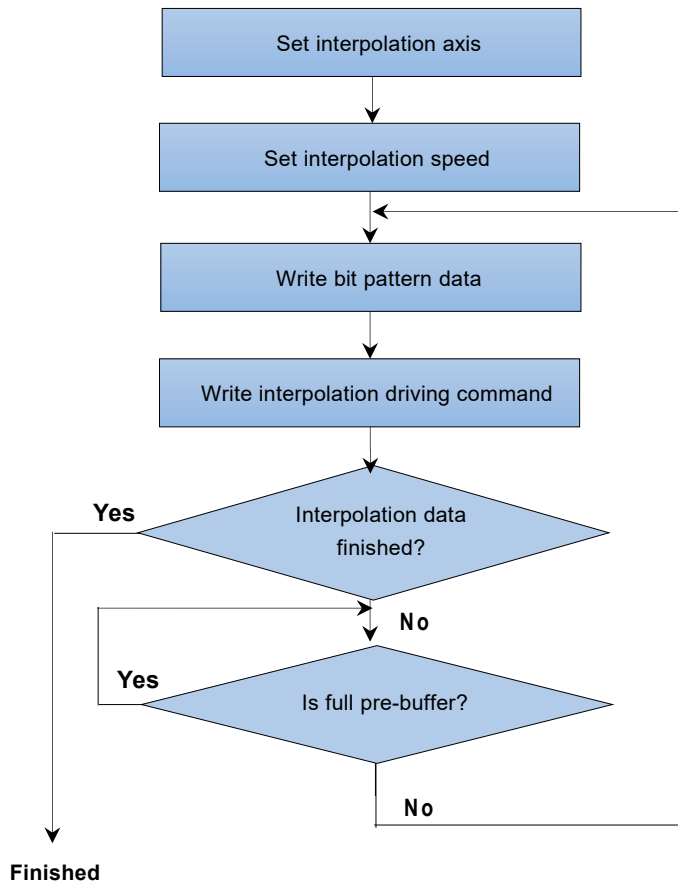
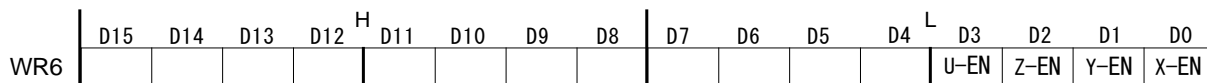

Fig. 3.4-2 Operation Procedures for Bit Pattern Interpolation

3.4.1 Designation of Interpolation Axis

Interpolation axis can be specified by interpolation mode setting command (2Ah). As shown below, set D0~D3 bits of WR6 register, set 1 to the bit corresponding to the axis that interpolation is performed. Bit pattern interpolation can be performed with from 2 axes to all 4 axes, but it cannot specify only 1 axis.



The other bits (D15~D4) of WR6 register are the setting bit related to interpolation. Please refer to 7.3.8, and set appropriate values.

3.4.2 Interpolation Speed Setting

It sets the drive speed for bit pattern interpolation to the main axis among interpolation axes. The drive speed can be set up to 4MHz at a maximum in bit pattern interpolation mode. However, if the bit pattern data is more than 128 bits, the maximum speed will depend on the BP data update rate of a host CPU because the CPU is required to replenish BP data to pre-buffer (described below) during interpolation driving. For example of 2 axes bit pattern interpolation, the host CPU must write (16 bit data × 2 + 16 bit command) × 2 axes + interpolation driving command in order to update BP data. If it takes 100µsec, output time of 16 bit (=16 drive pulses) must be longer than that. Thereby, interpolation drive speed must be lower than 1 / (100µSEC / 16) = 160KPPS. If the higher value is set, replenishment of BP data does not catch up.

3.4.3 Bit Pattern Data Writing

It writes bit pattern data for each interpolation axis. Write bit data of 16 bit in the + direction to WR6 register, and write bit data of 16 bit in the - direction to WR7 register. The 16 bit data will be output as drive pulse from D0 bit to the upper bit in turn. When drive pulse number / finish point setting command (06h) is written with axis assignment in WR0 register, BP data is stored in pre-buffer, which is applied to all interpolation axes.

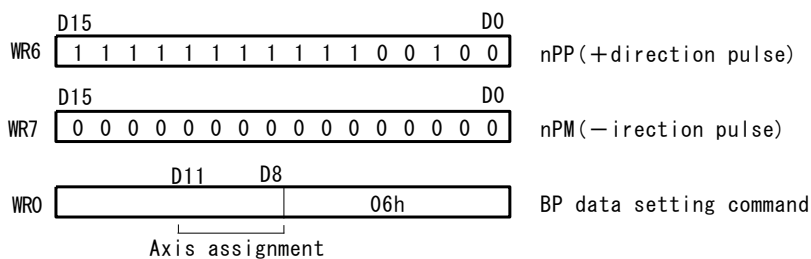

Fig. 3.4-3 Bit Pattern Data Writing

3.4.4 Write of Interpolation Driving Command

After writing bit pattern data of all axes, write bit pattern interpolation driving command to WR0 register. It can interpolate from 2 axes to 4 axes. The codes of interpolation driving commands are as follows.

Table 3.4-1 Bit Pattern Interpolation Command

Interpolation command	Code
2-axis bit pattern interpolation driving	66h
3-axis bit pattern interpolation driving	67h
4-axis bit pattern interpolation driving	68h

Axis assignment is not necessary. When a command is written in WR0 register, a stage of pre-buffer is updated (stack counter is counted up by 1), and interpolation driving is performed immediately. If the user wants to start interpolation after storing a certain amount of bit pattern data in pre-buffer, set drive start holding command (77h) to the main axis in advance. Write drive start holding release command (78h) to the main axis after bit pattern data and interpolation command are written in several stages, interpolation driving will be performed.

[Note]

- It is necessary to write bit pattern interpolation driving command after writing bit pattern data into all the axes. Pre-buffer is updated by writing bit pattern interpolation driving command.

3.4.5 Termination of Interpolation

There are 2 ways to terminate bit pattern interpolation as follows.

① Write an end code to bit pattern data of interpolation axis.

When 1 is set to bit data in the both + and - directions of any interpolation axes, it is determined that bit pattern interpolation is finished. Bit pattern data after the end code will be invalid.

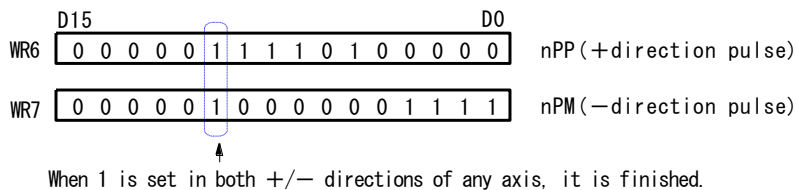

Fig. 3.4-4 Termination of Bit Pattern Interpolation by End Code

② Cancel the writing of data.

When the writing of bit pattern data is canceled, all bit pattern data stacked in pre-buffer is output as drive pulse and then bit pattern interpolation is finished.

3.4.6 Check Available Space of Pre-buffer

MCX514 has 8 stages of pre-buffer for continuous interpolation. In bit pattern interpolation, it can store 8 stages of 16 bit pattern data for each of all interpolation axes, that is, $16 \times 8 = 128$ bits. When the user performs interpolation over 128 bits, the user must check the free space of pre-buffer during interpolation. The 4 bits of D12~D15 in RR0 register displays this stack counter value of pre-buffer. When the value of 4 bits is 0, it indicates an empty state, and when it is 8, it indicates a full state and cannot write BP data anymore. When bit pattern interpolation command is written, the stack counter is counted up by 1 and interpolation driving starts. When output of 16 bits is finished, the stack counter is counted down by 1.

D11 bit (CNEXT) of RR0 register notifies the writable state of next data for continuous interpolation. After interpolation driving starts, CNEXT bit becomes 1 while the stack counter of pre-buffer is from 1 to 7. And during 1 of this bit, the host CPU determines that it is possible to write next data.

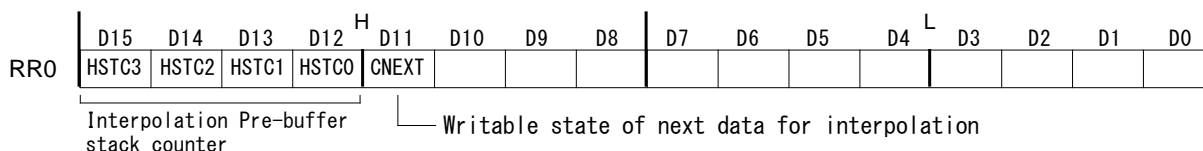

3.4.7 Interruption of Interpolation Driving

■ Interruption by stop command

When instant or decelerating stop command is written to the main axis that performs bit pattern interpolation, interpolation driving stops.

The stack counter of pre-buffer becomes 0 forcibly, and bit pattern data stacked in pre-buffer will be invalid.

■ Interruption by hardware limit or software limit

During interpolation driving, when hardware or software limit of any axis becomes active, interpolation driving stops.

In bit pattern interpolation, even hardware or software limit of either + or – direction becomes active, interpolation driving may stop. So please note that the user cannot escape from the limit area in bit pattern interpolation.

3.4.8 Example of Bit Pattern Interpolation

It performs bit pattern interpolation of $m \times 16$ bits with X and Y axes. For example, in case of Fig. 3.4-1 Example of Bit Pattern Interpolation, it has 79 bits and so $m = 5$. Set interpolation drive speed: 1000PPS at constant speed and 2-axis simple constant vector speed mode. The main axis is X axis, so set drive speed to X axis.

Bit pattern data should be stored in a memory as shown in the table below.

	m = 5	m = 4	m = 3	m = 2	m = 1
X-axis +direction data X_PlusBPdata (m)	1001011111111111 97FFh	1111111010000000 FE80h	0000000000000000 0000h	0000001111111111 03FFh	1111111111100100 FFE4h
X-axis -direction data X_MinusBPdata (m)	1000000000000000 8000h	0000000000001111 000Fh	1111111111111111 FFFFh	0100000000000000 4000h	0000000000000000 0000h
Y-axis +direction data Y_PlusBPdata (m)	0000000000000000 0000h	0001111111111111 1FFFh	0100101010101011 4AABh	111111111010000 FFD0h	0000000000000000 0000h
Y-axis -direction data Y_MinusBPdata (m)	0111111100100000 7F20h	0000000000000000 0000h	0000000000000000 0000h	0000000000000000 0000h	0000001111111111 03FFh

```

WR6 ← 0043h Write           ; Xaxis and Yaxis, 2-axis simple constant vector speed mode
WR0 ← 002Ah Write           ; Set interpolation mode

WR6 ← 03E8h Write           ; Xaxis (main axis) Set speed parameters
WR7 ← 0000h Write           ; Initial speed : 1000 PPS
WR0 ← 0104h Write

WR6 ← 03E8h Write           ; Drive speed : 1000 PPS
WR7 ← 0000h Write
WR0 ← 0105h Write

m ← 1                       ; Data pointer = 1

Loop:
WR6 ← X_PlusBPdata(m) Write ; Xaxis +direction BP data
WR7 ← X_MinusBPdata(m) Write ; Xaxis -direction BP data
WR0 ← 0106h Write

WR6 ← Y_PlusBPdata(m) Write ; Yaxis +direction BP data
WR7 ← Y_MinusBPdata(m) Write ; Yaxis -direction BP data
WR0 ← 0206h Write

WR0 ← 0066h Write           ; 2-axis BP interpolation command
                               ; Starts interpolation driving by the first execution of this step

m ← m + 1                   ; Data pointer is incremented
                               ; If m = 6, it is terminated.

RR0 → Read                  ; Checks free space of pre-buffer
                               ; If RR0/D11 = 1, jump to Loop, and if = 0, go to RR0 Read

```

■ Bit pattern interpolation by interrupt

The interrupt signal (INT1N) for continuous interpolation is provided. This signal becomes active (Low level) when the stack counter of pre-buffer changes from 8 to 7 or from 4 to 3.

After the interrupt signal is generated, the host CPU can write the next BP data until the stack counter becomes 8 (while CNEXT bit is 1). It means that the host CPU can write the next BP data of 1 stage when selected from 8 to 7, and 5 stages continuously when selected from 4 to 3.

The interrupt signal (INT1N) will return to inactive by writing interpolation command (such as 2/3/4-axis bit pattern interpolation command) after BP data is written. And it will return to inactive forcibly when interpolation driving is finished.

3.5 Constant Vector Speed

Vector speed is the driving speed of the tip of a locus performing interpolation driving, and it is also called Head speed. In operations such as machining or coating workpieces during interpolation driving, it is important to keep this vector speed constant. MCX514 provides 2-axis simple constant vector speed mode and 2-axis high accuracy constant vector speed mode for 2-axis interpolation. In addition, it provides 3-axis simple constant vector speed mode for 3-axis interpolation.

Fig. 3.5-1 shows the locus of 2 axes interpolation in the orthogonal XY plane. Each axis outputs drive pulses according to the basic pulse of the main axis. And as shown in the figure, when both axes output drive pulses, it moves 1.414 times longer distance than that of 1-axis output.

If not using constant vector speed mode when both axes outputs drive pulses, the speed will be 1.414 times faster even though the driving distance is 1.414 times longer.

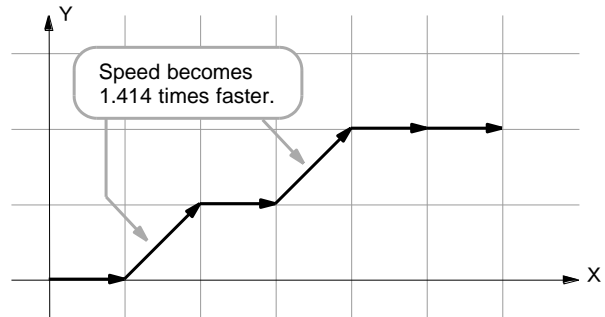

Fig. 3.5-1 Example of 2-axis Interpolation

Fig. 3.5-2 shows the speed deviation of vector speed within the range from 0 to 90 degrees of the angle between X axis and the line to be interpolated when linear interpolation is performed in the orthogonal XY plane. Although the figure shows the range 0 – 90 degrees, the range 90 – 180, 180 – 270, 270 – 360 are the same.

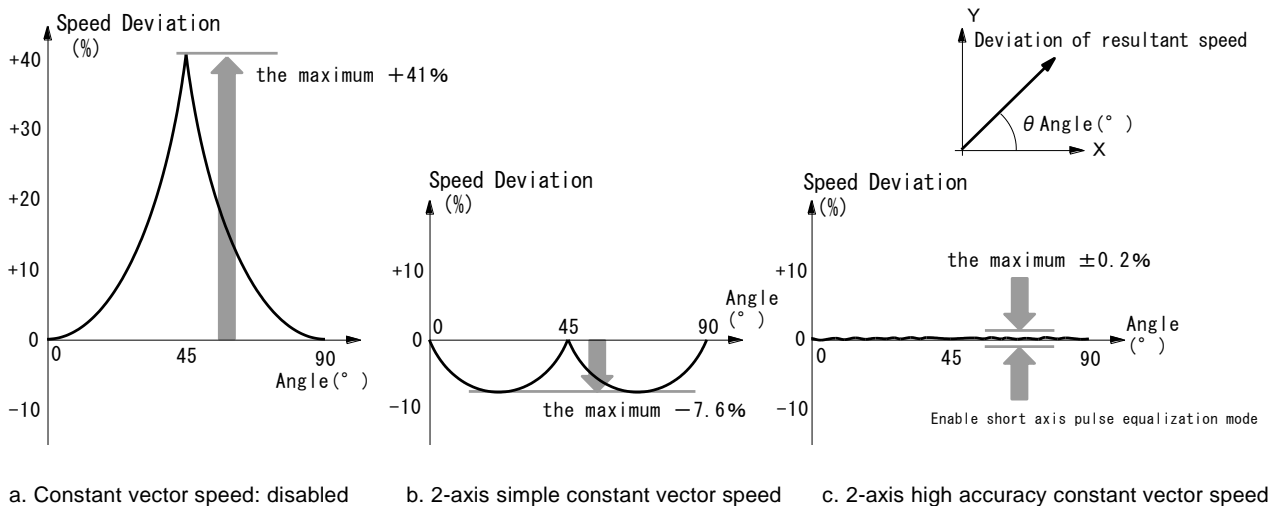

Fig. 3.5-2 Speed Deviation of Vector Speed with respect to Setting Speed in Linear Interpolation Driving

Fig. 3.5-2 a. is the speed deviation of vector speed with respect to the setting drive speed when constant vector speed mode is disabled. When the angle from X axis is 45 degrees, the speed deviation will be maximum and the speed will increase by approximately +41%.

Fig. 3.5-2 b. is the speed deviation in 2-axis simple constant vector speed mode, where the speed deviation is improved by setting 1/1.414 times pulse cycle for both axes pulse output.

Fig. 3.5-2 c. is the speed deviation in 2-axis high accuracy constant vector speed mode, where the speed deviation can be kept $\pm 0.2\%^{*1}$ or less in the range of all angles. $*1$: Short axis pulse equalization mode must be enabled.

3-axis simple constant vector speed mode is available for 3-axis linear interpolation, where the speed deviation is improved by setting 1/1.414 times pulse cycle when pulses of any 2 axes among 3 axes are output, and improved by setting 1/1.732 times pulse cycle when pulses of all 3 axes are output.

3.5.1 Constant Vector Speed Setting

Constant vector speed can be set by 2 bits, D6 and D7 of interpolation mode setting command (2Ah).

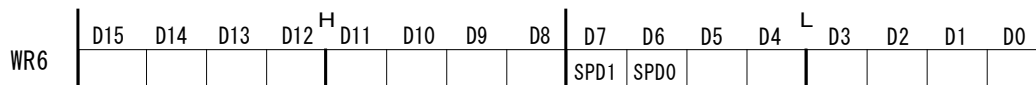

The settings of D6 and D7 bits corresponding to each constant vector speed mode are as follows.

Table 3.5-1 Settings of Constant Vector Speed Mode

D7(SP1) Bit	D6(SP0) Bit	Constant Vector Speed Mode
0	0	Invalid
0	1	2-axis simple constant vector speed
1	0	3-axis simple constant vector speed
1	1	2-axis high accuracy constant vector speed

■ Example of linear interpolation in 2-axis high accuracy constant vector speed mode

It performs linear interpolation of X and Y axes with drive speed: 1000PPS at constant speed in 2-axis high accuracy constant vector speed mode, and short axis pulse equalization mode is enabled.

```
// Set interpolation mode
WR6 ← 01C3h Write // XY axes interpolation, 2-axis high accuracy constant vector speed mode,
// Short axis pulse equalization mode enabling
WR0 ← 002Ah Write // Interpolation mode setting command

// Set drive speed to main axis
WR6 ← 03E8h Write // Initial speed : 1000pps
WR7 ← 0000h Write
WR0 ← 0104h Write

WR6 ← 03E8h Write // Drive speed : 1000pps
WR7 ← 0000h Write
WR0 ← 0105h Write

// Set Finish point
WR6 ← 03E8h Write // Finish point X : 1000
WR7 ← 0000h Write
WR0 ← 0106h Write

WR6 ← 0190h Write // Finish point Y : 400
WR7 ← 0000h Write
WR0 ← 0206h Write

// Start interpolation driving
WR0 ← 0061h Write // 2-axis linear interpolation driving
```

3.6 Short Axis Pulse Equalization

Usually in interpolation driving, all of axes that perform interpolation do not output drive pulses at regular intervals during driving. As shown in Fig. 3.6-1 a. below, in 2-axis linear interpolation, the axis (long axis) that has longer moving distance (pulse) outputs pulses continuously; however, the axis (short axis) that has shorter one sometimes outputs and sometimes does not output pulses depending on the result of interpolation calculation. In a stepper motor, these uneven pulses may increase mechanical vibration.

Short axis pulse equalization mode is the function to improve this problem. Even in the axis has shorter moving distance, it can output drive pulses as equal as possible. The following Fig. 3.6-1 b. shows the waveform of the output pulse when short axis pulse equalization mode is enabled.

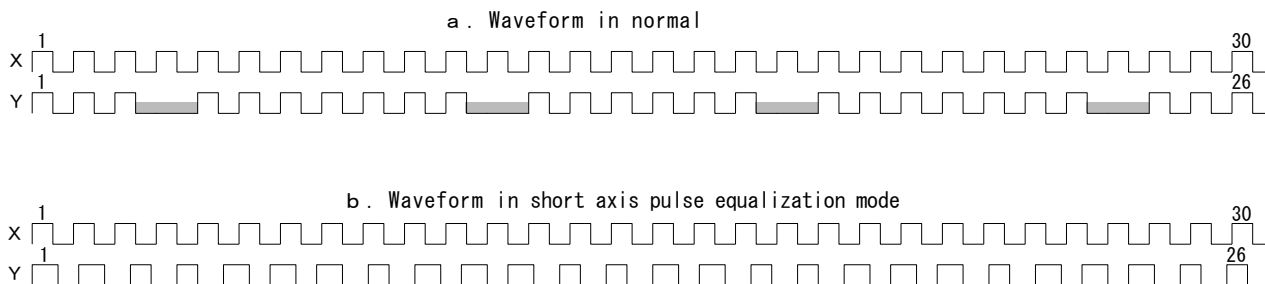

Fig. 3.6-1 Pulse Waveform in 2-axis Linear Interpolation (Finish point X:30, Y:26)

Short axis pulse equalization performs the interpolation calculation in the IC, enhancing by several times than usual. Because of that, the setting range of parameters is restricted by 1/8 as shown in the table below. When enabling short axis pulse equalization mode, be sure to perform interpolation driving within the range of the following table.

Table 3.6-1 Setting Range of Parameters in Short Axis Pulse Equalization

Parameter	Symbol	Settable Range	
		Short axis pulse equalization : Enabled	Usual
Drive speed	DV	1~1,000,000	1~8,000,000
Initial speed	SV	1~1,000,000	1~8,000,000
Acceleration/Deceleration	AC, DC	1~67,108,863	1~536,870,911
Finish point	TP	-134,217,728~+134,217,728	-1,073,741,823~+1,073,741,823
Center point of arc	CP	-134,217,728~+134,217,728	-1,073,741,823~+1,073,741,823

3.6.1 Short Axis Pulse Equalization Setting

Short axis pulse equalization can be set by D8 bit of interpolation mode setting command (2Ah).

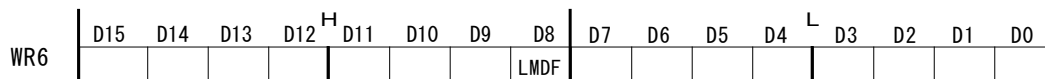

When 1 is set, short axis pulse equalization is enabled, and when 0 is set, it is disabled.

3.6.2 Notes on Using Short Axis Pulse Equalization

- Short axis pulse equalization cannot be used in the following driving.
 - ① S-curve acceleration/deceleration driving
 - ② Multichip interpolation
 - ③ Single step interpolation
 - ④ BP interpolation
 - ⑤ Continuous interpolation driving
 - ⑥ Comparing operation of current drive speed using a multi-purpose register
 - ⑦ Synchronous action that sets the current speed of driving and acceleration / deceleration to a multi-purpose register

- When Short axis pulse equalization is used in circular interpolation or helical interpolation, and if the start and finish points of a circular arc are not on the X or Y axis, the finish points of both axes may deviate by ± 1 pulse. And this deviation may be accumulated in helical interpolation. For this reason, in this case the user needs to fully consider whether this deviation will be a problem or not.
When the start and finish points of a circular arc are on the X or Y axis, this deviation does not occur.

3.7 Continuous Interpolation

Continuous interpolation is the operation that performs a series of interpolation processes such as linear interpolation → circular interpolation → linear interpolation → ⋯. This can only be performed when the number of the axis that executes continuous interpolation is the same, and it is possible to perform continuous interpolation as shown in the table below.

Table 3.7-1 Executable Continuous Interpolation

Executable Continuous Interpolation	Operation
Continuance of 2-axis linear interpolation	2-axis linear → 2-axis linear → 2-axis linear → ⋯
Continuance of 2-axis linear interpolation and circular interpolation	2-axis linear → Circular → 2-axis linear → 2-axis linear → Circular → ⋯
Continuance of 3-axis linear interpolation	3-axis linear → 3-axis linear → 3-axis linear → ⋯
Continuance of 4-axis linear interpolation	4-axis linear → 4-axis linear → 4-axis linear → ⋯

Continuous interpolation is achieved by pre-buffer. Before starting interpolation or during interpolation driving, set interpolation data to pre-buffer, and continuous interpolation driving will be performed. The user can set interpolation data of 8 segments to pre-buffer at a maximum.

3.7.1 How to Perform Continuous Interpolation

To perform continuous interpolation, set interpolation data to pre-buffer in advance and then start interpolation driving. The user can set interpolation data of 8 segments to pre-buffer at a maximum before starting interpolation. After starting interpolation, MCX514 achieves continuous interpolation by setting next interpolation data (segment data) to pre-buffer while checking the value of the stack counter.

The operation procedures to perform continuous interpolation are as follows.

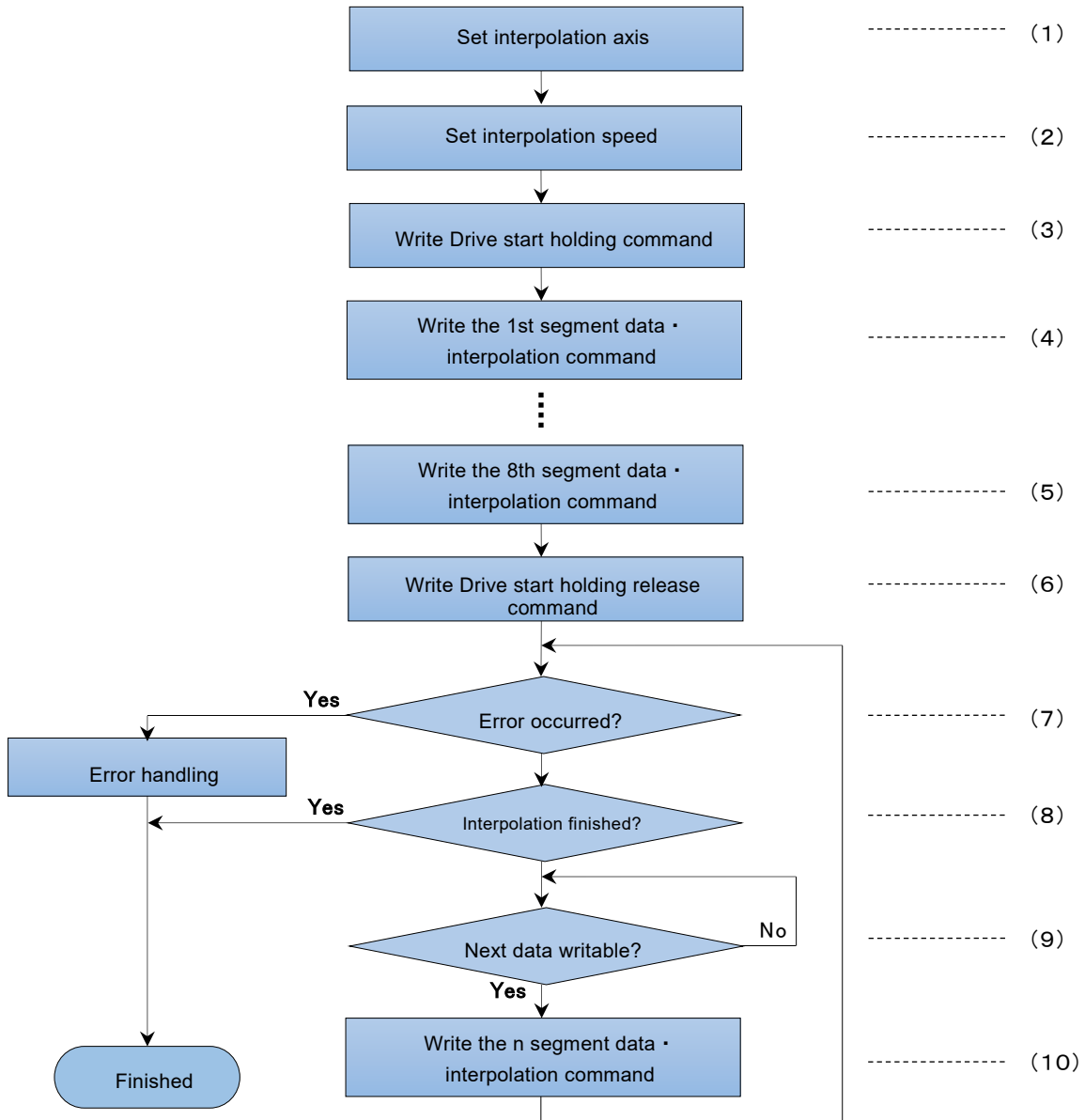

Fig. 3.7-1 The Flow of Continuous Interpolation

(1) Interpolation Axis Setting

Interpolation axis can be set by interpolation mode setting command (2Ah). As shown below, set D0~D3 bits of WR6 register, set 1 to the bit corresponding to the axis that interpolation is performed.

WR6	D15	D14	D13	D12 ^H	D11	D10	D9	D8	D7	D6	D5	D4 ^L	D3	D2	D1	D0
													U-EN	Z-EN	Y-EN	X-EN

- After starting interpolation, interpolation axis cannot be changed.
- The other bits (D15~D4) of WR6 register are the setting bit related to interpolation. Please refer to 7.3.8, and set appropriate values.

(2) Interpolation Speed Setting

It sets the drive speed for interpolation to the main axis among interpolation axes. The drive speed can be set up to 4MPPS at a maximum. When the user performs continuous interpolation at constant speed during all segments, set the same speed as initial speed with drive speed.

(3) Write Drive start holding command

It writes drive start holding command (77h) to the main axis. Once drive start holding command (77h) is written, driving cannot be started by issuing interpolation driving command. This enables to set interpolation data of 8 segments to pre-buffer at a maximum before starting interpolation.

(4) Write the 1st segment data and interpolation command

When the 1st segment is linear interpolation, write a finish point to each interpolation axis and then write linear interpolation driving command. When is circular interpolation, write the center point of a circular arc and a finish point to each interpolation axis and then write circular interpolation driving command.

When writing one segment information, any of a finish point, center point or interpolation axis can be written first; however, interpolation driving command must be written last.

(5) Write up to the 8th segment data and interpolation command

It writes data and interpolation driving command from the second up to the 8th segment as the 1st segment.

Pre-buffer is composed of 8 stages. While checking the value of the stack counter displayed in D12~D15 bits of RR0 register, the user can write data up to 8 segments before starting interpolation.

(6) Write Drive start holding release command

After writing interpolation data of segments that is necessary for pre-buffer, write drive start holding release command (78h) to the main axis. Interpolation driving starts at this timing.

(7) Error check

D4~D7 bits (X~UERR) of RR0 register displays the error status of the interpolation axis. When an error occurs, the corresponding bit becomes 1 and interpolation driving stops. These bits are checked and if an error does not occur, it will proceed to next procedure. For more details of the error bit of RR0 register, see RR2 register in chapter 6.13.

RR0	D15	D14	D13	D12 ^H	D11	D10	D9	D8	D7	D6	D5	D4 ^L	D3	D2	D1	D0
	HSTC3	HSTC2	HSTC1	HSTC0	CNEXT	ZONE2	ZONE1	ZONE0	U-ERR	Z-ERR	Y-ERR	X-ERR	U-DRV	Z-DRV	Y-DRV	X-DRV

(8) Check termination of interpolation

Check whether all segments are written or not, and if not, it will proceed to next procedure.

(9) Check writable of next data

D12~D15 bits (HSTC0~3) of RR0 register are assigned to the value of the stack counter in 8 stages of pre-buffer, and it displays the accumulation amount of the buffer. When the value of 4 bits is 0, it indicates an empty state, and when it is 8, it indicates a full state and cannot write segment data anymore. When interpolation driving command is written, the stack counter is counted up by 1 and when driving currently being output is finished, the stack counter is counted down by 1.

D11 bit (CNEXT) of RR0 register notifies the writable state of next data for continuous interpolation. After interpolation driving starts, CNEXT bit becomes 1 while the stack counter of pre-buffer is from 1 to 7. And during 1 of this bit, the host CPU determines that it is possible to write next data.

(10) Write the n segment data and interpolation command

It writes the data after the 9th segment during interpolation driving. The data is the same as the 1st to 8th segments described in (4) and (5). After writing interpolation driving command, it will return to (7).

3.7.2 Continuous Interpolation by Using Interrupt

Continuous interpolation can be performed by using interrupt. When pre-buffer has free space, INT1N signal (pin number: 34) becomes Low active and notifies the writable state of next segment data to the host CPU.

There are 2 kinds of the interruption timing that notifies the free space.

■ Interpolation interrupt setting

The interruption that notifies the free space can be set by 2 bits D14, D15 of interpolation mode setting command (2Ah).

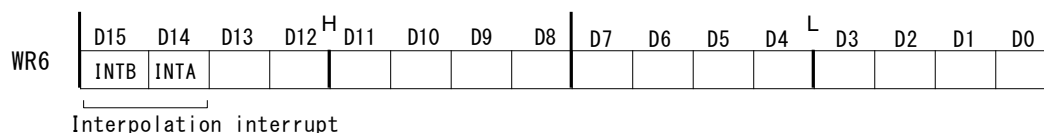

When D14 bit (INTA) is set as 1, and when the stack counter of pre-buffer changes from 4 to 3, INT1N signal becomes Low active. It notifies that about half of 8 stages of pre-buffer is empty. This is suitable for when continuous interpolation driving is performed relatively slowly.

When D15 bit (INTB) is set as 1, and when the stack counter of pre-buffer changes from 8 to 7, INT1N signal becomes Low active. It notifies that one is free in pre-buffer. This is suitable for when continuous interpolation driving is performed at high speed.

■ Interrupt processing

When an interrupt is generated by INT1N signal, the host CPU writes the necessary next segment data in interrupt processing routine. The data is the same as the 1st to 8th segments described in (4) and (5). At the end of one segment data, interpolation driving command must be written. The user can write while checking the value of the stack counter by D15~D12 bits (HSTC3~0) of RR0 register.

■ Clear Interrupt signal (INT1N)

INT1N signal is cleared automatically by writing the next interpolation driving command and then returns to hi-Z. Or it can be cleared by the following operation.

- Write interpolation interrupt clear command (6Fh)
- Continuous interpolation driving is finished.

3.7.3 Errors during Continuous Interpolation

There are 2 types of errors occurred during continuous interpolation: the error such as limit over run, and the writing error of interpolation data.

■ Error such as limit over run

When an error occurs such as limit over run during continuous interpolation, driving stops at the current interpolation segment. If stopped by an error, the stack counter of pre-buffer becomes 0, and the segment data after the data already written and interpolation command will be all disabled. It cannot proceed after clearing the error.

■ Data writing error

The writing error of interpolation data is occurred when it failed to set the data of next segment after the current interpolation segment.

In continuous interpolation, when the writing of the next segment data before the falling edge (positive logic) of the last pulse of interpolation driving in the last segment, and interpolation driving command are completed, there is no problem. While driving this segment after the falling edge of the last pulse, if interpolation driving command for next segment is written, the data cannot be handled. At this time, the segment will not be executed and the stack counter of pre-buffer will not be counted. D7 bit (interpolation error) of the main axis RR2 register becomes 1 and interpolation driving is terminated by the error. This error can be cleared by issuing error/finishing status clear command (79h) to all the interpolation axes after checking that interpolation drive stops.

3.7.4 Attention for Continuous Interpolation

- Set the necessary data such as finish point for each interpolation segment first, and then set interpolation driving command. Otherwise, it does not work properly.
- The maximum drive speed is 4MPPS (when in CLK=16MHz) in continuous interpolation.
- The time to drive all the interpolation segments should be longer than that for error checking and the data and command setting of next segment. The next interpolation segment must be loaded before the current interpolation segment is finished. When the current interpolation segment is finished before loading, and if driving command of next interpolation segment is written, it stops and then performs continuous interpolation. However, when the writing error of interpolation data (interpolation error) occurs, continuous interpolation is terminated.
- In continuous interpolation, the user cannot set the data that does not output pulses such as the finish points of all axes for linear interpolation or the center points of both axes for circular interpolation are 0. If set, interpolation cannot be performed appropriately.
- When circular interpolation is included in continuous interpolation, circular interpolation may have $\pm 1\text{LSB}$ error of the short axis value of finish point from true value. Be sure to make continuous interpolation not to accumulate errors of each segment, checking each circular finish point. It is impossible to perform the different axis number of continuous interpolation like from 3-axis to 2-axis.
- Interpolation axis cannot be changed during continuous interpolation.
- When driving is stopped by an error, be sure to check the error type, and clear the error by issuing error/finishing status clear command (79h) after checking that interpolation drive stops. Interpolation driving cannot be performed unless the error is cleared.
- When driving is stopped by stop command during continuous interpolation, the segment data set to pre-buffer will be all disabled.
- Bit pattern interpolation and helical interpolation cannot be configured together with other interpolation in continuous interpolation driving.
- When changing the drive speed during continuous interpolation driving, it can be changed by synchronous action.

3.7.5 Example of Continuous Interpolation

Fig. 3.7-2 shows an example of continuous interpolation started at the point (0, 0) from segment S1 to S21, which is configured with 2-axis linear interpolation and circular interpolation. Circular interpolation is a quarter of a circle with the radius 500 and 1000, interpolation speed: 1000PPS at constant speed in 2-axis high accuracy constant vector speed mode. It supposes that the segment S1 starts at the point (X0, Y6000). The following table shows the interpolation command of each segment and setting data.

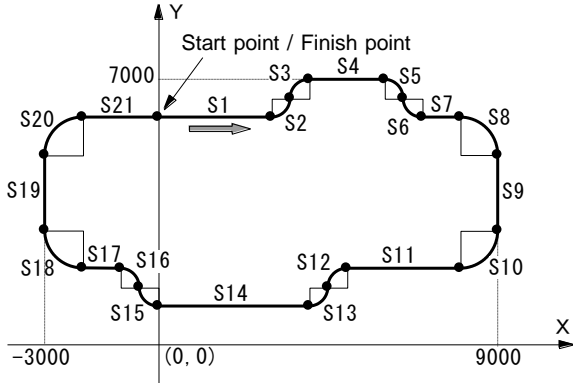

Fig. 3.7-2 Example of Continuous Interpolation

Segment Number	Command	Finish point X	Finish point Y	Center point X	Center point Y
S1	2-axis linear	3000	0		
S2	CCW circular	500	500	0	500
S3	CW circular	500	500	500	0
S4	2-axis linear	2000	0		
S5	CW circular	500	-500	0	-500
S6	CCW circular	500	-500	500	0
S7	2-axis linear	1000	0		
S8	CW circular	1000	-1000	0	-1000
S9	2-axis linear	0	-2000		
S10	CW circular	-1000	-1000	-1000	0
S11	2-axis linear	-3000	0		
S12	CCW circular	-500	-500	0	-500
S13	CW circular	-500	-500	-500	0
S14	2-axis linear	-4000	0		
S15	CW circular	-500	500	0	500
S16	CCW circular	-500	500	-500	0
S17	2-axis linear	-1000	0		
S18	CW circular	-1000	1000	0	1000
S19	2-axis linear	0	2000		
S20	CW circular	1000	1000	1000	0
S21	2-axis linear	2000	0		

```
//--- Set interpolation axis / mode ----
WR6 ← 00C3h Write ; Set X, Y axes,
                    2-axis high accuracy
constant
                    vector speed mode
WR0 ← 002Ah Write

//--- Set interpolation drive speed -----
WR6 ← 03E8h Write ; 1000 PPS
WR7 ← 0000h Write
WR0 ← 0104h Write ; Set initial speed to main axis (X)

WR6 ← 03E8h Write ; 1000 PPS
WR7 ← 0000h Write
WR0 ← 0105h Write ; Set drive speed to main axis

//--- Drive start holding -----
WR0 ← 0177h Write ; Drive start holding to main axis

//--- Set Segment1 2-axis linear ----
WR6 ← 0BB8h Write ; Finish point X : 3000
WR7 ← 0000h Write
WR0 ← 0106h Write ; Finish point setting command
WR6 ← 0000h Write ; Finish point Y : 0
WR7 ← 0000h Write
WR0 ← 0206h Write
WR0 ← 0061h Write ; 2-axis linear interpolation command

//--- Set Segment2 CCW circular ----
WR6 ← 01F4h Write ; Finish point X : 500
WR7 ← 0000h Write
WR0 ← 0106h Write
WR6 ← 01F4h Write ; Finish point Y : 500
WR7 ← 0000h Write
WR0 ← 0206h Write
WR6 ← 0000h Write ; Center point X : 0
WR7 ← 0000h Write
WR0 ← 0108h Write
WR6 ← 01F4h Write ; Center point Y : 500
WR7 ← 0000h Write
WR0 ← 0208h Write
WR0 ← 0065h Write ; CCW circular interpolation command
```

```
//--- Set Segment3 CW circular -----
WR6 ← 01F4h Write      ; Finish point X : 500
WR7 ← 0000h Write
WR0 ← 0106h Write
WR6 ← 01F4h Write      ; Finish point Y : 500
WR7 ← 0000h Write
WR0 ← 0206h Write
WR6 ← 01F4h Write      ; Center point X : 500
WR7 ← 0000h Write
WR0 ← 0108h Write
WR6 ← 0000h Write      ; Center point Y : 0
WR7 ← 0000h Write
WR0 ← 0208h Write
WR0 ← 0064h Write      ; CW circular interpolation command
```

Similarly, set Segment4~8.

```
//--- Drive start holding release -----
WR0 ← 0178h Write      ; Write Drive start holding release command to main axis
                          ; Interpolation driving is started

Set 9 to the segment counter SegCounter

Loop:
//---Error check -----
RR0 → Read              ; If RR0/D4 or D5 is 1, an error occurs. Go to error handling.

//--- Check termination of interpolation -----
                          ; If SegCounter is 22, continuous interpolation is terminated.

//--- Check writable of next data -----
RR0 → Read              ; If RR0/D11 is 1, it is writable and go to the next, and if = 0, read RR0 again.

//--- Write the next segment data -----
                          ; Write the segment data indicated by SegCounter and interpolation command

//---Go back to Loop -----
                          ; Count up SegCounter by 1 and jump to Loop.
```

3.8 Acceleration / Deceleration Control in Interpolation

Interpolation is usually performed in constant speed driving; however, MCX514 can perform interpolation also in linear acceleration / deceleration driving and S-curve acceleration / deceleration driving (linear interpolation only).

In interpolation driving, deceleration enabling (6Dh) and disabling (6Eh) commands are used to enable acceleration / deceleration driving in continuous interpolation.

Deceleration enabling command (6Dh) is to enable the automatic and manual deceleration in interpolation driving, and deceleration disabling command (6Eh) is to disable them. At reset, they are disabled. When the user performs single interpolation driving at acceleration / deceleration, be sure to enable the deceleration enabling before the start of driving. If deceleration enabling command is written during driving, it cannot be enabled.

3.8.1 Acceleration / Deceleration for Linear Interpolation

It is possible to perform trapezoidal and S-curve acceleration/deceleration driving in linear interpolation. Either automatic or manual deceleration can be used for decelerating.

When using the manual deceleration, set the maximum absolute value among the finish points of each axis coordinates as the manual deceleration point of the main axis. For instance, when 3-axis linear interpolation is performed with main axis: X, second axis: Y, third axis: Z and finish point (X:-20000, Y:30000, Z:-50000), if the pulse number necessary for deceleration is 5000, the maximum absolute value will be the finish point of Z axis, and so the user should set $50000-5000=45000$ as the manual deceleration point of the main axis: X.

For more details of examples of acceleration/deceleration driving in linear interpolation, see chapter 3.1 examples of linear interpolation.

[Note]

- S-curve acceleration/deceleration driving cannot be used in short axis pulse equalization mode.

3.8.2 Acceleration / Deceleration for Circular Interpolation and Bit Pattern Interpolation

In circular interpolation and bit pattern interpolation, only trapezoidal driving using manual deceleration is available, and S-curve driving and automatic deceleration cannot be used.

The figure on the right side shows the circular interpolation of a true circle with radius 10000 in a trapezoidal driving.

The user should calculate the manual deceleration point before driving because the automatic deceleration cannot be used in circular interpolation.

In the figure, the circle tracks through all the 8 quadrants: 0~7. In quadrant 0, Y axis is the short axis and its displacement is about $10000 / \sqrt{2}=7071$. The total output pulses number of the short axis is $7071 \times 8 = 56568$.

If the initial speed is 500PPS and accelerated to 20KPPS in 0.3 SEC, the acceleration will be $(20000-500) / 0.3 = 65000\text{PPS/SEC}$. And the output pulses during acceleration will be $(500+20000) \times 0.3/2 = 3075$. Thus, if we set the deceleration as well as the acceleration, the manual deceleration point will be $56568 - 3075 = 53493$.

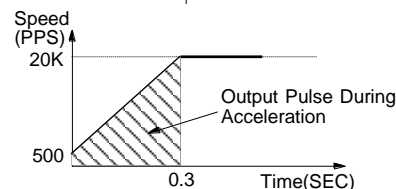
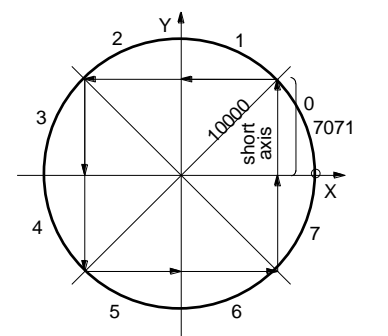

[Note]

- This formula is not applied to constant vector speed mode.

```

WR0 ← 011Fh Write      ; Select X axis
WR3 ← 0001h Write      ; Deceleration start point : Manual

WR6 ← 0003h Write      ; Set interpolation mode : Specify X, Y axes
WR0 ← 002Ah Write

WR6 ← FDE8h Write      ; Acceleration : 65000 PPS/SEC
WR7 ← 0000h Write
WR0 ← 0102h Write

```

```
WR6 ← 01F4h Write      ; Initial speed : 500 PPS
WR7 ← 0000h Write
WR0 ← 0104h Write

WR6 ← 4E20h Write      ; Drive speed : 20000 PPS
WR7 ← 0000h Write
WR0 ← 0105h Write

WR6 ← D8F0h Write      ; Center point X : -10000
WR7 ← FFFFh Write
WR0 ← 0108h Write

WR6 ← 0000h Write      ; Center point Y : 0
WR7 ← 0000h Write
WR0 ← 0208h Write

WR6 ← 0000h Write      ; Finish point X : 0
WR7 ← 0000h Write
WR0 ← 0106h Write

WR6 ← 0000h Write      ; Finish point Y : 0
WR7 ← 0000h Write
WR0 ← 0206h Write

WR6 ← D0F5h Write      ; Manual deceleration point : 53493
WR7 ← 0000h Write
WR0 ← 0107h Write

WR0 ← 006Dh Write      ; Deceleration enabling

WR0 ← 0065h Write      ; CCW circular interpolation driving
```



3.8.3 Acceleration / Deceleration for Continuous Interpolation

In continuous interpolation, same as in circular and bit pattern interpolations, only trapezoidal driving using manual deceleration is available, and S-curve driving and automatic deceleration cannot be used.

Before performing the continuous interpolation, it is necessary to preset the manual deceleration point, which is related to the basic pulse of the main axis output in the start segment of deceleration.

When setting interpolation data for the start segment of deceleration, write deceleration enabling command before writing the interpolation command. When driving enters the segment that deceleration is enabled, the deceleration is enabled. And when the output pulses that are counted from the start of the segment are larger than the manual deceleration point, deceleration will start. The deceleration can be performed across segments.

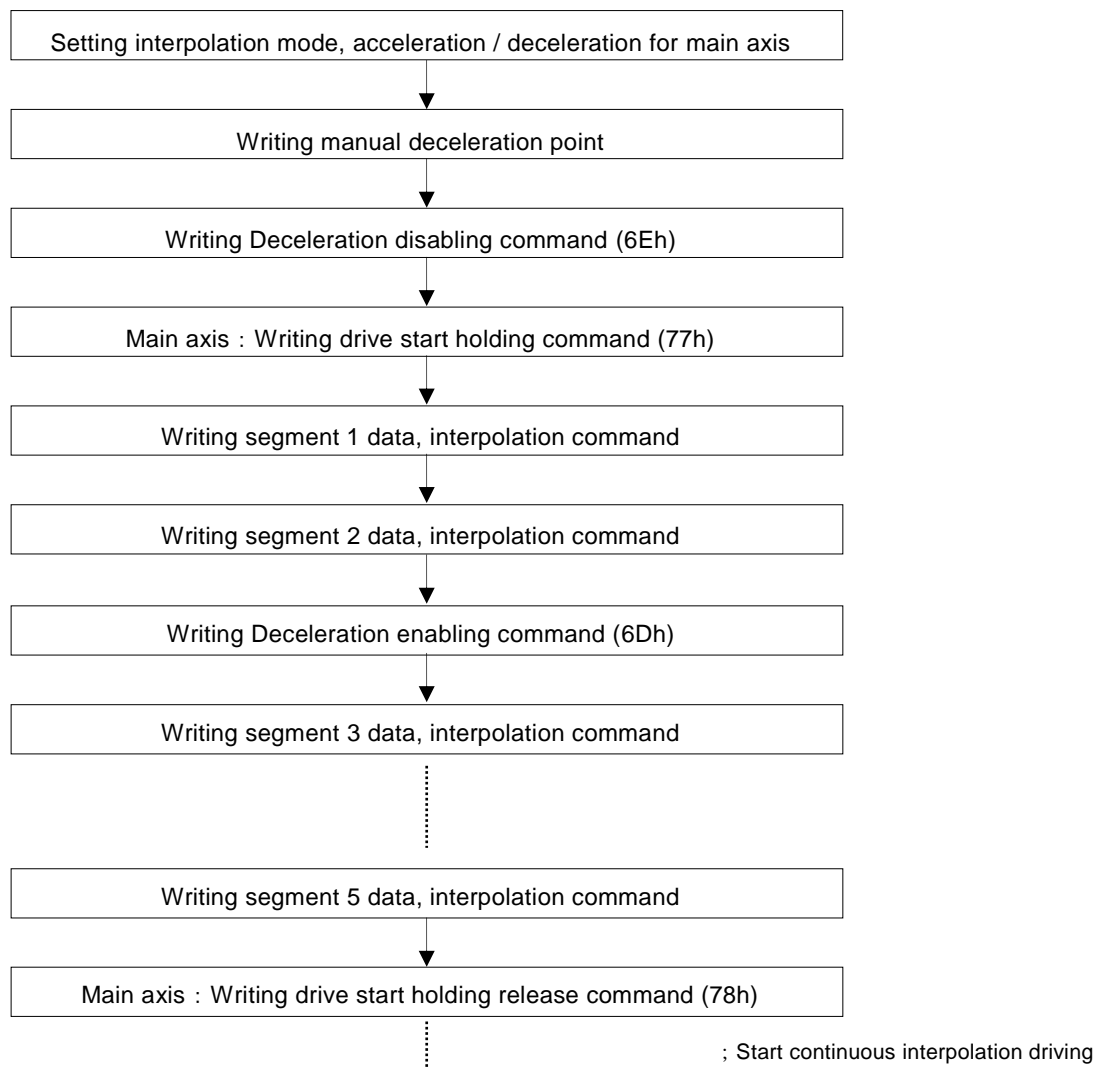
For instance, to start the manual deceleration from the segment 3 in continuous interpolation with segments from 1 to 5, the procedures are shown as follows:



In this case, please note the manual deceleration point is the value for the output pulses of the main axis that are counted from the start of the segment 3.

3.9 Single-step interpolation

Single-step is defined as: pulse by pulse outputting. Either command or external signal can execute the single-step interpolation. By using external signal, interpolation driving can be performed in synchronization with an external signal, but the basic pulse of the main axis.

When using single-step, interpolation main axis must be set with constant speed driving. The Hi level width of the output pulse from each axis is 1/2 of the pulse cycle which is decided by drive speed of interpolation main axis. The Low level width is kept until next command or external signal comes. Fig. 3.9-1 is the example of single-step interpolation by an external signal. The main axis initial speed is 500PPS, the drive speed is 500PPS at constant speed driving. The Hi level width of the output pulse is 1mSEC. (positive logic)

Set 1 bit to D9 by interpolation mode setting command (2Ah), and it will enable the single-step interpolation mode.

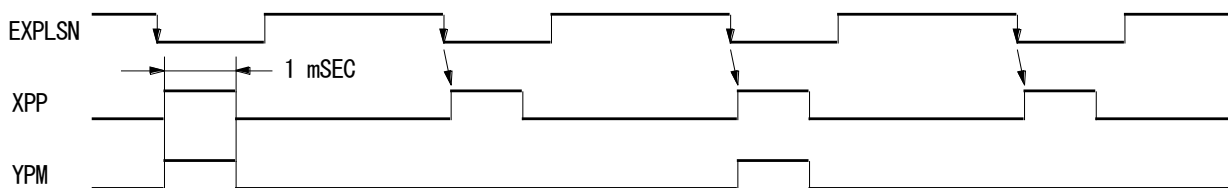
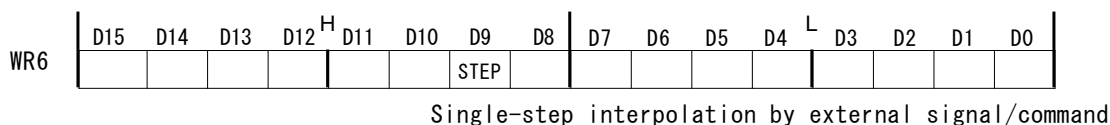

Fig. 3.9-1 Example of Single-step Interpolation (500PPS) by External Signal (EXPLSN)



3.9.1 Command Controlled Single-step Interpolation

Interpolation step command (6Fh) is provided for single-step interpolation. The operating procedure is shown as follows.

- a. Set D9 bit to 1 by interpolation mode setting command (2Ah).
It will enable the single-step interpolation.
- b. Set the same value as the initial and drive speeds of interpolation main axis.
When the same value is set as the initial and drive speeds, driving becomes constant speed. This speed value must be faster than the writing cycle of single-step interpolation command. If the host CPU writes single step command at most 1mSEC, the user should set both speeds faster than 1000PPS.
- c. Set interpolation data. (finish point, center point...)
- d. Write interpolation command.
Although the interpolation segment is enabled, there is no pulse output because the single-step is command controlled.
- e. Write the single-step interpolation command (6Fh).
The driving pulses result from the interpolation calculation will be output from each axis. Interpolation step command (6Fh) is written until the interpolation driving is finished.

If the user wants to stop single-step interpolation on the way, write instant stop command (57h) to the main axis and wait for more than 1 pulse cycle, and then write interpolation step command (6Fh) again, driving will stop.

Interpolation step command written after the termination of interpolation driving will be disabled.

3.9.2 External Signal Controlled Single-step Interpolation

EXPLSN pin (30) is used for the single-step interpolation from the external signal.

Normally, EXPLSN input signal is on the Hi level. When it changes to Low, the interpolation step will be output.

The operating procedure is shown as follows.

- a. Set D9 bit as 1 by interpolation mode setting command (2Ah).
It will enable the single-step interpolation.
- b. Set the same value as the initial and drive speeds of interpolation main axis.
When the same value is set as the initial and drive speeds, driving becomes constant speed. This speed value must be faster than the Low pulse cycle of EXPLSN as well as the case of the command.
- c. Set interpolation data. (finish point, center point...)
- d. Write interpolation command.
Although the interpolation segment was written, the interpolation pulses are not output yet, because the single-step interpolation is enabled.
- e. EXPLSN input on Low level
The interpolation pulse will be output after 2~5 CLK from the EXPLSN falling down.

The Low level pulse width of EXPLSN has to be longer than 4CLK. Furthermore, the pulse cycle of EXPLSN has to be longer than the setting speed cycle of the main axis.

The Low level pulse of EXPLSN is repeated until the interpolation driving is finished.

If the user wants to stop single-step interpolation on the way, write instant stop command (57h) to the main axis and wait for more than 1 pulse cycle, and then input the Low level pulse of EXPLSN again, driving will stop. (Or the user can software reset.)

The Low level pulse of EXPLSN input after the termination of interpolation driving will be disabled.

3.9.3 Attention for Single-step Interpolation

- ESPLSN signal does not have the filter function. When generating Low pulses of EXPLSN at a mechanical contact point, prevent the malfunction caused by chattering.
- In single-step interpolation, short axis pulse equalization mode cannot be used.

3.10 Multichip Interpolation

This is the function that performs multiple axes linear interpolation by using multiple IC chips.

Fig. 3.10-1 shows the connection example of 12 axes linear interpolation with 3 chips. Since the main chip plays a role to send the synchronous pulse for interpolation driving, set the interpolation speed parameter to the main axis in the main chip.

As shown in the figure, 8 signals for multichip interpolation (MPLS, MCLK, MERR, MINP, MDT3~0) are each connected among chips, and pull up with impedance of about 3.3KΩ. These signals cannot be used as general purpose input because they are shared with the general purpose input signals (PIN7~0).

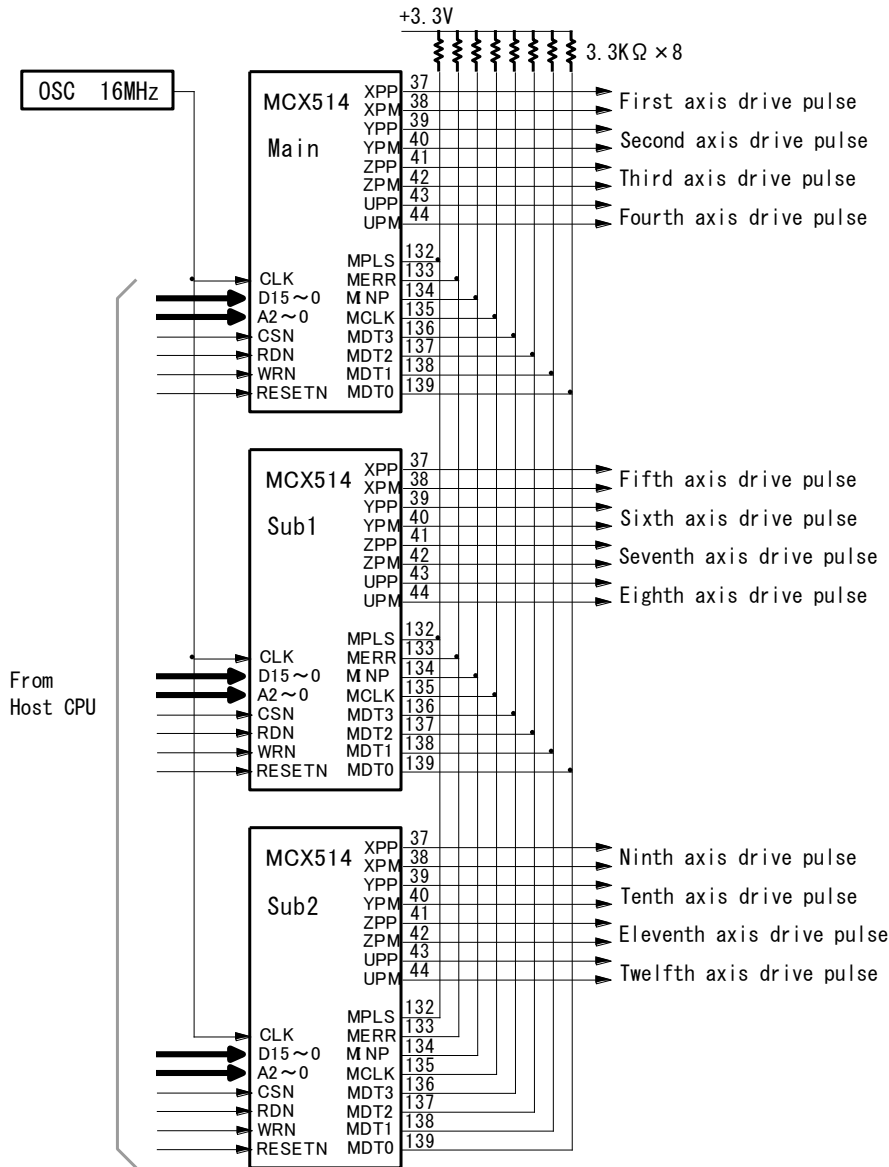

Fig. 3.10-1 The Connection Example of Multichip Axes Interpolation

Each signal works as follows.

Table 3.10-1 Operation of Each Signal in Multichip Interpolation

Signal (Pin No.)	Signal Function	Direction	Shared General Purpose Input Signal
MPLS(132)	Synchronous pulse of interpolation drive	Main → Sub	PIN7
MERR(133)	Error occurred / Stop of main chip	Main ↔ Sub	PIN6
MINP(134)	In-position waiting	Main ← Sub	PIN5
MCLK(135)	Clock of data transfer for MDT3~0	Main ↔ Sub	PIN4
MDT3~0(136~139)	Transfer data of finish point in each chip	Main ↔ Sub	PIN3~0

3.10.1 Execution Procedure

The execution procedure of multiple axes linear interpolation by using multiple IC chips is as follows.

(1) Designation of multichip main/sub and interpolation axis

It specifies the main or sub chip and the execution axis of interpolation in each chip by interpolation mode setting command (2Ah). Set the prescribed bit of WR6 register, and interpolation mode setting command will be executed by writing the command code 2Ah to WR0 register. Please set other bits of WR6 register corresponding to interpolation mode as needed.

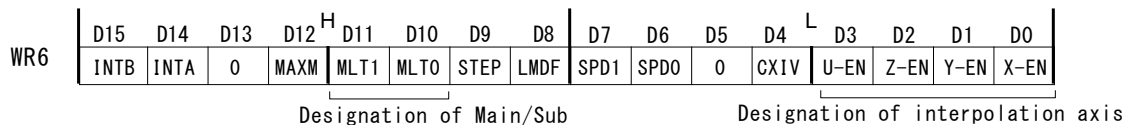

Use D10, 11 bits (MLT0, 1) to specify the main or sub chip.

Table 3.10-2 Designation of Chip for Multichip Interpolation

D11(MLT1)	D10(MLT0)	Designation of Main / Sub chip
0	0	Not perform multichip interpolation
0	1	Perform multichip interpolation as main chip
1	0	Perform multichip interpolation as sub chip
1	1	Invalid (cannot be set)

Use D3~D0 bits of WR6 register to specify the execution axis of interpolation in each chip. When set 1 to the corresponding bit, it is enabled as interpolation axis.

Table 3.10-3 Designation of Axis for Multichip Interpolation

Bit of WR6	Interpolation Axis	
D0(X-EN)	X	0 : Disable interpolation 1 : Enable interpolation
D1(Y-EN)	Y	
D2(Z-EN)	Z	
D3(U-EN)	U	

In multichip interpolation, the user can also specify 1 axis only.

[Note]

- In multichip interpolation, short axis pulse equalization mode cannot be used. Be sure to set D8bit as 1.

(2) Speed parameter setting for the main axis of the main chip

It sets the speed parameters to the main axis of the main chip for interpolation driving. There is no need to set to other interpolation axes of the main and sub chips. The following parameters must be set to the main axis of the main chip based on the acceleration/deceleration.

Table 3.10-4 Speed Parameters for the Main Axis of Main Chip

Acceleration/Deceleration	○: need to set				
	Speed parameters for the main axis of main chip				
	Jerk	Acceleration	Deceleration	Initial Speed	Drive Speed
Constant speed driving				○	○
Trapezoidal driving		○		○	○
Non-symmetry trapezoidal driving		○	○	○	○
S-curve symmetry driving	○	○		○	○

[Note]

- The maximum drive speed is 4MPPS in multichip interpolation. Set the drive speed lower than 4MPPS.
- The setting drive speed is applied to the axis that has the maximum number of the drive pulse in all axes of multiple axes linear interpolation. The setting speed is not necessarily applied to the main axis of the main chip.
- When performing trapezoidal or S-curve acceleration/deceleration driving, deceleration enabling command (6Dh) must be written to the main chip before interpolation driving command.

(3) Finish point setting of each axis

Write a finish point to all of each axis that performs interpolation with main/sub chips, by the relative value from the current value. The finish point range of multichip interpolation is signed 28-bit. Write the finish point data to WR6, 7 register, and then write the command code 06h with axis assignment to WR0 register, and they will be set.

Generally, when multiple axes linear interpolation is performed, the maximum value of finish point data in all axes is required in calculating linear interpolation for each axis. In order to enable high-speed continuous linear interpolation, this IC generates the maximum value automatically when a finish point of each axis is set. There is no need to calculate the maximum value by CPU and to set the maximum value to each axis.

When finish point data is written in the axis of some chip, it is transferred from the written chip to other chips through multichip interpolation signal (MCLK, MDT3~0). In the receiving chip, when the finish point data is received, the data is **compared** with the maximum finish point of its own chip by absolute value, and when the data is larger, the maximum finish point will be updated. This transfer time of finish point data takes about 2μsec (CLK=16MHz). Therefore an interval of writing of finish point for each axis cannot be shortened than this time. In high-speed calculation CPU, if a writing cycle of finish point data is faster than this time, it is necessary to input delay in the software.

The maximum finish point is cleared to 0 when resetting or immediately after starting interpolation driving command. Also it can be cleared by the maximum finish point clear command (7Ch). And the maximum finish point can be read by the interpolation / finish point maximum value reading command (39h), the user can confirm whether the maximum value is correctly generated after writing finish point data of all axes.

[Note]

- The value read by the interpolation / finish point maximum value reading command (39h) is different before and after interpolation driving. For more details of interpolation / finish point maximum value reading command (39h), see chapter 7.4.10.

■ Finish point data transfer error

In the receiving chip of finish point data, it checks whether there is an error in the data sum and transfer frame or not. If it is not correctly received, an error occurs, and D7 bit (CERR) of RR2 register and D12 bit (MCERR) of RR3 register Page1 become 1. In addition, all error bits (the corresponding bits of D7~4:n-ERR) of RR0 register in interpolation axes become 1. When a receiving error occurs in the sub chip, the error is sent through multichip interpolation signal (MERR) to the main chip, and the error bit of the main axis RR0 register in the main chip also becomes 1.

(4) Writing of interpolation command

Write the linear interpolation driving command (60h~63h) corresponding to the number of interpolation axis in each sub chip. Then, write the linear interpolation driving command (60h~63h) corresponding to the number of interpolation axis in the main chip. If the command is written to the main chip first, it does not work properly. When performing acceleration/deceleration driving, the deceleration enabling command (6Dh) must be written to the main chip before the interpolation driving command.

Table 3.10-5 Multichip Interpolation Command

Interpolation Command	Code
1-axis linear interpolation driving	60h
2-axis linear interpolation driving	61h
3-axis linear interpolation driving	62h
4-axis linear interpolation driving	63h

When the linear interpolation driving command (60h~63h) is written to the main chip, the main chip starts immediately to output the synchronous pulse of interpolation driving to each sub chip through MPLS signal, and then linear interpolation starts in all axes.

(5) Termination of driving, Error check

During interpolation driving, the drive bits (D3~0 : n-DRV) of interpolation axis become 1 in RR0 register of each chip. The user can check the termination of driving whether the drive bit of the main axis returns to 0 in the main chip.

When in-position is enabled in each axis, the drive bits (D3~0 : n-DRV) of the main axis return to 0 in RR0 register of the main chip after waiting for enabled nINPOS signals of all axes to become active.

When an error occurs in any axis of the main chip during interpolation driving, one of D5~0 bits becomes 1 in RR2 register of each axis, and the error bit (D7~4 : n-ERR of a corresponding axis) become 1 in RR0 register.

And when an error occurs in any axis of the sub chip, similarly to the main chip, one of D5~0 bits becomes 1 in RR2 register of each axis, and the error bit (D7~4 : n-ERR of a corresponding axis) become 1 in RR0 register. And the sub chip makes MERR signal of multichip interpolation signal Low Active, and informs the main chip about an error occurring. In the main chip, when the error is received, the error bit (D7~4 : n-ERR of a corresponding axis) of the main axis become 1 in RR0 register. If an error occurs, the main chip stops outputting the synchronous pulse of interpolation driving to the sub chip; as a result, all axes stop immediately. Thus, the user just monitors the error bit (D7~4 : n-ERR) of RR0 register in the main axis of the main chip to check an error during interpolation and at the termination of driving. If the error is detected (bit data = 1), check the data of RR2 register (register for displaying error) of each interpolation axis, and perform error analysis.

3.10.2 Stop of Interpolation Driving

When the user wants to stop interpolation driving, write the stop command to the main axis of the main chip. When driving of the main axis stops, other interpolation axes of main and sub chips also stop driving, and the drive bit (corresponding bit of D3~0:n-DRV) of RR0 register returns to 0.

3.10.3 Continuous Interpolation

Linear interpolation driving can be performed continuously in multichip interpolation too, by the same way as the continuous interpolation with single chip. Write the drive start holding command and drive start holding release command to the main axis of the main chip. If pre-buffer of the main chip has free space, the user can write the finish point data into all the interpolation axes. The empty state of pre-buffer in the sub chip will be updated at the same timing as the main chip.

3.10.4 Notes for Multichip Interpolation

- Multichip interpolation signal (MPLS,MCLK,MERR,MINP,MDT3~0) must be pulled up to 3.3V, the range of a resistance value is 1K~5.1KΩ. It is recommended to use about 3.3KΩ.
- Do not cross the wiring path of multichip interpolation signal (MPLS, MCLK, MERR, MINP, MDT3~0) with other signals, and connect them as short as possible, and cannot share the general input signal by jumper switching in customer's circuit system.
- In multichip interpolation, constant vector speed can be performed only with axes of the main chip.
- In-position should be set disabled in continuous interpolation.

3.10.5 Examples of Multichip Interpolation

Examples using 2 chips: main and sub chips are as follows.

■ Example 1 Multichip Interpolation with each chip of 2-axis X and Y

【Program Example】

```

// Interpolation mode setting of main and sub chips
// Writing to main chip
WR6 ← 0403h Write           // Main chip  Designation of X,Y Interpolation axis
WR0 ← 002Ah Write
// Writing to sub chip1
WR6 ← 0803h Write           // Sub chip   Designation of X,Y Interpolation axis
WR0 ← 002Ah Write
// Writing to sub chip2
WR6 ← 0803h Write           // Sub chip   Designation of X,Y Interpolation axis
WR0 ← 002Ah Write

//Driving parameters setting to main axis of main chip (2M PPS constant speed driving)
WR6 ← 1200h Write           // Initial speed  8M PPS (maximum in specification)
WR7 ← 007Ah Write
WR0 ← 0104h Write

WR6 ← 8480h Write           // Drive speed  2M PPS
WR7 ← 001Eh Write
WR0 ← 0105h Write

// Writing of finish point data and Receiving error check
// Writing to main chip
WR6 ← 0014h Write           // Finish point1 X  20
WR7 ← 0000h Write
WR0 ← 0106h Write
// Receiving error check of sub chip1           Handling A
RR0 / D4,D5 Read
If D4,D5=1, jump to ERROR(sub chip) // Go to error handling
// Receiving error check of sub chip2           Handling B
RR0 / D4,D5 Read
If D4,D5=1, jump to ERROR(sub chip) // Go to error handling
WR6 ← 000Ah Write           // Finish point1 Y  10
WR7 ← 0000h Write
WR0 ← 0206h Write
// Execute the handling A
// Execute the handling B

// Writing to sub chip1
WR6 ← FFF6h Write           // Finish point1 X  -10
WR7 ← FFFFh Write
WR0 ← 0106h Write
// Receiving error check of main chip           Handling C
RR0 / D4,D5 Read
If D4,D5=1, jump to ERROR(main chip) // Go to error handling
// Execute the handling B
WR6 ← 0005h Write           // Finish point1 Y  5
WR7 ← 0000h Write
WR0 ← 0206h Write
// Execute the handling C
// Execute the handling B

// Writing to sub chip2
WR6 ← 0019h Write           // Finish point1 X  25
WR7 ← 0000h Write
WR0 ← 0106h Write
// Execute the handling C
// Execute the handling A
WR6 ← FFF4h Write           // Finish point1 Y  -12
WR7 ← FFFFh Write
WR0 ← 0206h Write
// Execute the handling C
// Execute the handling A

```



```

// Write interpolation command in the order of sub chip and main chip
// Writing to sub chip1
WR0 ← 0061h Write           // 2-axis linear interpolation
// Writing to sub chip2
WR0 ← 0061h Write           // 2-axis linear interpolation
// Writing to main chip
WR0 ← 0061h Write           // 2-axis linear interpolation
// ERROR handling (main chip)
WR0 ← 011Fh Write           // Error check of interpolation in RR2 register, to any of interpolation axes (Example: X)
RR0 / D4,5 Read             // Error check of interpolation axes
RR2 / D7 Read               // Interpolation error check
WR0 ← 017Bh Write           // Write RR3 Page1 display command, to any of interpolation axes (Example: X)
RR3 / D12 Read              // Error check of multichip interpolation transfer error

WR0 ← 0179h Write           // Write error clear command to interpolation axes
RR0 / D4,5 Read             // Error clear check of interpolation axes
RR2 / D7 Read               // Error clear check of interpolation
RR3 / D12 Read              // Error clear check of multichip interpolation transfer error

// ERROR handling (sub chip)
WR0 ← 011Fh Write           // Error check of interpolation in RR2 register, to any of interpolation axes (Example: X)
RR0 / D4,5 Read             // Error check of interpolation axes
RR2 / D7 Read               // nterpolation error check
WR0 ← 017Bh Write           // Write RR3 Page1 display command, to any of interpolation axes (Example: X)
RR3 / D12 Read              // Error check of multichip interpolation transfer error
// Reading RR0 register of main chip
RR0 / D4 Read               // Error check of main axis in main chip

WR0 ← 0179h Write           // Write error clear command to interpolation axes
RR0 / D4,5 Read             // Error clear check of interpolation axes
RR2 / D7 Read               // Error clear check of interpolation
RR3 / D12 Read              // Error clear check of multichip interpolation transfer error
// Reading RR0 register of main chip
RR0 / D4 Read               // Error clear check of main axis in main chip

```

■ Example 2 Continuous Interpolation in Multichip Interpolation

The following example A, B, C and ERROR handling are the same as Example 1.

【Program Example】

```

// Interpolation mode setting of main and sub chips
// Writing to main chip
WR6 ← 0403h Write           // Main chip  Designation of X,Y Interpolation axis
WR0 ← 002Ah Write
// Writing to sub chip1
WR6 ← 0803h Write           // Sub chip   Designation of X,Y Interpolation axis
WR0 ← 002Ah Write
// Writing to sub chip2
WR6 ← 0803h Write           // Sub chip   Designation of X,Y Interpolation axis
WR0 ← 002Ah Write

// Driving parameters setting to main axis of main chip (2M PPS constant speed driving)
WR6 ← 1200h Write           // Initial speed  8M PPS (maximum in specification)
WR7 ← 007Ah Write
WR0 ← 0104h Write

WR6 ← 8480h Write           // Drive speed  2M PPS
WR7 ← 001Eh Write
WR0 ← 0105h Write

// Write drive start holding command to main axis of main chip
WR0 ← 0177h Write

// Writing of finish point data and Receiving error check
// Seg1
// Writing to main chip
WR6 ← 0014h Write           // Finish point1 X  20
WR7 ← 0000h Write
WR0 ← 0106h Write
// Execute the handling A
// Execute the handling B
WR6 ← 000Ah Write           // Finish point1 Y  10
WR7 ← 0000h Write
WR0 ← 0206h Write
// Execute the handling A
// Execute the handling B

// Writing to sub chip1
WR6 ← FFF6h Write           // Finish point1 X  -10
WR7 ← FFFFh Write
WR0 ← 0106h Write
// Execute the handling C
// Execute the handling B
WR6 ← 0005h Write           // Finish point1 Y   5
WR7 ← 0000h Write
WR0 ← 0206h Write
// Execute the handling C
// Execute the handling B

// Writing to sub chip2
WR6 ← 0019h Write           // Finish point1 X  25
WR7 ← 0000h Write
WR0 ← 0106h Write
// Execute the handling C
// Execute the handling A
WR6 ← FFF4h Write           // Finish point1 Y  -12
WR7 ← FFFFh Write
WR0 ← 0206h Write
// Execute the handling C
// Execute the handling A

// Write interpolation command in the order of sub chip and main chip
// Writing to sub chip1
WR0 ← 0061h Write           // 2-axis linear interpolation
// Writing to sub chip2
WR0 ← 0061h Write           // 2-axis linear interpolation

```

```

// Writing to main chip
WR0 ← 0061h Write // 2-axis linear interpolation

// Seg2
// Writing to main chip
WR6 ← 000Ah Write // Finish point1 X 10
WR7 ← 0000h Write
WR0 ← 0106h Write
// Execute the handling A
// Execute the handling B
WR6 ← 0014h Write // Finish point1 Y 20
WR7 ← 0000h Write
WR0 ← 0206h Write
// Execute the handling A
// Execute the handling B

// Writing to sub chip1
WR6 ← 0005hWrite // Finish point1 X 5
WR7 ← 0000hWrite
WR0 ← 0106h Write
// Execute the handling C
// Execute the handling B
WR6 ← 000Ah Write // Finish point1 Y 10
WR7 ← 0000h Write
WR0 ← 0206h Write
// Execute the handling C
// Execute the handling B

// Writing to sub chip2
WR6 ← 0019h Write // Finish point1 X 25
WR7 ← 0000h Write
WR0 ← 0106h Write
// Execute the handling C
// Execute the handling A
WR6 ← 000ChWrite // Finish point1 Y 12
WR7 ← 0000hWrite
WR0 ← 0206h Write
// Execute the handling C
// Execute the handling A

// Write interpolation command in the order of sub chip and main chip
// Writing to sub chip1
WR0 ← 0061h Write // 2-axis linear interpolation
// Writing to sub chip2
WR0 ← 0061h Write // 2-axis linear interpolation
// Writing to main chip
WR0 ← 0061h Write // 2-axis linear interpolation

// Repeat up to Seg8 as needed in the same way
.
.
.

// Write drive start holding command to main axis of main chip
WR0 ← 0178h Write // Starts continuous interpolation driving

```

4. I2C Serial Bus

This IC has I²C serial interface bus in addition to the existing 8-bit/16-bit data bus as the interface to connect a host CPU. I²C serial bus uses only 2 lines to transfer data: serial data line (SDA) and serial clock line (SCL). Three modes of data transfer rate are available: Standard mode (100Kbit/sec), Fast mode (400Kbit/sec) and Fast mode plus (1Mbit/sec) when the load capacity of the bus is 400pF or less. Compared with 8-bit/16-bit data bus, the data transfer efficiency is decreased by approximately 10 to 100 times; but it can be performed within 1~ a few mseconds from the setting of necessary parameters (drive speed, drive pulse number, etc.) up to the start of relative driving. This is very suitable bus interface for the system that does not require high-speed setup.

The following is the connection example of I²C serial bus.

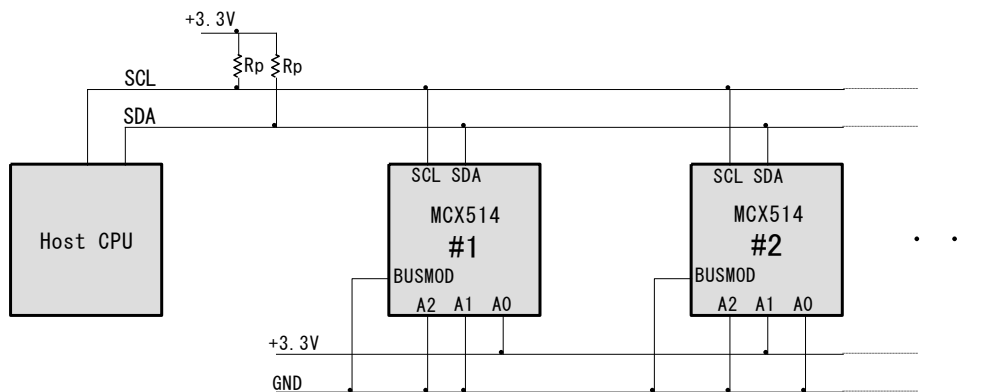

Fig. 4.1-1 The Connection Example of I²C Serial Bus

4.1 Pins used in I2C Bus Mode

To use MCX514 in I²C bus mode, it is necessary to connect the following pins correctly.

Table 4.1-1 Pins in I²C Bus Mode

Signal	Pin No.	Description
BUSMOD	32	Sets the bus mode. Setting Low level becomes in I2C bus mode.
A2~A0	22~24	Address signals A2~A0 (22~24) are used as chip address setting pins. Low level is 0, and Hi level is 1. MCX514 chips can be connected up to 8 chips at a maximum on the same bus.
SDA	25	SDA signal pin in I ² C bus, which must be pulled up.
SCL	26	SCL signal pin in I ² C bus, which must be pulled up. It is shared with CSN signal. When in I ² C bus mode, it is used as SCL signal input.
I2CRSTN	31	Reset signal for I ² C control section. Setting Low level in CLK asynchronous input will reset. Keep on Low 1μsec or more. It is shared with H16L8 signal.

4.1.1 Pull-up Resistor (Rp)

SDA and SCL signals of the bus line need pull-up resistor (Rp), and the value of pull-up resistor depends on the data transfer rate and load capacity of the bus. For more details, please refer to I2C bus specification from NXP.

4.1.2 I2CRSTN Reset

■ At initial setting

In the initial state of the system, noise may be occurred in SCL and SDA signals by switching I²C pin mode of the host CPU, and then the data transfer may not be performed correctly. In this case, please adjust the steps of I²C initial setting on the CPU side, in order to eliminate noise. If the noise is not reduced, the user needs to execute I²C Reset to MCX514 by using I2CRSTN signal after completion of I²C initial setting. Or, the user can reset the I²C control section by using RESETN signal that resets MCX514.

■ At data transfer

When I²C communication does not work correctly such as retuning Hi from an acknowledge signal, reset the I²C control section by I2CRSTN signal. Similarly to above, the user can use RESETN signal as substitution.

4.2 I2C Bus Transmitting and Receiving

From the host CPU to MCX514, the procedures of writing to WR register and reading from RR register are as follows.

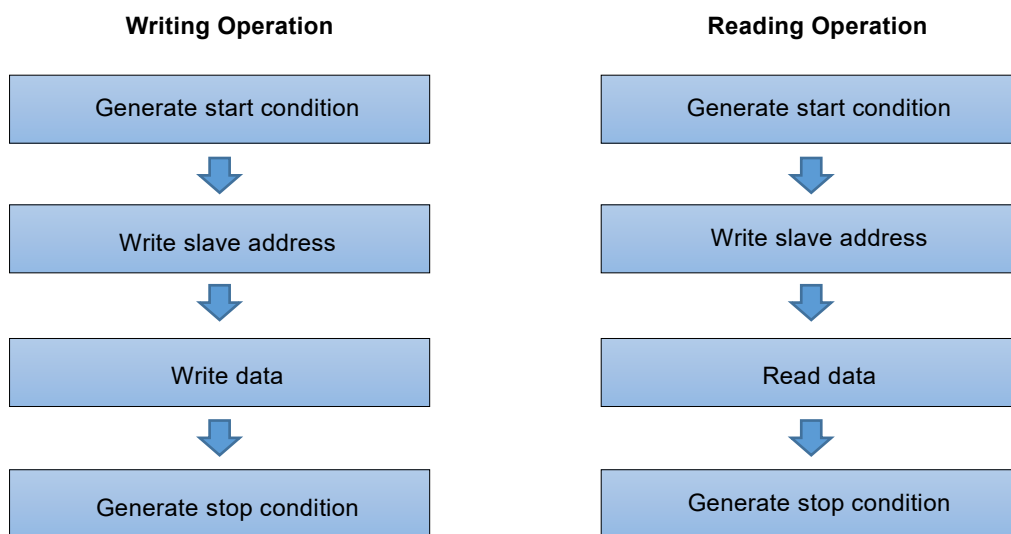

MCX514 has only slave function.

4.2.1 Writing Operation

MCX514 Writing procedures to WR register are described below.

■ **Generate start condition**

When SCL signal is Hi and SDA signal changes from Hi to Low, it becomes start condition. Whenever sending and receiving, the host CPU must generate this start condition at the beginning.

■ **Write slave address**

After making start condition, the user transmits an instruction whether to write from which WR register of which chip to MCX514. It transmits 8-bit slave address synchronized with SCL shown below, and receives ACK (Low) from MCX514 in the 9th bit. The slave address is composed of chip address of 3 bits D7~D5, register address of 4 bits D4~D1 and the bit D0 for reading / writing.

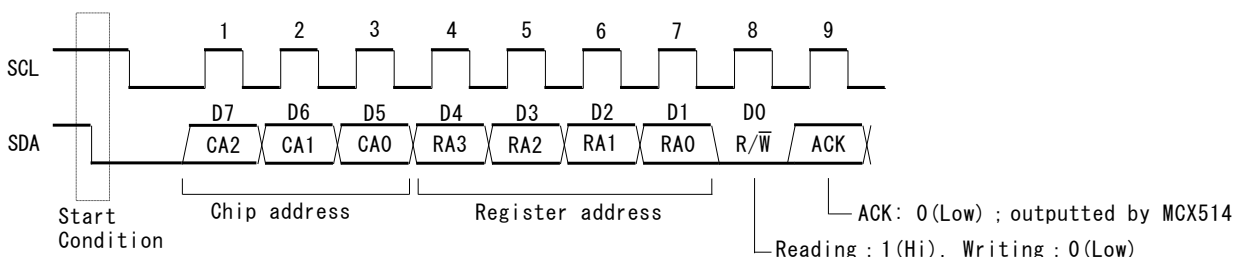

Fig. 4.2-1 Slave Address

Specify the address set by A2 (22), A1 (23), A0 (24) pins of MCX514 to CA2~CA0 of chip address. Low is 0 and Hi is 1. As for a register address, specify the register address that the user wants to write, referring to the following table. Although WR register is 16-bit configuration, but I²C data transfer must be specified in bytes.

Table 4.2-1 Register Address for Writing

Register Address				WRn Register
RA3	RA2	RA1	RA0	
0	0	0	0	WR0L
0	0	0	1	WR0H
0	0	1	0	WR1L
0	0	1	1	WR1H
0	1	0	0	WR2L
0	1	0	1	WR2H
0	1	1	0	WR3L
0	1	1	1	WR3H
1	0	0	0	WR4L
1	0	0	1	WR4H
1	0	1	0	WR5L
1	0	1	1	WR5H
1	1	0	0	WR6L
1	1	0	1	WR6H
1	1	1	0	WR7L
1	1	1	1	WR7H

WRnL is the low byte (D7~D0) of WRn.
 WRnH is the high byte (D15~D8) of WRn.

The last bit D0 for writing of slave address is the bit to designate reading / writing. When writing, set it to 0..

If the slave address is sent by 8SCL, MCX514 returns ACK to SDA signal in the 9th SCL. When it receives 8-bit slave address correctly, MCX514 corresponding to the chip address returns Low (open drain output is turned ON). When it is not received correctly or the chip addresses do not match, not return Low.

■ Write data

Then, perform data writing. The data for writing is transmitted from WRn register specified by the slave address, byte by byte. From only one byte to multiple bytes continuously can be written. In the 9th SCL after sending 1 byte, if MCX514 correctly receives, it returns ACK signal of Low level on the SDA line. When the CPU receives this ACK signal, then, sends 1 byte data to be written into the next register address.

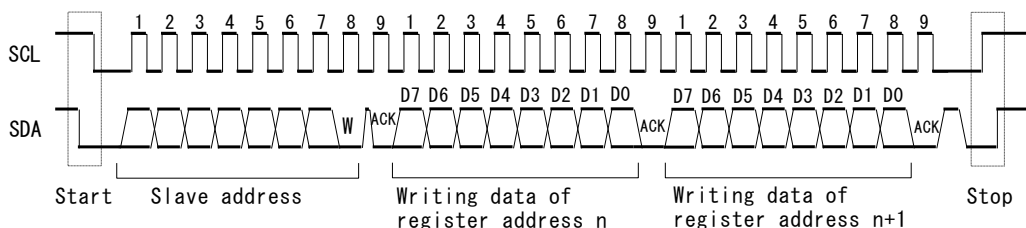

Fig. 4.2-2 Data Writing

■ Generate stop condition

To stop data writing, the user needs to generate stop condition. When SCL signal is Hi and SDA signal changes from Low to Hi, it becomes stop condition. Whenever sending and receiving, the host CPU must generate this stop condition at the end.

4.2.2 Reading Operation

MCX514 Reading procedures from RR register are described below.

■ Generate start condition

When SCL signal is Hi and SDA signal changes from Hi to Low, it becomes start condition. Whenever sending and receiving, the host CPU must generate this start condition at the beginning.

■ Write slave address

After making start condition, the user transmits an instruction whether to read from which RR register of which chip to MCX514. It transmits 8-bit slave address synchronized with SCL shown below, and receives ACK (Low) from MCX514 in the 9th bit. The slave address is composed of chip address of 3 bits D7~D5, register address of 4 bits D4~D1 and the bit D0 for reading / writing.

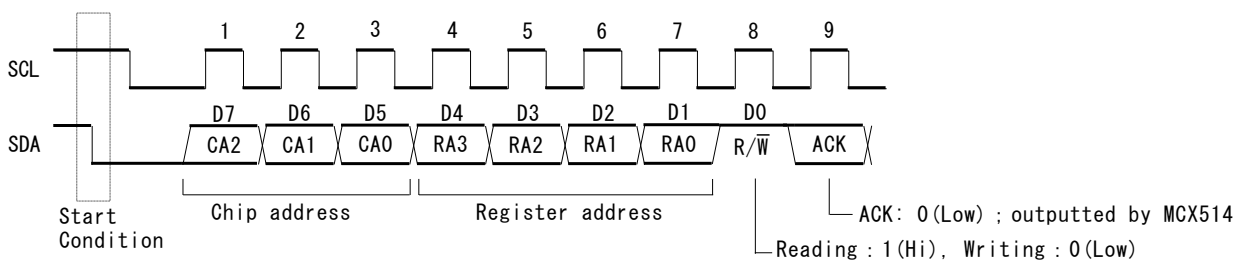

Fig. 4.2-3 Slave Address

Specify the address set by A2 (22), A1 (23), A0 (24) pins of MCX514 to CA2~CA0 of chip address. Low is 0 and Hi is 1. As for a register address, specify the register address that the user wants to read, referring to the following table. Although RR register is 16-bit configuration, but I²C data transfer must be specified in bytes.

Table 4.2-2 Register Address for Reading

Register Address				RRn Register
RA3	RA2	RA1	RA0	
0	0	0	0	RR0L
0	0	0	1	RR0H
0	0	1	0	RR1L
0	0	1	1	RR1H
0	1	0	0	RR2L
0	1	0	1	RR2H
0	1	1	0	RR3L
0	1	1	1	RR3H
1	0	0	0	RR4L
1	0	0	1	RR4H
1	0	1	0	RR5L
1	0	1	1	RR5H
1	1	0	0	RR6L
1	1	0	1	RR6H
1	1	1	0	RR7L
1	1	1	1	RR7H

RRnL is the low byte (D7~D0) of RRn.

RRnH is the high byte (D15~D8) of RRn.

The last bit D0 for writing of slave address is the bit to designate reading / writing. When reading, set it as 1.

If the slave address is sent by 8SCL, MCX514 returns ACK to SDA signal in the 9th SCL. When it receives 8-bit slave address correctly, MCX514 corresponding to the chip address returns Low (open drain output is turned ON). When it is not received correctly or the chip addresses do not match, not return Low.

■ Read data

Then, perform data reading. The data for reading is outputted from RRn register specified by the slave address on the SDA line, byte by byte. From only one byte to multiple bytes continuously can be read. In the 9th SCL after receiving 1 byte, if the CPU correctly receives, it is necessary to return ACK signal of Low level on the SDA line. However, in the last data that comes stop condition next, return ACK signal of Hi level.

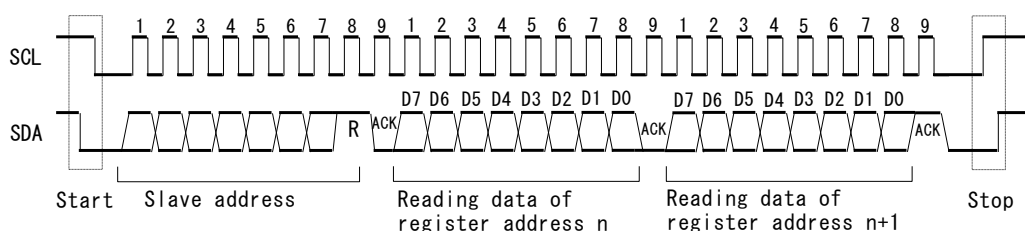

Fig. 4.2-4 Data Reading

■ Generate stop condition

To stop data reading, the user needs to generate stop condition. When SCL signal is Hi and SDA signal changes from Low to Hi, it becomes stop condition. Whenever sending and receiving, the host CPU must generate this stop condition at the end.

4.2.3 Notes on Using I2C Serial Bus

- When writing to WR0 register, the high byte (H) must be written first, followed by the low byte (L). The user cannot write 2 bytes continuously. It is necessary to set and write each slave address individually. If the low byte is written, the command is executed immediately to the axis prior specified.
- When reading data, as for ACK signal at reading of the last data, the CPU must return Hi level of ACK signal on the SDA line. If returns Low level, this IC cannot terminate communication correctly.
- When using interrupt related to INT0N signal, the user cannot read RR0H. If reads RR0H, the interrupt related to INT0N signal may be cleared. If the user needs to read RR0H when using interrupt, please contact us.
- When reading RR1 register, be sure to read 2 bytes (RR1L, RR1H) from RR1L. If reads only 1 byte of RR1L, the interrupt of RR1H may be cleared.
- Repeat start condition is not available.

4.2.4 Connection Example

The connection example of this IC with CPU is as follows.

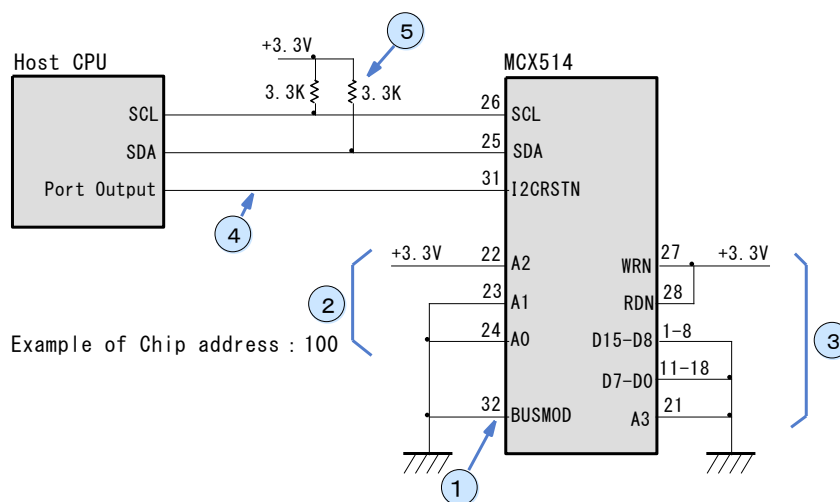

- ① Fix BUSMOD to GND, and set I²C bus mode.
- ② Determine chip address by A2, A1, A0 signals.
- ③ Fix parallel bus signal (floating input) to GND or VCC.
- ④ Connect I2CRSTN as necessary, which is not needed unless noise is occurred on the SCL, SDA line from the CPU side at initial setting.
- ⑤ Pull-up resistors are essential on the SCL, SDA lines.

4.2.5 Control Example

The following three examples show the flow of controlling the IC using I2C serial bus. The user can download sample programs for controlling each type of CPU including these three examples, from our web site: <http://www.novaelec.co.jp/>

- (1) Write command
- (2) Write data
- (3) Read data

(1) Write command

To write a command, the user needs to write an execution axis and command to WR0 register. At this time, if the low byte of WR0L is written, a command will be executed immediately. So the user needs to specify the axis before issuing a command. As shown below, specify an axis at ①, and then write a command at ②.

- ① Write an axis assignment to WR0H.

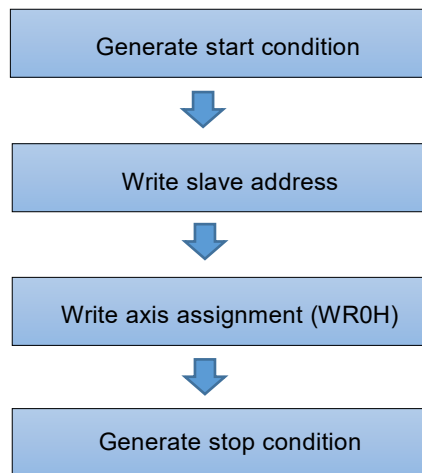

- ② Write a command to WR0L

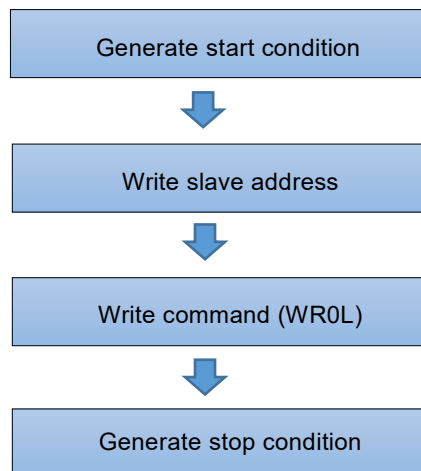

(2) Write data

To perform data writing such as parameter settings, write parameters to WR6, WR7 registers and then write an axis assignment and command to WR0 register. Regarding writing of WR0 register, as described in (1) Write command, a command must be written after the axis assignment.

① Write data to WR6, 7

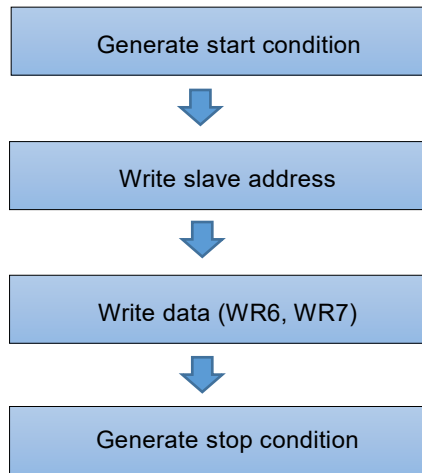

② Write axis assignment to WR0H

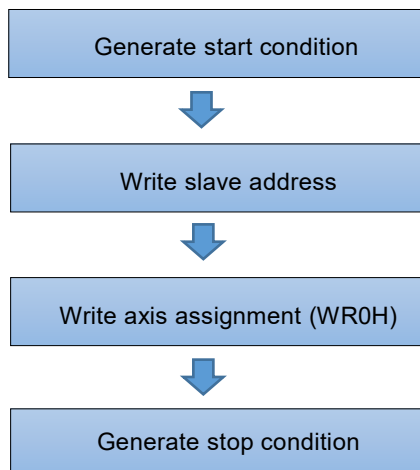

③ Write data writing command to WR0L

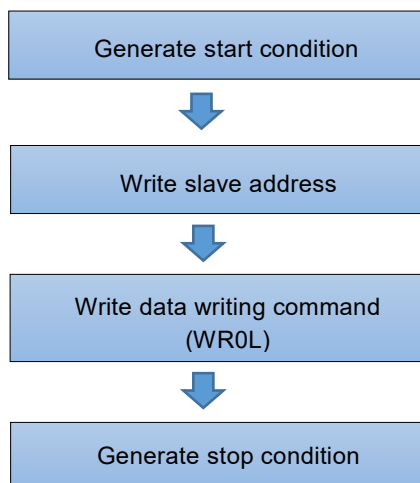

(3) Read data

To perform data reading, write an axis assignment and command to WR0 register, and then read RR6, RR7 registers. Regarding writing of WR0 register, as described in (1) Write command, a command must be written after the axis assignment.

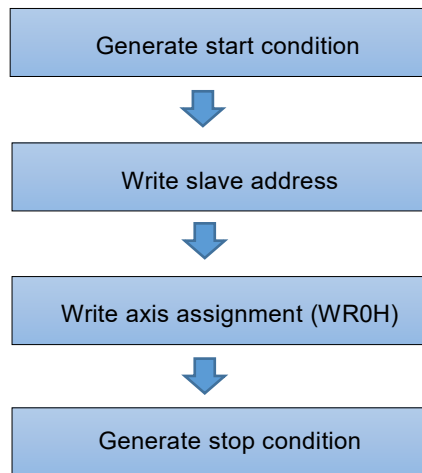
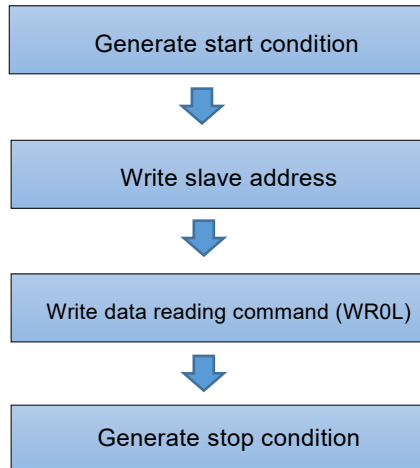
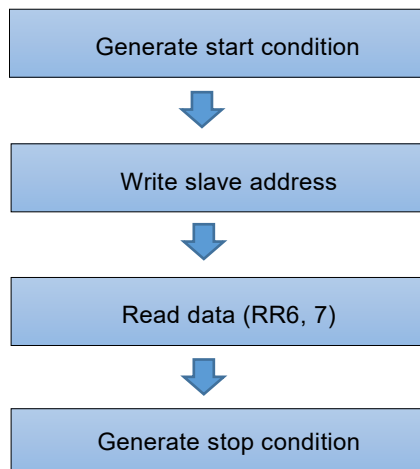
① Write axis assignment to WR0H**② Write data reading command to WR0L****③ Read from RR6, 7**

5. Pin Assignments and Signal Description

5.1 Pin Assignments

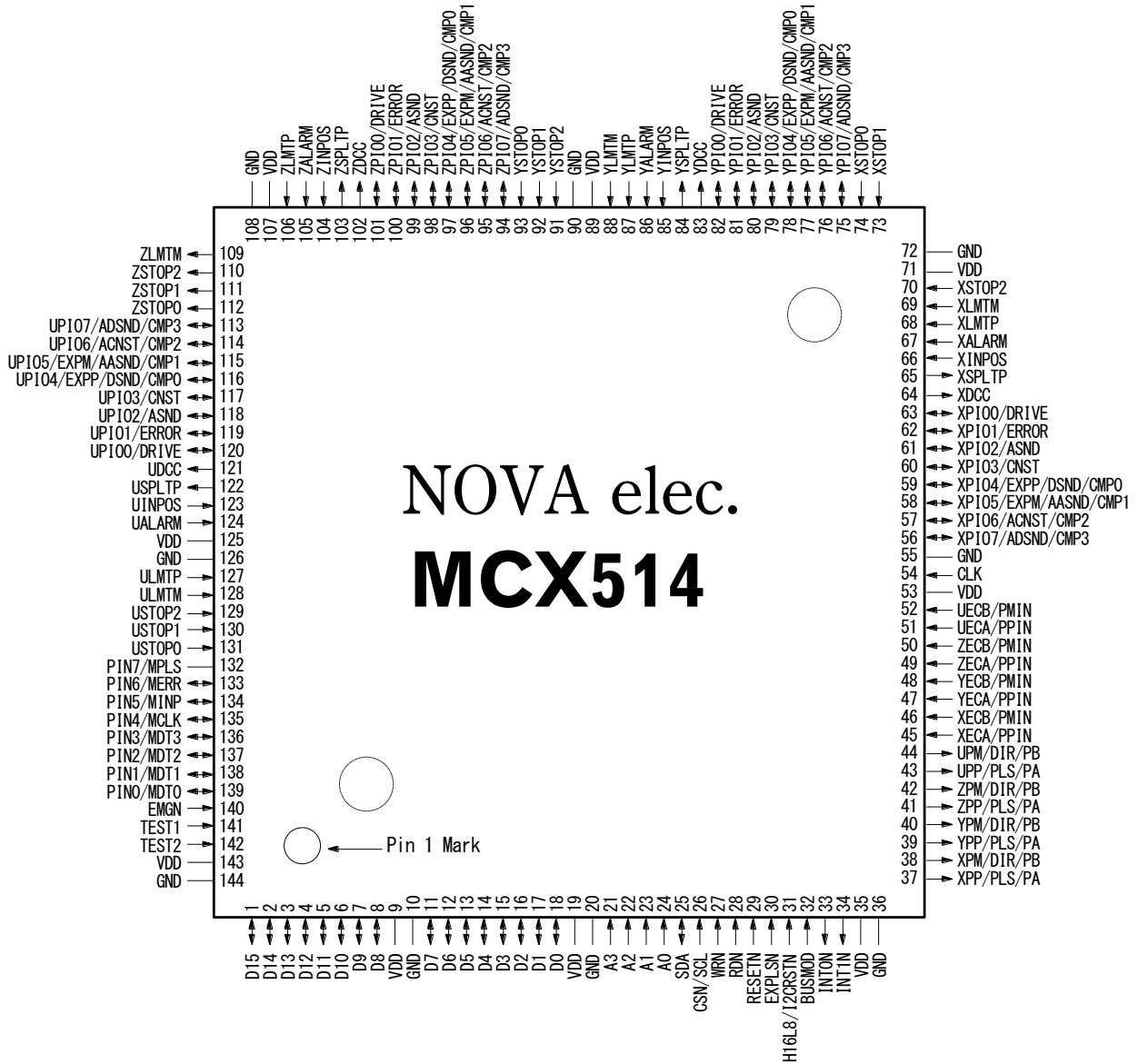

See chapter 12 for the 144-pin plastic QFP package: 20×20mm, external package: 22×22mm, pin pitch: 0.5mm

5.2 Signal Description

See chapter 5.3 for description of input/output logic. The input signals with – F – symbol indicates that an integral filter circuit is available in the internal input column of this IC.

Signal Name	Pin No.	Input/Output	Signal Description
CLK	54	Input A	Clock: clock signal for internal synchronous loop of MCX514 This signal is for drive speed, acceleration/deceleration and acceleration/deceleration increasing rate. If the frequency setting is not 16 MHz, the setting values of speed and acceleration / deceleration are different.
D15~D0	1~8, 11~18	Bi-directional A	Data Bus (D15~D0): 3-state bi-direction 16-bit data bus When CSN=Low and RDN=Low, these signals are for outputting. Otherwise, they are high impedance inputs. If 8-bit data bus is used and D15~D8 are not used, they should be connected to VDD or GND through high impedance (about 10K~100 kΩ). In I ² C mode, can be used as general purpose input signals.
A3~A0	21~24	Input A	Address: address signal for the host CPU to access the write / read registers If 16-bit data bus is used, A3 cannot be used and should be connected to GND. In I ² C mode, A2~A0 are used as chip address setting pins.
SDA	25	Bi-directional D	I2CSDA: SDA signal in I ² C mode.
CSN/SCL	26	Input A	Chip Select / I ² C SCL: input signal for selecting I/O device for MCX514 Set the Low level for data reading and writing. In I ² C mode, used as SCL signal.
WRN	27	Input A	Write Strobe: its level is Low while data is being written to MCX514. While WRN is Low, CSN and A3~A0 must be determined. Around when WRN is up (↑), the levels of D15~D0 must be determined because the data is latched in the write register when WRN is up (↑).
RDN	28	Input A	Read Strobe: its level is Low while data is being read from MCX514. Set CSN at Low and RDN at Low, and while RDN is Low, the read register data selected by A3~A0 address signals is output to the data bus.
RESETN	29	Input A	Reset: reset (return to the initial setting) signal for MCX514. Setting RESETN at Low for more than 8 CLK cycles resets MCX514. This IC must be reset by RESETN signal when the power is on. [Note] If there is no clock input to MCX514, setting RESETN at Low cannot reset this IC
EXPLSN	30	Input B	External Pulse: pulse input signal for single-step interpolation by external signal. In single-step interpolation by external signal, EXPLSN down (↓) starts the interpolation calculation and 1 interpolation pulse of each axis is output. The width of EXPLSN on the Low level must be more than 4CLK. [Note] EXPLSN does not have the filter function.
H16L8 /I2CRSTN	31	Input B	Hi=16bit, Low=8bit: data bus width selection for 16-bit / 8-bit When set at Hi, 16-bit data bus is selected for processing the 16-bit data reading / writing in IC; when set at Low, 8-bit data bus (D7~D0) is active for data reading / writing. In I ² C mode, used as I ² C Reset. Setting Low resets the I ² C control section inside of the IC.
BUSMOD	32	Input B	Bus Mode: Selects CPU bus mode. When set at Hi, it is in 16bit / 8bit parallel bus mode, and when set at Low, it is in I ² C serial bus mode.
INT0N	33	Output B	Interrupt: outputs an interrupt signal to the host CPU. If any interrupt factor except interpolation pre-buffer generates an interrupt, INT0N becomes Low level. When an interrupt is released, it will return to the Hi-Z level.
INT1N	34	Output B	Interrupt: outputs an interrupt signal to the host CPU. If interrupt factor by interpolation pre-buffer generates an interrupt, INT1N becomes Low level. When an interrupt is released, it will return to the Hi-Z level.

Signal Name	Pin No.	Input/Output	Signal Description
XPP/PLS/PA YPP/PLS/PA ZPP/PLS/PA UPP/PLS/PA	37 39 41 43	Output A	Pulse + / Pulse / Pulse Phase A: + direction drive pulse outputting It is Low level at reset, and when driving is started, DUTY 50% (at constant speed) of the plus drive pulses is output. When the 1-pulse 1-direction mode is selected, this terminal is for drive output. When the quadrature pulse mode is selected, this terminal is for A-phase signal output.
XPM/DIR/PB YPM/DIR/PB ZPM/DIR/PB UPM/DIR/PB	38 40 42 44	Output A	Pulse - / Direction / Pulse Phase B: - direction drive pulse outputting It is Low level at reset, and when driving is started, DUTY 50% (at constant speed) of the plus drive pulses is output. When the 1-pulse 1-direction mode is selected, this terminal is the direction signal. When the quadrature pulse mode is selected, this terminal is for B-phase signal output.
XECA/PPIN YECA/PPIN ZECA/PPIN UECA/PPIN	45 47 49 51	Input B - F -	Encoder-A / Pulse+in: signal for encoder phase-A input This input signal, together with phase-B signal, will make the Up / Down pulse transformation to be the input count of real position counter. When the Up / Down pulse input mode is selected, this terminal is for UP pulses input. When the input pulse is up (↑), the real position counter is counted up.
XECB/PMIN YECB/PMIN ZECB/PMIN UECB/PMIN	46 48 50 52	Input B - F -	Encoder-B / Pulse-in: signal for encoder phase-B input This input signal, together with phase-A signal, will make the Up / Down pulse transformation to be the input count of real position counter. When the Up / Down pulse input mode is selected, this terminal is for DOWN pulses input. When the input pulse is up (↑), the real position counter is counted down.
XSTOP2~0 YSTOP2~0 ZSTOP2~0 USTOP2~0	70,73,74 91,92,93 110,111,11 2 129,130,13 1	Input B - F -	Stop2~0: input signal to perform decelerating / instant stop These signals can be used for HOME searching. When the filter function is disabled, the active pulse width must be 2CLK or more. Enable / disable and logical levels can be set for STOP2~STOP0. In automatic home search, STOP0 can be assigned to a near home search signal, STOP1 to a home signal and STOP2 to an encoder Z-phase signal. The signal status can be read from RR3 register Page0.
XLMT+ YLMT+ ZLMT+ ULMT+	68 87 106 127	Input B - F -	Over Run Limit +: signal of + direction over limit During the + direction drive pulse outputting, decelerating stop or instant stop will be performed once this signal is active. When the filter function is disabled, the active pulse width must be 2CLK or more. Enable / disable, decelerating stop / instant stop and logical levels can be set as commands. When the limit signal is enabled and this signal is in its active level during + direction driving, HLMT+ bit of RR2 register becomes 1. The signal status can be read from RR3 register Page0, and this signal can be used to search a home position.
XLMT- YLMT- ZLMT- ULMT-	69 88 109 128	Input B - F -	Over Run Limit -: signal of - direction over limit During the - direction drive pulse outputting, decelerating stop or instant stop will be performed once this signal is active. When the filter function is disabled, the active pulse width must be 2CLK or more. Enable / disable, decelerating stop/instant stop and logical levels can be set as commands. When the limit signal is enabled and this signal is in its active level during - direction driving, HLMT- bit of RR2 register becomes 1. The signal status can be read from RR3 register Page0, and this signal can be used to search the home position.
XINPOS YINPOS ZINPOS UINPOS	66 85 104 123	Input B - F -	Inposition: input signal for servo driver in-position Enable/disable and logical level can be set as commands. When enabled and after driving is finished, DRIVE bit of main status register returns to 0 after this signal becomes active. The signal status can be read from RR3 register Page0.

Signal Name	Pin No.	Input/Output	Signal Description
XALARM YALARM ZALARM UALARM	67 86 105 124	Input B – F –	Servo Alarm: input signal for servo driver alarm Enable/disable and logical level can be set as commands. When enabled and when changes to active level during the driving, ALARM bit of RR2 register becomes 1 and driving stops instantly. The signal status can be read from RR3 register Page0.
XPIO7/ADSND/CMP3 YPIO7/ADSND/CMP3 ZPIO7/ADSND/CMP3 UPIO7/ADSND/CMP3	56 75 94 113	Bi-directional B – F –	Universal Input Output7 / Acceleration Descend / Compare MR3: general purpose input / output signals (PIO7), acceleration decreasing status output signal (ADSND), MR3 comparison output (CMP3) share the same pin. The signal to use can be set as commands. General purpose input signal (PIO7) status can be read, XPIO7, YPIO7 from RR4 register and ZPIO7, UPIO7 from RR5 register. General purpose output signal (PIO7) can set Hi / Low by writing the 1/0 data, XPIO7, YPIO7 to WR4 register and ZPIO7, UPIO7 to WR5 register. For synchronous action, it can be used as the input signal of an activation factor. Acceleration decreasing status output (ADSND) becomes Hi while the driving command is executed and when acceleration decrease. MR3 comparison output (CMP3) becomes Hi when it satisfies the comparison condition of multi-purpose register MR3.
XPIO6/ACNST/CMP2 YPIO6/ACNST/CMP2 ZPIO6/ACNST/CMP2 UPIO6/ACNST/CMP2	57 76 95 114	Bi-directional B – F –	Universal Input Output6 / Acceleration Constant / Compare MR2: general purpose input / output signals (PIO6), acceleration constant status output signal (ACNST), MR2 comparison output (CMP2) share the same pin. The signal to use can be set as commands. About general purpose input / output signals (PIO6), it is the same as PIO7. For synchronous action, it can be used as the input signal of an activation factor. Acceleration constant status output (ACNST) becomes Hi while the driving command is executed and when acceleration keeps constant. MR2 comparison output (CMP2) becomes Hi when it satisfies the comparison condition of multi-purpose register MR2.
XPIO5/EXPM/AASND/CMP1 YPIO5/EXPM/AASND/CMP1 ZPIO5/EXPM/AASND/CMP1 UPIO5/EXPM/AASND/CMP1	58 77 96 115	Bi-directional B – F –	Universal Input Output5 / External Operation- / Acceleration Ascend / Compare MR1: general purpose input / output signals (PIO5), External Operation- (EXPM), acceleration increasing status output signal (AASND), MR1 comparison output (CMP1) share the same pin. The signal to use can be set as commands. About general purpose input / output signals (PIO5), it is the same as PIO7. For synchronous action, it can be used as the input signal of an activation factor. External Operation- (EXPM) is – direction drive starting signal from external source. When the relative position driving is commanded from an external source, – direction relative position driving starts by down (↓) of this signal. When the continuous pulse driving is commanded from an external source, – direction continuous pulse driving is performed while this signal is on the Low level. In the manual pulsar mode, the encoder B-phase signal is input to this pin. Acceleration increasing status output (AASND) becomes Hi while the driving command is executed and when acceleration increase. MR1 comparison output (CMP1) becomes Hi when it satisfies the comparison condition of multi-purpose register MR1.

Signal Name	Pin No.	Input/Output	Signal Description
XPIO4/EXPP/DSND/CMP0 YPIO4/EXPP/DSND/CMP0 ZPIO4/EXPP/DSND/CMP0 UPIO4/EXPP/DSND/CMP0	59 78 97 116	Bi-directional B - F -	<p>Universal Input Output4 / External Operation+ / Descend / Compare MR0: general purpose input / output signals (PIO4), External Operation+ (EXPP), deceleration status output signal (DSND), MR0 comparison output (CMP0) share the same pin. The signal to use can be set as commands.</p> <p>About general purpose input / output signals (PIO4), it is the same as PIO7.</p> <p>For synchronous action, it can be used as the input signal of an activation factor.</p> <p>External Operation+ (EXPP) is + direction drive starting signal from external source. When the relative position driving is commanded from an external source, + direction relative position driving starts by down (↓) of this signal. When the continuous pulse driving is commanded from an external source, + direction continuous pulse driving is performed while this signal is on the Low level. In the manual pulsar mode, the encoder A-phase signal is input to this pin.</p> <p>Deceleration status output (DSND) becomes Hi while the driving command is executed and when in deceleration.</p> <p>MR0 comparison output (CMP0) becomes Hi when it satisfies the comparison condition of multi-purpose register MR0.</p>
XPIO3/CNST YPIO3/CNST ZPIO3/CNST UPIO3/CNST	60 79 98 117	Bi-directional B - F -	<p>Universal Input Output3 / Constant: general purpose input / output signals (PIO3), constant speed driving status output signal (CNST) share the same pin. The signal to use can be set as commands.</p> <p>About general purpose input / output signals (PIO3), it is the same as PIO7.</p> <p>For synchronous action, it can be used as the input signal of an activation factor or the output signal of synchronous pulses of the action. The logical level of synchronous pulses and pulse width can be set as commands.</p> <p>Constant speed driving status output (CNST) becomes Hi while the driving command is executed and when in constant speed driving.</p>
XPIO2/ASND YPIO2/ASND ZPIO2/ASND UPIO2/ASND	61 80 99 118	Bi-directional B - F -	<p>Universal Input Output2 / Ascend: general purpose input / output signals (PIO2), acceleration status output signal (ASND) share the same pin. The signal to use can be set as commands.</p> <p>About general purpose input / output signals (PIO2), it is the same as PIO7.</p> <p>About synchronous action, it is the same as PIO3.</p> <p>Acceleration status output (ASND) becomes Hi while the driving command is executed and when in acceleration.</p>
XPIO1/ERROR YPIO1/ERROR ZPIO1/ERROR UPIO1/ERROR	62 81 100 119	Bi-directional B - F -	<p>Universal Input Output1 / Error: general purpose input / output signals (PIO1), error status output signal (ERROR) share the same pin. The signal to use can be set as commands.</p> <p>About general purpose input / output signals (PIO1), it is the same as PIO7.</p> <p>About synchronous action, it is the same as PIO3.</p> <p>Error status output (ERROR) becomes Hi while an error occurs.</p>
XPIO0/DRIVE YPIO0/DRIVE ZPIO0/DRIVE UPIO0/DRIVE	63 82 101 120	Bi-directional B - F -	<p>Universal Input Output0 / Drive: general purpose input / output signals (PIO0), drive status output signal (DRIVE) share the same pin. The signal to use can be set as commands.</p> <p>About general purpose input / output signals (PIO1), it is the same as PIO7.</p> <p>About synchronous action, it is the same as PIO3.</p> <p>Drive status display output (DRIVE) is set at High level while drive pulses are output. At execution of automatic home search, this signal is set at High level. The DRIVE signal is set at High level until INPOS becomes active when INPOS signal for the serve motor is enabled by mode selection.</p>

Signal Name	Pin No.	Input/Output	Signal Description
XDCC YDCC ZDCC UDCC	64 83 102 121	Output A	Deviation Counter Clear: deviation counter clear output signal A deviation counter clear output (DCC) signal is output for a server motor driver. The signal can be output by mode setting in automatic home search. It can also be output by a command.
XSPLTP YSPLTP ZSPLTP USPLTP	65 84 103 122	Output A	Split Pulse: Outputs split pulses Split pulse output can be started and stopped by a synchronous action or a command. Split length, pulse width and pulse number can be set by a command. And output logic, with or without starting pulse can be set as commands.
PIN7/MPLS	132	Bi-directional C	Universal Input7/: general purpose input signal. Gets the input value by general purpose input value reading command (48h), Low level is 0 and Hi level is 1. When performing multichip axes interpolation, connect this signal among chips and pull up to VDD (+3.3V) with 3.3kΩ impedance.
PIN6/MERR	133	Bi-directional E	Universal Input6/: general purpose input signal. Reading is the same as PIN7. When performing multichip axes interpolation, connect this signal among chips and pull up to VDD (+3.3V) with 3.3kΩ impedance.
PIN5/MINP	134	Bi-directional E	Universal Input5/: general purpose input signal. Reading is the same as PIN7. When performing multichip axes interpolation, connect this signal among chips and pull up to VDD (+3.3V) with 3.3kΩ impedance.
PIN4/MCLK	135	Bi-directional C	Universal Input4/: general purpose input signal. Reading is the same as PIN7. When performing multichip axes interpolation, connect this signal among chips and pull up to VDD (+3.3V) with 3.3kΩ impedance.
PIN3/MDT3	136	Bi-directional C	Universal Input3/: general purpose input signal. Reading is the same as PIN7. When performing multichip axes interpolation, connect this signal among chips and pull up to VDD (+3.3V) with 3.3kΩ impedance.
PIN2/MDT2	137	Bi-directional C	Universal Input2/: general purpose input signal. Reading is the same as PIN7. When performing multichip axes interpolation, connect this signal among chips and pull up to VDD (+3.3V) with 3.3kΩ impedance.
PIN1/MDT1	138	Bi-directional C	Universal Input1/: general purpose input signal. Reading is the same as PIN7. When performing multichip axes interpolation, connect this signal among chips and pull up to VDD (+3.3V) with 3.3kΩ impedance.
PIN0/MDT0	139	Bi-directional C	Universal Input0/: general purpose input signal. Reading is the same as PIN7. When performing multichip axes interpolation, connect this signal among chips and pull up to VDD (+3.3V) with 3.3kΩ impedance.
EMGN	140	Input B — F —	Emergency Stop: input signal to perform the emergency stop for all axes When this signal is set at Low level during the driving, driving of all axes including interpolation driving stops immediately and EMG bit of RR2 register becomes 1. When the filter function is disabled, the low level pulse width must be more than 2CLK. [Note] For this signal, its logical level cannot be selected.
TEST1 TEST2	141,142	—	Test: input terminal for internal-circuit test Make sure that both pins are open or connected to GND. This is pulled down to GND with 50kΩ inside the IC.
GND	10,20,36, 55,72,90, 108,126,144		Ground (0V) Terminal All of the pins must be connected to 0V.

Signal Name	Pin No.	Input/Output	Signal Description
VDD	9,19,35, 53,71,89, 107,125,143		+3.3V Power Terminal All of the pins must be connected to each power without fail.

5.3 Input/Output Logic

Input A	<p>LVTTL Schmitt trigger input, which is high impedance because there is no pull high resistor for those signals in this IC.</p> <p>Input is 5V tolerant. 3.3V and 5V type output (CMOS level and TTL level) can be connected.</p> <p>The user should connect to GND or VDD if the input is not used.</p>
Input B	<p>LVTTL Schmitt trigger input, which is pulled up with 50kΩ in the IC.</p> <p>Input is 5V tolerant. 3.3V and 5V type output (CMOS level and TTL level) can be connected.</p> <p>The user should be Open or connect to VDD if the input is not used.</p> <p>The signal with – F – symbol has an integral filter circuit in the internal input column of this IC.</p>
Output A	<p>It is 3.3V type CMOS level output, 6mA driving buffer (Hi level output current IOH=–6mA, VOH=2.6Vmin, Low level output current IOL=6mA, VOL=0.4Vmax).</p> <p>When in Hi level output, do not apply voltage more than the output voltage from outside.</p> <p>5V type input can be connected when the other input is TTL level. If the other input is 5V type CMOS level, it cannot be connected. ※Note1</p>
Output B	<p>It is open collector type output, 12mA driving buffer, (Low level output current IOL=12mA, VOL=0.4Vmax).</p> <p>Pull up to +3.3V with high impedance if this output is used. It can also be connected to TTL level 5V type IC.</p>
Bi-directional A	<p>Input side is 5V tolerant LVTTL Schmitt trigger. Because there is no pull high resistor for those signals in this IC, the user should pull up the data bus with high impedance.</p> <p>The user should pull up to +3.3V with high impedance (about 10k~100kΩ) when bits D15~D8, PIN6, 5 are not used.</p> <p>It is better to be through high impedance rather than to pull-up/pull-down directly because this signal is bi-directional.</p> <p>When in Hi level output, do not apply voltage more than the output voltage from outside.</p> <p>Output side is 3.3V type CMOS level output, 12mA driving buffer (Hi level output current IOH=–12mA, VOH=2.6Vmin, Low level output current IOL=12mA, VOL=0.4Vmax).</p> <p>5V type bi-directional IC can be connected when the other input is TTL level. If the other input is 5V type CMOS level, it cannot be connected. ※Note1</p>
Bi-directional B	<p>Input side is 5V tolerant LVTTL Schmitt trigger, which is pulled up with 50kΩ (Typ.) in the IC.</p> <p>When in Hi level output, do not apply voltage more than the output voltage from outside.</p> <p>Output side is 3.3V type CMOS level output, 6mA driving buffer (Hi level output current IOH=–6mA, VOH=2.6Vmin, Low level output current IOL=6mA, VOL=0.4Vmax).</p> <p>5V type bi-directional IC can be connected when the other input is TTL level. If the other input is 5V type CMOS level, it cannot be connected. ※Note1</p> <p>The signal with – F – symbol has an integral filter circuit in the internal input column of this IC.</p>
Bi-directional C	<p>Input side is 5V tolerant LVTTL Schmitt trigger, which is pulled up with 100kΩ (Typ.) in the IC.</p> <p>Output side is activated during multichip axes interpolation. When signals are connected among chips in multichip axes interpolation, please shorten the length of wiring as far as possible and do not cross other signal paths.</p> <p>The user should be Open if the input is not used.</p>
Bi-directional D	<p>I²C exclusive SDA signal.</p> <p>Input side is 5V tolerant LVTTL Schmitt trigger. Because there is no pull high resistor for those signals in this IC, the user should pull up the data bus with high impedance.</p> <p>Output side is open collector type output of 6mA driving buffer. When used as SDA signal, pull up to VDD through a resistor.</p> <p>The user should pull up to VDD with high impedance or connect to GND directly if this is not used.</p>
Bi-directional E	<p>Input side is 5V tolerant LVTTL Schmitt trigger. Because there is no pull high resistor for those signals in this IC, the user should pull up the data bus with high impedance.</p> <p>Output side is open collector type output.</p> <p>When signals are connected among chips in multichip axes interpolation, please shorten the length of wiring as far as possible and do not cross other signal paths.</p> <p>The user should pull up to VDD with high impedance or connect to GND directly if this is not used.</p>

Note1: Even if the output signals of output A and Bi-directional A, B are pulled up to 5V through resistor, Hi level output voltage cannot raise to Hi level input voltage of 5V type CMOS. Please don't design the logic like this.

5.4 Remarks of Logic Design

a. About TEST1, 2 Pins

Make sure that TEST1, 2 (141, 142) pins are open or connected to GND. If set at Hi, it will not work correctly at all due to running the internal test circuit.

b. About Unused Input Pins

Make sure that unused input pin A is connected to GND or VDD. If the unused pin is open, the signal level of the pin will be unstable and may cause malfunction. Input pin B can be open.

c. About Unused Bi-directional Pins

Make sure that unused bi-directional pins (Bi-directional A, D, E) are connected to VDD or GND through high impedance (about 10k~ 100 k Ω). If these pins are directly connected to GND or VDD, the IC may be damaged by overcurrent in case of such as a programming mistake causes the output state. Bi-directional pins B, C can be open.

d. De-coupling Capacitor

Please connect VDD and GND with three or four De-coupling capacitors (about 0.1 μ F).

e. Ringing noise by Terminal Induction

Ringing noise may occurred by inductance and load capacity of the output pin. The user can add a capacitor (10-100pF) to pins to reduce the noise.

f. Reflection on Transfer Path

The load capacity for outputting types A, B, and bi-directional A~E is 20-50pF. So, the reflection will happen if the PCB wiring is more than 60cm. Please shorten the PCB wiring length as shorter as you can.

g. Example of Connection between MCX514 and 5V type IC

The input/output of MCX514 is 5V tolerant. But its output can connect with TTL level input only. It cannot connect with CMOS level input.

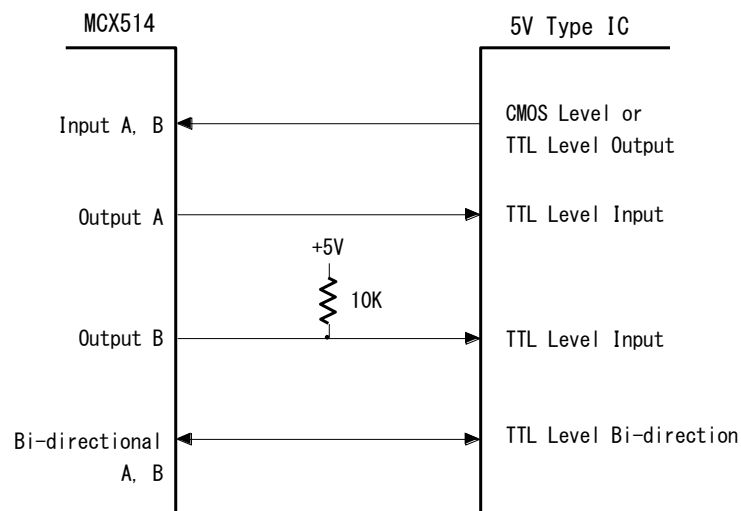

6. Register

This chapter describes the user how to access all the registers in MCX514, and what are the mapping addresses of these registers.

6.1 Register Address by 16-bit Data Bus

As shown in the table below, when 16-bit data bus is used, the access address of read / write register is 8-bit.

■ Write Register in 16-bit Data Bus

All registers are 16-bit length.

Address A2 A1 A0	Symbol	Register Name	Contents
0 0 0	WR0	Command Register	• for axis assignment and setting command
0 0 1	XWR1 YWR1 ZWR1 UWR1	X-axis Mode register 1 Y-axis Mode register 1 Z-axis Mode register 1 U-axis Mode register 1	• for setting the valid / invalid of interrupt
0 1 0	XWR2 YWR2 ZWR2 UWR2	X-axis Mode register 2 Y-axis Mode register 2 Z-axis Mode register 2 U-axis Mode register 2	• for setting the logical levels and enable/disable of external decelerating stop • for setting the logical levels and enable/disable of servo motor signal • for setting the limit signal mode and software limit mode
0 1 1	XWR3 YWR3 ZWR3 UWR3	X-axis Mode register 3 Y-axis Mode register 3 Z-axis Mode register 3 U-axis Mode register 3	• for setting the auto and manual deceleration • for setting the acceleration/deceleration mode (symmetry/ non-symmetry, linear acceleration/deceleration, S-curve acceleration/deceleration) • for setting the drive pulse output mode and pins • for setting the encoder input signal mode and pins
1 0 0	WR4	Output register 1	• for setting the output values of X-axis general purpose input/output signals XPIO7~0 • for setting the output values of Y-axis general purpose input/output signals YPIO7~0
1 0 1	WR5	Output register 2	• for setting the output values of Z-axis general purpose input/output signals ZPIO7~0 • for setting the output values of U-axis general purpose input/output signals UPIO7~0
1 1 0	WR6	Data writing register 1	• for setting the low word 16-bit (D15~D0) for data writing
1 1 1	WR7	Data writing register 2	• for setting the high word 16-bit (D31~D16) for data writing

- As shown in the table above, each axis has WR1, WR2 and WR3 mode registers, which will be written by the same address. The host CPU specifies which axis should be accessed depends on the axis of written command just before. Or the user can specify the axis by writing NOP command with axis assignment.
- The bits of WR1, WR2, WR3, WR4 and WR5 are cleared to 0 at reset.

■ Read Register in 16-bit Data Bus

All registers are 16-bit length.

Address A2 A1 A0	Symbol	Register Name	Contents
0 0 0	RR0	Main status register	<ul style="list-style-type: none"> • driving status and error status • ready for interpolation, quadrant for circle interpolation and continuous interpolation pre-buffer stack counter (SC)
0 0 1	XRR1 YRR1 ZRR1 URR1	X-axis Status register 1 Y-axis Status register 1 Z-axis Status register 1 U-axis Status register 1	<ul style="list-style-type: none"> • interrupt message
0 1 0	XRR2 YRR2 ZRR2 URR2	X-axis Status register 2 Y-axis Status register 2 Z-axis Status register 2 U-axis Status register 2	<ul style="list-style-type: none"> • error message • finishing status
0 1 1	XRR3 YRR3 ZRR3 URR3	X-axis Status register 3 Y-axis Status register 3 Z-axis Status register 3 U-axis Status register 3	<ul style="list-style-type: none"> ● Page 0 <ul style="list-style-type: none"> • input signal status • automatic home search execution state ● Page 1 <ul style="list-style-type: none"> • enable/disable of synchronous action set • acceleration/deceleration status, increase/decrease status of acceleration/deceleration • status of timer and split pulse operation • finish point data transfer error during multichip interpolation
1 0 0	RR4	PIO read register 1	<ul style="list-style-type: none"> • X-axis general purpose input/output signal status • Y-axis general purpose input/output signal status
1 0 1	RR5	PIO read register 2	<ul style="list-style-type: none"> • Z-axis general purpose input/output signal status • U-axis general purpose input/output signal status
1 1 0	RR6	Data reading register 1	<ul style="list-style-type: none"> • low word of data register (D15~D0)
1 1 1	RR7	Data reading register 2	<ul style="list-style-type: none"> • high word of data register (D31~D16)

- As with Write Register, each axis has RR1, RR2 and RR3 status registers, which will be read by the same address. The host CPU specifies which axis should be accessed depends on the axis of written command just before. Or the user can specify the axis by writing NOP command with axis assignment.
- Regarding RR3 register, there are 2 kinds: Page 0 and Page1. The page can be specified by writing RR3 page display command (7Ah, 7Bh). It will be Page 0 at reset.

6.2 Register Address by 8-bit Data Bus

For the 8-bit data bus access, the 16-bit data bus can be divided into high and low word byte. As shown in the table below, xxxxL is the low word byte (D7~D0) of 16-bit register xxxx, xxxxH is the high word byte (D15~8) of 16-bit register xxxx. To the command register (WR0L, WR0H), make sure to first write the high word byte (WR0H), and next write the low word byte (WR0L).

■ Write Register in 8-bit Data Bus

Address A3 A2 A1 A0	Write Register
0 0 0 0	WR0L
0 0 0 1	WR0H
0 0 1 0	WR1L
0 0 1 1	WR1H
0 1 0 0	WR2L
0 1 0 1	WR2H
0 1 1 0	WR3L
0 1 1 1	WR3H
1 0 0 0	WR4L
1 0 0 1	WR4H
1 0 1 0	WR5L
1 0 1 1	WR5H
1 1 0 0	WR6L
1 1 0 1	WR6H
1 1 1 0	WR7L
1 1 1 1	WR7H

■ Read Register in 8-bit Data Bus

Address A3 A2 A1 A0	Read Register
0 0 0 0	RR0L
0 0 0 1	RR0H
0 0 1 0	RR1L
0 0 1 1	RR1H
0 1 0 0	RR2L
0 1 0 1	RR2H
0 1 1 0	RR3L
0 1 1 1	RR3H
1 0 0 0	RR4L
1 0 0 1	RR4H
1 0 1 0	RR5L
1 0 1 1	RR5H
1 1 0 0	RR6L
1 1 0 1	RR6H
1 1 1 0	RR7L
1 1 1 1	RR7H

6.3 Register Address by I²C Serial Interface Bus Mode

When MCX514 is used in I²C serial interface bus, the user can access a register address by slave address control.

Follow the same way to specify a register address as described in chapter 6.2, dividing the 16 bit data bus into high and low word byte.

For more details of I²C serial interface bus, see chapter 4.

6.4 Command Register: WR0

Command register is used for axis assignment and command registration for each axis in MCX514. The register is composed of the bit for axis assignment and setting command code.

After command code has been written to this register, the command will be executed immediately. The data writing command such as a drive speed setting must be written to registers WR6 and WR7 first. Otherwise, when the reading command is engaged, the data will be written and set, through IC internal circuit, to registers RR6 and RR7.

When using the 8-bit data bus, the user must write the high word byte (H) first, and the low word byte (L) next. A command will be executed to the axis to be prior assigned immediately after writing the low word byte.

It requires 125nsec (maximum) to access the command code when CLK=16MHz. Please don't write the next command during the period of time.

WR0	D15	D14	D13	D12 ^H	D11	D10	D9	D8	D7	D6	D5	D4 ^L	D3	D2	D1	D0
	0	0	0	0	U	Z	Y	X								
	Axis Assignment								Command Code							

D7~0 Command code setting.

D11~8 Axis assignment.
When the bits of the axis are set as 1, the axis is assigned. The assignment is not limited only for one axis, but for multi-axes simultaneously. It is possible to write the same parameters also. However, for data reading, assign only one axis.

Other bits must be set as 0; otherwise, the unknown situation could happen due to IC internal circuit test.

6.5 Mode Register1: WR1

Each axis has mode register WR1 individually. The host CPU specifies the mode register of which axis should be accessed depends on the axis of written command just before. Or the user can specify the axis by writing NOP command with axis assignment.

Mode register WR1 is used for setting each interrupt factor to enable/disable. Each bit is set: 1: enable, 0: disable

WR1	D15	D14	D13	D12 ^H	D11	D10	D9	D8	D7	D6	D5	D4 ^L	D3	D2	D1	D0
	SYNC3	SYNC2	SYNC1	SYNC0	SPLTE	SPLTP	TIMER	H-END	D-END	C-END	C-STA	D-STA	CMR3	CMR2	CMR1	CMR0
	Interrupt Enable/Disable															

D3~0 CMR3~0 Interrupt occurs when the comparison result of multi-purpose register MR3~0 with a comparative object changes to meet the comparison condition. Use multi-purpose register mode setting command (20h) to set the object which the user wants to compare with MR3~0 and comparison condition.

D4 D-STA Interrupt occurs at the start of driving.

D5 C-STA Interrupt occurs when pulse output starts at constant speed area in acceleration / deceleration driving.

D6 C-END Interrupt occurs when pulse output is finished at constant speed area in acceleration / deceleration driving.

D7 D-END Interrupt occurs when the driving is finished.

D8 H-END Interrupt occurs when the automatic home search is finished.

D9 TIMER Interrupt occurs when the timer expires.

- D10 SPLTP Interrupt occurs at the \uparrow of a pulse in each split pulse. (When the split pulse logic is set with Hi pulse)
- D11 SPLTE Interrupt occurs when the split pulse is finished.
- D15~12 SYNC3~0 Interrupt occurs when synchronous action SYNC3~0 is activated.
- D15~D0 will be set as 0 at reset.

6.6 Mode Register2: WR2

Each axis has mode register WR2 individually. The host CPU specifies the mode register of which axis should be accessed depends on the axis of written command just before. Or the user can specify the axis by writing NOP command with axis assignment.

Mode register WR2 is used for setting: (1). input signal nSTOP2~ nSTOP0 (decelerating stop / instant stop during the driving), (2). input signal for a servo motor, (3). external limit inputs, (4). software limit.

WR2	H								L							
	D15	D14	D13	D12	D11	D10	D9	D8	D7	D6	D5	D4	D3	D2	D1	D0
	SLM-M	SLM-O	SLM-E	HLM-M	HLM-E	HLM-L	ALM-E	ALM-L	INP-E	INP-L	SP2-E	SP2-L	SP1-E	SP1-L	SPO-E	SPO-L

- D4, 2, 0 SPk-L The bit for setting enable logical levels for driving stop input signal nSTOPk (k:2~0).
0: active on the Low level, 1: active on the Hi level
In automatic home search, the logical level of the nSTOPk signal that is used is set to these bits.
- D5, 3, 1 SPk-E The bit for setting enable / disable of driving stop input signal nSTOPk (k:2~0).
0: disable, 1: enable
Once nSTOP2~ nSTOP0 are active and then driving starts, when nSTOPk signal becomes active level, the decelerating stop will be performed during acceleration / deceleration driving and the instant stop will be performed during constant speed driving.
In automatic home search, the enable / disable bits of nSTOPk that are used should be set as disable.
- D6 INP-L Setting logical level of in-position input signal nINPOS from a servo driver.
0: active on the Low level, 1: active on the Hi level
- D7 INP-E Setting enable / disable of nINPOS input signal.
0: disable, 1: enable
When it is enabled, the DRIVE bit of RR0 (main status) register does not return to 0 until nINPOS signal is on its active level after the driving is finished.
- D8 ALM-L Setting active level of servo alarm input signal nALARM.
0: active on the Low level, 1: active on the Hi level
- D9 ALM-E Setting enable / disable of input signal nALARM.
0: disable, 1: enable
When it is enabled, it checks input signal nALARM during the driving. And if it is active, D4 (ALARM) bit of RR2 register will become 1 and the driving will stop.
- D10 HLM-L Setting logical level of hardware limit input signals nLMTP, nLMTM.
0: active on the Low level, 1: active on the Hi level
- D11 HLM-E Setting enable / disable of nLMTP, nLMTM limit input signals.
0: disable, 1: enable
Once it is enabled, if nLMTP limit input signal is active during the + direction driving, D2 (HLMT+) bit of RR2 register will become 1 and if nLMTM limit input signal is active during the - direction driving, D3 (HLMT-) bit of RR2 register will become 1. When it becomes active level, driving stops.
- D12 HLM-M The bit for controlling stop type when nLMTP, nLMTM limit input signals are active.

0: instant stop, 1: decelerating stop

When limit signal is used as the stop signal of an automatic home search, set as 1: decelerating stop.

- D13 SLM-E Setting enable / disable of software limit function.
0: disable, 1: enable
Once it is enabled, if + direction software limit error occurs during the + direction driving, D0 (SLMT+) bit of RR2 register will become 1 and if - direction software limit error occurs during the - direction driving, D1 (SLMT-) bit of RR2 register will become 1.
• If + direction software limit: comparative position counter \geq SLMT+ value, then error and driving stops.
• If - direction software limit: comparative position counter $<$ SLMT- value, then error and driving stops.
Driving commands for the direction in which software limit error occurs will not be executed.
- D14 SLM-0 Setting the object of software limit to real position counter or logical position counter.
0: logical position counter, 1: real position counter
- D15 SLM-M The bit for controlling stop type when software limit function is enabled.
0: decelerating stop, 1: instant stop
(Note that the bit 0/1 is opposite of the bit for controlling stop type of hardware limit signals.)

D15~D0 will be set as 0 at reset.

6.7 Mode Register3: WR3

Each axis has mode register WR3 individually. The host CPU specifies the mode register of which axis should be accessed depends on the axis of written command just before. Or the user can specify the axis by writing NOP command with axis assignment.

Mode register WR3 is used for setting: (1). manual deceleration, (2). acceleration/deceleration mode (symmetry / non-symmetry, linear acceleration/deceleration, S-curve acceleration/deceleration), (3). drive pulse output mode, (4). encoder input mode, (5). limit signal pin inversion, (6). trapezoid triangle form prevention function, (7). repeat timer.

WR3	H								L							
	D15	D14	D13	D12	D11	D10	D9	D8	D7	D6	D5	D4	D3	D2	D1	D0
	0	TMMD	AVTRI	LMINV	PIINV	PI-L	PIMD1	PIMD0	DPINV	DIR-L	DP-L	DPMD1	DPMD0	SACC	DSNDE	MANLD

- D0 MANLD Setting manual / automatic deceleration for fixed pulse acceleration / deceleration driving.
0: automatic deceleration, 1: manual deceleration
The decelerating point (DP) should be set if the manual deceleration mode is engaged.
- D1 DSNDE Setting decelerating rate whether to use the rate of the acceleration (symmetry) or an individual decelerating rate (non-symmetry).
Set whether jerk (symmetry) or an individual deceleration increasing rate (non-symmetry) is used as a deceleration increasing rate at S-curve deceleration.
0: symmetry acceleration/deceleration, 1: non-symmetry acceleration/deceleration
Automatic deceleration cannot be performed for non-symmetrical S-curve acceleration / deceleration fixed pulse driving. In this case, the D0 (MANLD) bit must be set as 1 and a manual deceleration point (DP) must be set.
- D2 SACC Setting the speed curve to either linear driving or S-curve driving during acceleration/deceleration driving.
0: linear driving, 1: S-curve driving
Before S-curve driving is engaged, jerk (JK) and deceleration increasing rate (DJ) must be set.

- D4, 3 DPMD1, 0 Setting pulse output type.

D4(DPMD1)	D3(DPMD0)	Pulse Output Type
0	0	Independent 2-pulse
0	1	1-pulse 1-direction
1	0	Quadrature pulse and quad edge evaluation
1	1	Quadrature pulse and double edge evaluation

When independent 2-pulse type is engaged, + direction pulses are output through the output signal nPP, and – direction pulses through nPM.

When 1-pulse 1-direction type is engaged, + and – directions pulses are output through the output signal nPLS, and nDIR is for direction signals.

When quadrature pulse type is engaged, the A-phase signal of quadrature pulse is output through the output signal nPA, and the B-phase signal of quadrature pulse through nPB.

- D5 DP-L Setting logical level of driving pulses.
0: positive logical level, 1: negative logical level



- D6 DIR-L Setting logical level of the direction (nDIR) output signal for 1-pulse 1-direction mode DIR-L.

D6(DIR-L)	+ direction	– direction
0	Low	Hi
1	Hi	Low

- D7 DPINV Replaces output pins of drive pulse output between nPP/PLS/PA signal and nPM/DIR/PB signal.
0: initial setting, 1: pin inversion

When this bit is set as 1 and pulse output type is independent 2-pulse, drive pulses are output to the nPM signal during the + direction driving and to the nPP signal during the – direction driving. In the same way, output pins are replaced when in other pulse output types.

- D9, 8 PIMD1, 0 Setting encoder pulse input type.
Real position counter counts Up/Down according to an encoder input signal.

D9(PIMD1)	D8(PIMD0)	Encoder pulse input type
0	0	Quadrature pulses input and quad edge evaluation
0	1	Quadrature pulses input and double edge evaluation
1	0	Quadrature pulses input and single edge evaluation
1	1	Up / Down pulse input

When quadrature pulses input type is engaged and nECA signal goes faster 90 degree phase than nECB signal does, it's "count up" and nECB signal goes faster 90 degree phase than nECA signal does, it's "count down". And when quad edge evaluation is set, it counts Up/Down at the rising edge (↑) and falling edge (↓) of both signals. When double edge evaluation is set, it counts Up/Down at the rising edge (↑) and falling edge (↓) of A-phase signals. When single edge evaluation is set, it counts Up at the rising edge (↑) of A-phase signals in the Low of B-phase signal, and it counts Down at the falling edge (↓) of A-phase signals in the Low of B-phase signal.

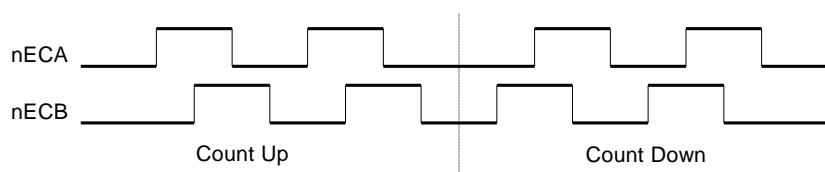

When Up / Down pulse input type is engaged, nPPIN signal is for "count up" input, and nPMIN signal is for "count down" input. So, it will count up when the positive pulses go up (↑).

- D10 PI-L** Setting logical level of an encoder input signal.
0: positive logical level, 1: negative logical level
When Up / Down pulse input type is engaged, it will count at the falling edge (↓) of the negative pulses.
- D11 PIINV** Replaces input pins of encoder pulse input between nECA /PPIN signal and nECB /PMIN signal.
0: initial setting, 1: pin inversion
This reverses the increase/decrease of the real position counter.

D11(PIINV)	Encoder pulse input type	Increase/decrease of real position counter (RP)
0	quadrature pulses input	Count UP when the A phase is advancing. Count DOWN when the B phase is advancing.
	Up / Down pulse input	Count UP at nPPIN pulse input. Count DOWN at nPMIN pulse input.
1	quadrature pulses input	Count UP when the B phase is advancing. Count DOWN when the A phase is advancing.
	Up / Down pulse input	Count UP at nPMIN pulse input. Count DOWN at nPPIN pulse input.

- D12 LMINV** Replaces input pins of hardware limit input signals between nLMTP and nLMTM.
0: initial setting, 1: pin inversion
When this bit is set as 1, nLMTP signal is used as a limit signal for the – direction and nLMTM signal is used as a limit signal for the + direction.
- D13 AVTRI** Setting enable / disable of triangle form prevention function in linear acceleration fixed pulse driving.
The triangle form prevention function is enabled at reset.
0: enable, 1: disable
- D14 TMMD** Setting once / repeat timer.
0: once, 1: repeat

D15~D0 will be set as 0 at reset. D15 should always be set as 0.

6.8 Output Register: WR4

This register is used for setting the X-axis general purpose input / output signals XPIO7~0 and Y-axis general purpose input / output signals YPIO7~0 as general purpose output. It is Low level output when the bit is set as 0, and Hi level output when the bit is set as 1.

WR4	D15	D14	D13	D12 ^H	D11	D10	D9	D8	D7	D6	D5	D4 ^L	D3	D2	D1	D0
	YPI07	YPI06	YPI05	YPI04	YPI03	YPI02	YPI01	YPI00	XPI07	XPI06	XPI05	XPI04	XPI03	XPI02	XPI01	XPI00

D15~D0 will be set as 0 at reset.

6.9 Output Register: WR5

This register is used for setting the Z-axis general purpose input / output signals ZPIO7~0 and U-axis general purpose input / output signals UPIO7~0 as general purpose output. It is Low level output when the bit is set as 0, and Hi level output when the bit is set as 1.

WR5	D15	D14	D13	D12 ^H	D11	D10	D9	D8	D7	D6	D5	D4 ^L	D3	D2	D1	D0
	UPI07	UPI06	UPI05	UPI04	UPI03	UPI02	UPI01	UPI00	ZPI07	ZPI06	ZPI05	ZPI04	ZPI03	ZPI02	ZPI01	ZPI00

D15~D0 will be set as 0 at reset.

6.10 Data Register: WR6/WR7

Data registers are used for setting the data of commands for writing data. The low-word data-writing 16-bit (WD15~WD0) is for register WR6 setting, and the high-word data-writing 16-bit (WD31~WD16) is for register WR7 setting.

WR6	D15	D14	D13	D12 ^H	D11	D10	D9	D8	D7	D6	D5	D4 ^L	D3	D2	D1	D0
	WD15	WD14	WD13	WD12	WD11	WD10	WD9	WD8	WD7	WD6	WD5	WD4	WD3	WD2	WD1	WD0

WR7	D15	D14	D13	D12 ^H	D11	D10	D9	D8	D7	D6	D5	D4 ^L	D3	D2	D1	D0
	WD31	WD30	WD29	WD28	WD27	WD26	WD25	WD24	WD23	WD22	WD21	WD20	WD19	WD18	WD17	WD16

The user can write command data with a designated data length into the write register. It does not matter to write WR6 or WR7 first (when 8-bit data bus is used, the registers are WR6L, WR6H, WR7L and WR7H).

The written data is binary and 2's complement is used for negative numbers.

For command data, the user should use designated data length.

The data of WR6 and WR7 registers are unknown at reset.

6.11 Main Status Register: RR0

Main status register is used for displaying the driving and error status of each axis. It also displays ready signal for continuous interpolation, quadrant of circular interpolation and continuous interpolation pre-buffer stack counter (SC).

RR0	D15	D14	D13	D12 ^H	D11	D10	D9	D8	D7	D6	D5	D4 ^L	D3	D2	D1	D0
	HSTC3	HSTC2	HSTC1	HSTC0	CNEXT	ZONE2	ZONE1	ZONE0	U-ERR	Z-ERR	Y-ERR	X-ERR	U-DRV	Z-DRV	Y-DRV	X-DRV

D3~0 n-DRV Displaying driving status of each axis. When the bit is 1, the axis is outputting drive pulses, and when the bit is 0, the driving of the axis is finished. During execution of automatic home search or helical calculation, this bit is set as 1.

Once the in-position input signal nINPOS for servomotor is active, nINPOS will return to 0 after the drive pulse output is finished.

D7~4 n-ERR Displaying error status of each axis. If any of the error bits (D7~D0) of each axis RR2 register becomes 1, this bit will become 1. When an error occurs in any axis of sub chip during multichip interpolation, the error bit of main axis in main chip will become 1.

During driving except interpolation driving (including automatic home search), this bit will return to 0 by the error/finishing status clear command (79h) or the start of next driving. When interpolation driving is performed, be sure to clear the error by the error/finishing status clear command (79h) after checking that interpolation drive stops. Otherwise, interpolation driving will not work properly after that.

D10~8 ZONEm Displaying the quadrant of the current position in circular interpolation.

D10	D9	D8	Quadrant
0	0	0	0
0	0	1	1
0	1	0	2
0	1	1	3
1	0	0	4
1	0	1	5
1	1	0	6
1	1	1	7

D11 CNEXT Displaying the writable state of next data for continuous interpolation. When interpolation driving is started, the bit is set as 1 during the period from 1 to 7 of pre-buffer stack counter, and it is possible to write interpolation data for next node (parameters and interpolation commands).

D15~12 HSTC3~0 Displaying the value of continuous interpolation pre-buffer stack counter (SC).

D15	D14	D13	D12	Stack Counter (SC)
0	0	0	0	0
0	0	0	1	1
0	0	1	0	2
0	0	1	1	3
0	1	0	0	4
0	1	0	1	5
0	1	1	0	6
0	1	1	1	7
1	0	0	0	8

During continuous interpolation driving, when SC is 8, it indicates the pre-buffer stack is the upper limit. And when SC is 7 and under, it is possible to write interpolation data for next node (parameters and interpolation commands). When SC is 0, it indicates all the interpolation data was output and continuous interpolation driving is finished.

6.12 Status Register 1: RR1

Each axis has status register RR1 individually. The host CPU specifies the status register of which axis should be accessed depends on the axis of written command just before. Or the user can specify the axis by writing NOP command with axis assignment.

Status register RR1 is used for displaying an interrupt factor. When an interrupt occurs, the bit with the interrupt factor becomes 1. To generate an interrupt, interrupt Enable must be set for each factor in WR1 register.

RR1	D15	D14	D13	D12 ^H	D11	D10	D9	D8	D7	D6	D5	D4 ^L	D3	D2	D1	D0
	SYNC3	SYNC2	SYNC1	SYNC0	SPLTE	SPLTP	TIMER	H-END	D-END	C-END	C-STA	D-STA	CMR3	CMR2	CMR1	CMR0
Interrupt Factor																

- D3~0 CMR3~0 Indicates that an interrupt occurred when the comparison result of multi-purpose register MR3~0 with a comparative object changed to meet the comparison condition.
Use multi-purpose register mode setting command (20h) to set the object which the user wants to compare with MR3~0 and comparison condition.
- D4 D-STA Indicates that an interrupt occurred at the start of driving.
- D5 C-STA Indicates that an interrupt occurred when pulse output starts at constant speed area in acceleration / deceleration driving
- D6 C-END Indicates that an interrupt occurred when pulse output was finished at constant speed area in acceleration / deceleration driving.
- D7 D-END Indicates that an interrupt occurred when the driving was finished.
- D8 H-END Indicates that an interrupt occurred when the automatic home search was finished.
- D9 TIMER Indicates that an interrupt occurred when the timer expires.
- D10 SPLTP Indicates that an interrupt occurred at the \uparrow of a pulse in each split pulse.
(When the split pulse logic is set at Hi pulse)
- D11 SPLTE Indicates that an interrupt occurred when the split pulse was finished.
- D15~12 SYNC3~0 Indicates that an interrupt occurred when synchronous action SYNC3~0 was activated.

When one of the interrupt factors generates an interrupt, the bit of the register becomes 1, and the interrupt output signal (INT0N) will become the Low level. If the host CPU reads RR1 register, the bit of RR1 will be cleared to 0 and the interrupt signal (INT0N) will return to the non-active level.

[Note]

- In 8-bit data bus, RR1L will be cleared by reading of RR1L register and RR1H will be cleared by reading of RR1H register. RR1H will never be cleared by RR1L register and RR1L will never be cleared by RR1H register.
- When in I2C serial interface bus, do not read RR1L and RR1H registers separately and be sure to read 2 bytes (RR1L, RR1H) at one time.

6.13 Status Register 2: RR2

Each axis has status register RR2 individually. The host CPU specifies the status register of which axis should be accessed depends on the axis of written command just before. Or the user can specify the axis by writing NOP command with axis assignment.

Status register RR2 is used for displaying the error information and the status of driving finishing. When an error occurs during the driving, the error information bit (one of D7 to D0) is set as 1. When one or more of D7 to D0 bits of RR2 register are 1, n-ERR bit of the axis in main status register RR0 becomes 1.

When one or more bits of RR2 register are 1, the bits keep 1 even though the factor of the error or driving finishing is cleared. As for the error during driving except interpolation driving (including automatic home search), all bits will return to 0 by error/finishing status clear command (79h) or the start of next driving. And the error during interpolation driving, be sure to clear the error bit to 0 by error/finishing status clear command (79h) after checking that interpolation drive stops.

RR2	D15	D14	D13	D12 ^H	D11	D10	D9	D8	D7	D6	D5	D4 ^L	D3	D2	D1	D0
	EMG	ALARM	LMTM	LMTP	STOP2	STOP1	STOP0	SYNC	CERR	HOME	EMG	ALARM	HLMT-	HLMT+	SLMT-	SLMT+
	Status of Driving Finishing								Error Information							

D0	SLMT+	During the + direction driving with software limit function enabled, when comparative position counter \geq SLMT+ value, it becomes 1 and driving stops.
D1	SLMT-	During the - direction driving with software limit function enabled, when comparative position counter $<$ SLMT- value, it becomes 1 and driving stops.
D2	HLMT+	During the + direction driving with hardware limit signal enabled, when limit signal (nLMTP) is on its active level, it becomes 1 and driving stops.
D3	HLMT-	During the - direction driving with hardware limit signal enabled, when limit signal (nLMTM) is on its active level, it becomes 1 and driving stops.
D4	ALARM	During the driving with input signal for servo driver alarm enabled, when the alarm signal (nALARM) is on its active level, it becomes 1 and driving stops.
D5	EMG	During the driving, when emergency stop signal (EMGN) becomes Low level, it becomes 1 and driving stops.
D6	HOME	Error occurred at execution of an automatic home search. When the encoder Z-phase signal (nSTOP2) is already active at the start of Step 3, this bit is set as 1.
D7	CERR	Error related to continuous interpolation. It becomes 1 when writing of interpolation data for next node cannot be finished during continuous interpolation driving and then driving stops, or finish point data transfer error occurs in multichip interpolation. When finish point data transfer error occurs in multichip interpolation, D12 bit of RR3 register Page1 also becomes 1.

[Note]

- When hardware / software limit becomes active during driving, the decelerating stop or instant stop is executed. Unless the stop factor of driving is cleared, a driving command is not executed and an error occurs again even if a driving command in the same direction is written.
- The error information bits do not become 1 even if each factor is active during the stop of driving. About software / hardware limit, an error does not occur even if each factor becomes active in the reverse direction driving.
- When D7 bit becomes 1, be sure to write the error/finishing status clear command (79h) after checking that interpolation drive stops. Otherwise, interpolation driving will not work properly after that.

D8	SYNC	If the driving is stopped by one of synchronous actions (SYNC3 ~ 0), it will become 1.
----	------	--

D11~9	STOP2~0	If the driving is stopped by one of external stop signals (nSTOP2~0), it will become 1.
D12	LMT+	If the driving is stopped by +direction limit signal (nLMTP), it will become 1.
D13	LMT-	If the driving is stopped by -direction limit signal (nLMTM), it will become 1.
D14	ALARM	If the driving is stopped by nALARM from a servo driver, it will become 1.
D15	EMG	If the driving is stopped by external emergency signal (EMGN), it will become 1.

Driving finishing status (D15~D8) is the bit indicates the finishing factor of driving. There are 3 factors that terminate driving as shown below other than the factors that the status of driving finishing (D15~D8) indicate.

- when all the drive pulses are output in fixed pulse driving,
- when deceleration stop or instant stop command is written,
- when software limit is enabled, and is active,

Make sure to check the status of driving finishing (D15~D8) after confirming the driving is finished by the n-DRV bit of RR0 main status register.

6.14 Status Register 3: RR3

Each axis has status register RR3 individually. The host CPU specifies the status register of which axis should be accessed depends on the axis of written command just before. Or the user can specify the axis by writing NOP command with axis assignment.

Status register RR3 has 2 kinds of pages, Page 0 and Page1. Page 0 is used for displaying the input signal status and automatic home search execution state. Page 1 is used for displaying: (1). enable/disable of a synchronous action, (2). acceleration/deceleration status in acceleration/deceleration driving, (3). acceleration increasing/decreasing status in S-curve acceleration/deceleration, (4). timer operating state, (5). split pulse operating state, (6). transfer error status during multichip interpolation.

The page can be designated by writing RR3 Page Display Command (7Ah, 7Bh). It will be Page 0 at reset.

RR3 Page0	D15	D14	D13	D12 ^H	D11	D10	D9	D8	D7	D6	D5	D4 ^L	D3	D2	D1	D0
	0	HSST5	HSST4	HSST3	HSST2	HSST1	HSST0	LMTM	LMT+	ALARM	INPOS	ECB	ECA	STOP2	STOP1	STOP0
RR3 Page1	D15	D14	D13	D12 ^H	D11	D10	D9	D8	D7	D6	D5	D4 ^L	D3	D2	D1	D0
	1	0	0	MCERR	SPLIT	TIMER	ADSND	ACNST	AASND	DSND	CNST	ASND	SYNC3	SYNC2	SYNC1	SYNC0

■ Page 0

The input signal status bit of each signal is 0 if the input is on the Low level and 1 if the input is on the Hi level. When the functions of D8~D0 input signals are not used, they can be used as general purpose input signals.

In the description below, the number in brackets after signal name indicates the pin number from X axis to U axis in order.

D2~0	STOP2~0	Displaying the input status of external stop signals nSTOP2(70,91,110,129), nSTOP1(73,92,111,130), nSTOP0(74,93,112,131).
D3	ECA	Displaying the input status of encoder input pulse signal nECA/PPIN (45,47,49,51). The pin number for this bit does not change even though the pin inversion of encoder pulse input (WR3/D11 : PIINV) is set.
D4	ECB	Displaying the input status of encoder input pulse signal nECB/PMIN (46,48,50,52). The pin number for this bit does not change even though the pin inversion of encoder pulse input (WR3/D11 : PIINV) is set.
D5	INPOS	Displaying the input status of in-position input signal for a servomotor nINPOS (66,85,104,123).
D6	ALARM	Displaying the input status of servo alarm input signal nALARM (67,86,105,124).

D7	LMTD	Displaying the input status of hardware limit input signal nLMTD (68,87,106,127). The pin number for this bit does not change even though the pin inversion of hardware limit input (WR3/D12 : LMINV) is set.
D8	LMTM	Displaying the input status of hardware limit input signal nLMTM (69,88,109,128). The pin number for this bit does not change even though the pin inversion of hardware limit input (WR3/D12 : LMINV) is set.
D14~9	HSST5~0	The home search execution state indicates the operation currently executed while the automatic home search is performed. See chapter 2.5.5.
D15	PAGE	Indicates RR3 is displaying Page 0 and becomes 0.

■ Page 1

D3~0	SYNC3~0	It becomes 1 when SYNC3~0 is active. To enable a synchronous action, write a synchronous action enable command (8F~81h). To disable a synchronous action, written a synchronous action disable command (9F~91h).
------	---------	---

D4	ASND	It becomes 1 at acceleration areas in acceleration/deceleration driving.
D5	CNST	It becomes 1 at constant speed area in acceleration/deceleration driving.
D6	DSND	It becomes 1 at deceleration areas in acceleration/deceleration driving.
D7	AASND	In S-curve, it becomes 1 when acceleration / deceleration increases..

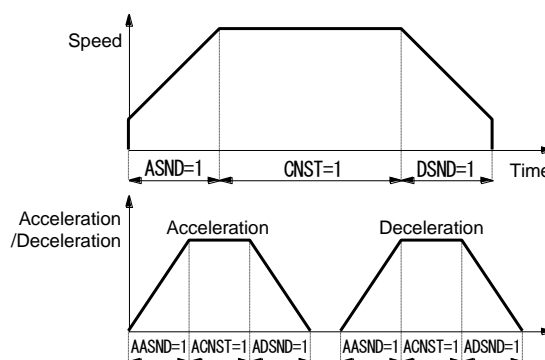

D8	ACNST	In S-curve, it becomes 1 when acceleration / deceleration keeps constant.
D9	ADSND	In S-curve, it becomes 1 when acceleration / deceleration decreases.
D10	TIMER	It becomes 1 when the timer is in operation.
D11	SPLIT	It becomes 1 when the split pulse is in operation.
D12	MCERR	It becomes 1 when the finish point data transfer error occurs during multichip interpolation. In this case, D7 bit of RR2 register also becomes 1.
D15	PAGE	Indicates RR3 is displaying Page 1 and becomes 1.

6.15 PIO Read Register 1: RR4

PIO read register RR4 is used for displaying the signal status of general purpose input / output signals XPIO7~0 in X axis and general purpose input / output signals YPIO7~0 in Y axis. The bit is 0 if the signal is on the Low level; the bit is 1 if the signal is on the Hi level.

RR4	D15	D14	D13	D12	^H D11	D10	D9	D8	D7	D6	D5	D4	^L D3	D2	D1	D0
	YPI07	YPI06	YPI05	YPI04	YPI03	YPI02	YPI01	YPI00	XPI07	XPI06	XPI05	XPI04	XPI03	XPI02	XPI01	XPI00

D7~0 XPI07~0 Displaying the status of X axis general purpose input / output signals XPIO7~0.
When XPIO7~0 signals are set as input, it indicates the input state and when set as output, it indicates the output state.

D15~8 YPI07~0 Displaying the status of Y axis general purpose input / output signals YPIO7~0.
When YPIO7~0 signals are set as input, it indicates the input state and when set as output, it indicates the output state.

6.16 PIO Read Register 2: RR5

PIO read register RR5 is used for displaying the signal status of general purpose input / output signals ZPIO7~0 in Z axis and general purpose input / output signals UPIO7~0 in U axis. The bit is 0 if the signal is on the Low level; the bit is 1 if the signal is on the Hi level.

RR5	D15	D14	D13	D12	^H D11	D10	D9	D8	D7	D6	D5	D4	^L D3	D2	D1	D0
	UPI07	UPI06	UPI05	UPI04	UPI03	UPI02	UPI01	UPI00	ZPI07	ZPI06	ZPI05	ZPI04	ZPI03	ZPI02	ZPI01	ZPI00

D7~0 ZPI07~0 Displaying the status of Z axis general purpose input / output signals ZPIO7~0.
When ZPIO7~0 signals are set as input, it indicates the input state and when set as output, it indicates the output state.

D15~8 UPI07~0 Displaying the status of U axis general purpose input / output signals UPIO7~0.
When UPIO7~0 signals are set as input, it indicates the input state and when set as output, it indicates the output state.

6.17 Data-Read Register: RR6 / RR7

According to the data-read command, the data of internal registers will be set to registers RR6 and RR7. The low word 16 bits (RD15 ~ RD0) is set to RR6 register, and the high word 16 bits (RD31 ~ RD16) is set to RR7 register for data reading.

RR6	D15	D14	D13	D12	^H D11	D10	D9	D8	D7	D6	D5	D4	^L D3	D2	D1	D0
	RD15	RD14	RD13	RD12	RD11	RD10	RD9	RD8	RD7	RD6	RD5	RD4	RD3	RD2	RD1	RD0

RR7	D15	D14	D13	D12	^H D11	D10	D9	D8	D7	D6	D5	D4	^L D3	D2	D1	D0
	RD31	RD30	RD29	RD28	RD27	RD26	RD25	RD24	RD23	RD22	RD21	RD20	RD19	RD18	RD17	RD16

The data is binary and 2's complement is used for negative numbers.

7. Commands

7.1 Command Lists

■ Commands for Writing Data

Code	Command	Symbol	Data Range	Data Length (byte)
0 0 h	Jerk setting (Acceleration increasing rate)	J K	1 ~ 1, 073, 741, 823 [pps/sec ²]	4
0 1	Deceleration increasing rate setting	D J	1 ~ 1, 073, 741, 823 [pps/sec ²]	4
0 2	Acceleration setting	A C	1 ~ 536, 870, 911 [pps/sec]	4
0 3	Deceleration setting	D C	1 ~ 536, 870, 911 [pps/sec]	4
0 4	Initial speed setting	S V	1 ~ 8, 000, 000 [pps]	4
0 5	Drive speed setting	D V	1 ~ 8, 000, 000 [pps]	4
0 6	Drive pulse number / Finish point setting	T P	-2, 147, 483, 646 ~ +2, 147, 483, 646 (※ 1)	4
0 7	Manual deceleration point setting	D P	0 ~ 4, 294, 967, 292	4
0 8	Circular center point setting	C P	-1, 073, 741, 823 ~ +1, 073, 741, 823	4
0 9	Logical position counter setting	L P	-2, 147, 483, 648 ~ +2, 147, 483, 647	4
0 A	Real position counter setting	R P	-2, 147, 483, 648 ~ +2, 147, 483, 647	4
0 B	Software limit + setting	S P	-2, 147, 483, 647 ~ +2, 147, 483, 647	4
0 C	Software limit - setting	S M	-2, 147, 483, 647 ~ +2, 147, 483, 647	4
0 D	Acceleration counter offsetting	A O	-32, 768 ~ +32, 767	2
0 E	Logical position counter maximum value setting	L X	1 ~ 2, 147, 483, 647 (7FFF FFFFh) 0r FFFF FFFFh	4
0 F	Real position counter maximum value setting	R X	1 ~ 2, 147, 483, 647 (7FFF FFFFh) 0r FFFF FFFFh	4
1 0	Multi-purpose register 0 setting	M R 0	-2, 147, 483, 648 ~ +2, 147, 483, 647	4
1 1	Multi-purpose register 1 setting	M R 1	-2, 147, 483, 648 ~ +2, 147, 483, 647	4
1 2	Multi-purpose register 2 setting	M R 2	-2, 147, 483, 648 ~ +2, 147, 483, 647	4
1 3	Multi-purpose register 3 setting	M R 3	-2, 147, 483, 648 ~ +2, 147, 483, 647	4
1 4	Home search speed setting	H V	1 ~ 8, 000, 000 [pps]	4
1 5	Speed increasing / decreasing value setting	I V	1 ~ 1, 000, 000 [pps]	4
1 6	Timer value setting	T M	1 ~ 2, 147, 483, 647 [μ sec]	4
1 7	Split pulse setting 1	S P 1	Split length : 2 ~ 65, 535 Pulse width : 1 ~ 65, 534	4
1 8	Split pulse setting 2	S P 2	Split pulse number : 0 ~ 65, 535	2
1 9	Interpolation / Finish point maximum value setting	T X	1 ~ 1, 073, 741, 823	4
1 A	Helical rotation number setting	H L N	0 ~ 65, 535	2
1 B	Helical calculation value setting	H L V	1 ~ 2, 147, 483, 646	4

(※1) However the range of interpolation finish point data is -1, 073, 741, 823 ~ +1, 073, 741, 823.

[Note]

- When parameters are written, the total data length should be completely filled.
- The units described in speed parameters and the timer value are only applied to when input clock (CLK) is 16MHz. When input clock (CLK) is other than 16MHz, please see Appendix B for parameter calculation formula.

■ Commands for Writing Mode

Code	Command	Symbol	Data Length (byte)
2 0 h	Multi-purpose register mode setting	M R M	2
2 1	PIO signal setting 1	P 1 M	2
2 2	PIO signal setting 2 · Other settings	P 2 M	2
2 3	Automatic home search mode setting 1	H 1 M	2
2 4	Automatic home search mode setting 2	H 2 M	2
2 5	Input signal filter mode setting	F L M	2
2 6	Synchronous action SYNC0 setting	S 0 M	2
2 7	Synchronous action SYNC1 setting	S 1 M	2
2 8	Synchronous action SYNC2 setting	S 2 M	2
2 9	Synchronous action SYNC3 setting	S 3 M	2
2 A	Interpolation mode setting	I P M	2

[Note] When parameters are written, the total data length should be completely filled.

■ Commands for Reading Data

Code	Command	Symbol	Data Range	Data Length (byte)
3 0 h	Logical position counter reading	L P	-2, 147, 483, 648 ~ +2, 147, 483, 647	4
3 1	Real position counter reading	R P	-2, 147, 483, 648 ~ +2, 147, 483, 647	4
3 2	Current drive speed reading	C V	0 ~ 8, 000, 000 [pps]	4
3 3	Current acceleration / deceleration reading	C A	0 ~ 536, 870, 911 [pps/sec]	4
3 4	Multi-purpose register 0 reading	M R 0	-2, 147, 483, 648 ~ +2, 147, 483, 647	4
3 5	Multi-purpose register 1 reading	M R 1	-2, 147, 483, 648 ~ +2, 147, 483, 647	4
3 6	Multi-purpose register 2 reading	M R 2	-2, 147, 483, 648 ~ +2, 147, 483, 647	4
3 7	Multi-purpose register 3 reading	M R 3	-2, 147, 483, 648 ~ +2, 147, 483, 647	4
3 8	Current timer value reading	C T	0 ~ 2, 147, 483, 647 [μ sec]	4
3 9	Interpolation / Finish point maximum value reading	T X	1~1, 073, 741, 823	4
3 A	Current helical rotation number reading	C H L N	0 ~ 65, 535	2
3 B	Helical calculation value reading	H L V	1 ~ 2, 147, 483, 646	4
3 D	WR1 setting value reading	W R 1	(bit data)	2
3 E	WR2 setting value reading	W R 2	(bit data)	2
3 F	WR3 setting value reading	W R 3	(bit data)	2
4 0	Multi-purpose register mode setting reading	M R M	(bit data)	2
4 1	PIO signal setting 1 reading	P 1 M	(bit data)	2
4 2	PIO signal setting 2 / Other settings reading	P 2 M	(bit data)	2
4 3	Acceleration setting value reading	A C	1 ~ 536, 870, 911 [pps/sec]	4
4 4	Initial speed setting value reading	S V	1 ~ 8, 000, 000 [pps]	4
4 5	Drive speed setting value reading	D V	1 ~ 8, 000, 000 [pps]	4
4 6	Drive pulse number / Finish point setting value reading	T P	-2, 147, 483, 646 ~ +2, 147, 483, 646 (※1)	4
4 7	Split pulse setting 1 reading	S P 1	Split length : 2 ~ 65, 535 Pulse width : 1 ~ 65, 534	4
4 8	General purpose input value reading	U I	RR7: Lower byte (PIN7~0) RR6: 2 bytes (D15~0 in I2C communication)	4

(※1) However the range of interpolation finish point data is -1, 073, 741, 823 ~ +1, 073, 741, 823.

■ Driving Commands

Code	Command
5 0 h	Relative position driving
5 1	Counter relative position driving
5 2	+ Direction continuous pulse driving
5 3	- Direction continuous pulse driving
5 4	Absolute position driving
5 6	Decelerating stop
5 7	Instant stop
5 8	Direction signal + setting
5 9	Direction signal - setting
5 A	Automatic home search execution

■ Interpolation Commands

Code	Command
6 0 h	1-axis linear interpolation driving (multichip)
6 1	2-axis linear interpolation driving
6 2	3-axis linear interpolation driving
6 3	4-axis linear interpolation driving
6 4	CW circular interpolation driving
6 5	CCW circular interpolation driving
6 6	2-axis bit pattern interpolation driving
6 7	3-axis bit pattern interpolation driving
6 8	4-axis bit pattern interpolation driving
6 9	CW helical interpolation driving
6 A	CCW helical interpolation driving
6 B	CW helical calculation
6 C	CCW helical calculation
6 D	Deceleration enabling
6 E	Deceleration disabling
6 F	Interpolation interrupt clear / Single-step interpolation

■ Synchronous Action Operation Commands

Code	Command
8 1 ~ 8 F h	Synchronous action enable setting
9 1 ~ 9 F	Synchronous action disable setting
A 1 ~ A F	Synchronous action activation

■ Other Commands

Code	Command
7 0 h	Speed increase
7 1	Speed decrease
7 2	Deviation counter clear output
7 3	Timer-start
7 4	Timer-stop
7 5	Start of split pulse
7 6	Termination of split pulse
7 7	Drive start holding
7 8	Drive start holding release
7 9	Error / Finishing status clear
7 A	RR3 Page0 display
7 B	RR3 Page1 display
7 C	Maximum finish point clear
1 F	NOP
0 0 F F	Command reset

[Note] Please do not write the codes not mentioned above. The unknown situation could happen due to IC internal circuit test.

7.2 Commands for Writing Data

Commands for writing data is used for setting driving parameters such as acceleration, drive speed, drive pulse number... When more than one axis is specified, it is possible to set the same data in specified axes simultaneously.

If the data length is 2 bytes, WR6 register can be used. If the data is 4 bytes, the high word data can be written into register WR7 and the low word into register WR6. Then, the axis assignment and command code will be written into register WR0 for execution.

Writing data for registers WR6 and WR7 is binary and 2's complement is used for negative numbers. Each data should be set within the permitted data range. If the setting data is out of range, operation cannot be done correctly.

[Note]

- It requires 125 nSEC (maximum) to access the command code when CLK=16MHz. Please do not write the next command or data during the period of time.
- Except acceleration offset (AO), logical position counter maximum value (LX) and real position counter maximum value (RX), other parameters are unknown at reset. So, please set proper values for those driving related parameters before the driving starts.
- The unit described in each speed parameter and timer value is for when input clock (CLK) is 16MHz. Please see Appendix B for parameter calculation formula when input clock (CLK) is other than 16MHz.

7.2.1 Jerk Setting

Code	Command	Symbol	Data Range	Data Length (byte)
0 0 h	Jerk setting	J K	1 ~ 1, 073, 741, 823	4

A jerk setting value is a parameter that determines the acceleration increasing / decreasing rate per unit in S-curve acceleration/deceleration. The unit of the setting value is pps/sec².

$$\text{Jerk} = JK \text{ [pps/sec}^2\text{]}$$

In S-curve acceleration/deceleration driving (WR3/D1=0) where acceleration and deceleration are symmetrical, this jerk is also used at deceleration.

7.2.2 Deceleration Increasing Rate Setting

Code	Command	Symbol	Data Range	Data Length (byte)
0 1 h	Deceleration Increasing Rate Setting	D J	1 ~ 1, 073, 741, 823	4

This deceleration increasing rate value is a parameter used to determine a deceleration speed increase/decrease rate per unit time in S-curve acceleration/deceleration driving (WR3/D1= 1) where acceleration and deceleration are non-symmetrical. The unit of the setting value is pps/sec².

$$\text{Deceleration Increasing Rate} = DJ \text{ [pps/sec}^2\text{]}$$

In S-curve acceleration/deceleration driving (WR3/D1=0) where acceleration and deceleration are symmetrical, the deceleration increasing rate value is not used.

7.2.3 Acceleration Setting

Code	Command	Symbol	Data Range	Data Length (byte)
0 2 h	Acceleration setting	A C	1 ~ 536,870,911	4

An acceleration setting value is a parameter that determines acceleration in linear acceleration/deceleration driving. The unit of the setting value is pps/sec.

$$\text{Acceleration} = \text{AC} [\text{pps/sec}]$$

In linear acceleration/deceleration driving (WR3/D1=0) where acceleration and deceleration are symmetrical, this acceleration setting value is also used at deceleration.

For S-curve acceleration/deceleration driving, set the maximum value of 536,870,911 (1FFF FFFFh) to this parameter.

For Partial S-curve acceleration/deceleration driving, set the acceleration at linear acceleration part to this parameter.

In Partial S-curve acceleration/deceleration driving (WR3/D1=0) where acceleration and deceleration are symmetrical, this acceleration setting value is also used at deceleration.

The value of current acceleration can be read by current acceleration / deceleration reading command (33h).

An acceleration setting value can be read by acceleration setting value reading command (43h).

7.2.4 Deceleration Setting

Code	Command	Symbol	Data Range	Data Length (byte)
0 3 h	Deceleration setting	D C	1 ~ 536,870,911	4

This parameter is used to set a deceleration speed at deceleration in non-symmetrical linear acceleration/deceleration driving (WR3/D1=1). The unit of the setting value is pps/sec.

$$\text{Deceleration} = \text{DC} [\text{pps/sec}]$$

In non-symmetrical S-curve acceleration/deceleration driving, set the maximum value of 536,870,911 (1FFF FFFFh) to this parameter.

In non-symmetrical Partial S-curve acceleration/deceleration driving, set the deceleration at linear deceleration part to this parameter.

7.2.5 Initial Speed Setting

Code	Command	Symbol	Data Range	Data Length (byte)
0 4 h	Initial speed setting	S V	1 ~ 8,000,000	4

“SV” is the parameter determining the initial speed for the start of acceleration and the termination of deceleration. The unit of the setting value is pps.

$$\text{Initial Speed} = \text{SV [pps]}$$

For a stepper motor, the user should set the initial speed smaller than the self-starting frequency of a stepper motor. If there is the mechanical resonance frequency, set the initial speed to avoid it.

In fixed pulse driving, if the value which is too low is set to initial speed, premature termination or creep pulses may occur.

- In linear acceleration/deceleration driving, set the value more than square root of an acceleration setting value.
- In S-curve acceleration/deceleration driving, set the value more than 1/10 times the square root of a jerk setting value.
- In Partial S-curve acceleration/deceleration driving, set the value more than square root of an acceleration setting value.

Linear acceleration/deceleration driving $\text{SV} \geq \sqrt{\text{AC}}$, S-curve acceleration/deceleration driving $\text{SV} \geq \sqrt{\text{JK}} \times 1/10$,

Partial S-curve acceleration/deceleration driving $\text{SV} \geq \sqrt{\text{AC}}$

An initial speed setting value can be read by initial speed setting value reading command (44h).

7.2.6 Drive Speed Setting

Code	Command	Symbol	Data Range	Data Length (byte)
0 5 h	Drive speed setting	D V	1 ~ 8,000,000	4

“DV” is the parameter determining the speed of constant speed period in trapezoidal driving. In constant speed driving, the drive speed is the initial speed. The unit of the setting value is pps.

$$\text{Drive speed} = \text{DV [pps]}$$

If the drive speed is set with a lower value than the initial speed, the acceleration / deceleration will not be performed, and the driving is constant speed. If the user wants to perform instant stop immediately after the signal is detected during such as the encoder Z-phase search (at a low-speed driving), the drive speed must be set with lower than the initial speed.

A drive speed can be altered during the driving. When the drive speed of next constant speed period is newly set, the acceleration or deceleration is performed to reach the new setting speed, then a constant speed driving starts.

In automatic home search, this drive speed is used for high-speed search speed of Step 1 and high-speed drive speed of Step 4.

[Note]

- In fixed pulse S-curve acceleration / deceleration driving (when in auto deceleration mode) or in fixed pulse non-symmetrical linear acceleration / deceleration driving (when in auto deceleration mode), there is no way to change the drive speed during the driving.
- In continuous S-curve acceleration / deceleration driving, the drive speed can be changed in the constant speed period during the driving, but changing the drive speed during the acceleration / deceleration will be disabled.
- In fixed pulse symmetrical trapezoidal driving, the drive speed can be changed during the driving, set triangle form prevention function to disable (WR3/D13:1). The frequent changes of drive speed also may generate premature termination or creep.
- When changing the drive speed during interpolation driving, it can be changed by synchronous action.

The value of current drive speed during the driving can be read by current drive speed reading command (32h).

A drive speed setting value can be read by drive speed setting value reading command (45h).

7.2.7 Drive pulse number / Finish point setting

Code	Command	Symbol	Data Range	Data Length (byte)
0 6 h	Drive pulse number / finish point setting	T P	Drive pulse number/ Absolute position finish point : -2, 147, 483, 646 ~ +2, 147, 483, 646 Interpolation finish point : -1, 073, 741, 823~+1, 073, 741, 823	4

“TP” is the parameter setting the drive pulse number from the current position for relative position driving. When the positive pulse number is set as the drive pulse number, a drive direction is toward + direction, and when the negative pulse number is set, a drive direction is toward – direction.

In counter relative position driving, when the positive pulse number is set as the drive pulse number, a drive direction is toward – direction.

In absolute position driving, the destination point based on a home (logical position counter = 0) should be set with a signed 32-bit value.

Drive pulse number can be changed during relative position driving or counter relative position driving. However, it cannot be set to a different drive direction. Please note that if it is set to the position already passed, driving will stop immediately.

The finish point cannot be changed during absolute position driving.

In linear and circular interpolation driving, it sets the finish point of each axis. The finish point should be set the relative value to the current position with a signed 31-bit value.

In bit pattern interpolation driving, it sets the bit data of each axis. The lower 16 bits of 32 bits are used to set + direction bit data and the upper 16 bits are used to set – direction bit data.

In helical interpolation driving, it sets the finish point of X and Y axes and the drive pulse number of Z and U axes. The finish point should be set the relative value to the current position with a signed 31-bit value. The drive pulse number, when the rotation number is 0, it should be set the total amount of drive pulses with a signed 31-bit value, and when is 1, it should be set the drive pulse number per rotation with a signed 31-bit value.

7.2.8 Manual Decelerating Point Setting

Code	Command	Symbol	Data Range	Data Length (byte)
0 7 h	Manual decelerating point setting	D P	0 ~ 4, 294, 967, 292	4

“DP” is the parameter setting the manual deceleration point in fixed pulse acceleration / deceleration driving when the manual deceleration mode (WR3/D0=1) is engaged. As a manual decelerating point, set the value which subtracts pulse number to be used at deceleration from output pulse number in fixed pulse driving.

$$\text{Manual Decelerating Point} = \text{Output Pulse Number} - \text{Pulse Number for Deceleration}$$

<About output pulse number>

Output pulse number indicates the number of pulses which is actually output in fixed pulse driving.

In relative position driving, output pulse number P is the absolute value of drive pulse number setting value TP.

In absolute position driving, output pulse number P is the absolute value which reduces logical position counter value LP of before driving starts from drive pulse number setting value TP.

$$\text{Relative Position Driving} : \text{Output Pulse Number } P = | TP |$$

$$\text{Absolute Position Driving} : \text{Output Pulse Number } P = | TP - LP |$$

7.2.9 Circular Center Point Setting

Code	Command	Symbol	Data Range	Data Length (byte)
0 8 h	Circular center point setting	C P	-1, 073, 741, 823~+1, 073, 741, 823	4

“CT” is the parameter setting the center point in circular and helical interpolation driving. The coordinates of center point should be set the signed relative value to the current position.

7.2.10 Logical Position Counter Setting

Code	Command	Symbol	Data Range	Data Length (byte)
0 9 h	Logical position counter setting	L P	-2, 147, 483, 648 ~ +2, 147, 483, 647	4

“LP” is the parameter setting the value of logical position counter.

Logical position counter counts Up / Down according to the +/- direction pulse output.

A logical position counter setting value can be written anytime, and read by logical position counter reading command (30h) anytime.

7.2.11 Real Position Counter Setting

Code	Command	Symbol	Data Range	Data Length (byte)
0 A h	Real position counter setting	R P	-2, 147, 483, 648 ~ +2, 147, 483, 647	4

“RP” is the parameter setting the value of real position counter.

Real position counter counts Up / Down according to encoder input pulse.

A real position counter setting value can be written anytime, and read by real position counter reading command (31h) anytime.

7.2.12 Software Limit + Setting

Code	Command	Symbol	Data Range	Data Length (byte)
0 B h	Software limit + setting	S P	-2, 147, 483, 647 ~ +2, 147, 483, 647	4

“SP” is the parameter setting the value of + direction software limit SLMT+ register.

Enable / disable, an object to set, and stop mode of software limit can be set by WR2 register.

A software limit SLMT+ register setting value can be written anytime.

7.2.13 Software Limit – Setting

Code	Command	Symbol	Data Range	Data Length (byte)
0 Ch	Software limit – setting	S M	-2, 147, 483, 647 ~ +2, 147, 483, 647	4

“SM” is the parameter setting the value of – direction software limit SLMT– register.

Enable / disable, an object to set, and stop mode of software limit can be set by WR2 register.

A software limit SLMT– register setting value can be written anytime.

7.2.14 Acceleration Counter Offsetting

Code	Command	Symbol	Data Range	Data Length (byte)
0 Dh	Acceleration Counter Offsetting	A O	-32, 768 ~ +32, 767	2

“AO” is the parameter executing acceleration counter offset.

The offset value of acceleration counter will be set as 0 at reset. There is usually no need to change it.

See chapter 2.1 [■ Offset Setting for Acceleration/Deceleration Driving] for details of acceleration counter offsetting.

The data length of this writing command is 2 bytes. The setting value should only be written into WR6 register.

7.2.15 Logical Position Counter Maximum Value Setting

Code	Command	Symbol	Data Range	Data Length (byte)
0 Eh	Logical position counter maximum value setting	L X	1 ~ 2, 147, 483, 647 (7FFF FFFFh) 0r FFFF FFFFh	4

“LX” is the parameter setting the logical position counter maximum value with positive value for the variable ring function of logical position counter.

The value at reset is FFFF FFFFh. When the variable ring function is not used, the value should be default.

7.2.16 Real Position Counter Maximum Value Setting

Code	Command	Symbol	Data Range	Data Length (byte)
0 Fh	Real position counter maximum value setting	R X	1 ~ 2, 147, 483, 647 (7FFF FFFFh) 0r FFFF FFFFh	4

“RX” is the parameter setting the real position counter maximum value with positive value for the variable ring function of real position counter.

The value at reset is FFFF FFFFh. When the variable ring function is not used, the value should be default.

7.2.17 Multi-Purpose Register 0 Setting

Code	Command	Symbol	Data Range	Data Length (byte)
1 0 h	Multi-purpose register 0 setting	MR 0	-2, 147, 483, 648 ~ +2, 147, 483, 647	4

“MR0” is the parameter setting the value of multi-purpose register 0.

Multi-purpose register is used for comparison of position, speed, timer value and large or small, and load / save of each parameter as a synchronous action. Comparison result is used for comparative signal output, synchronous action activation and generating an interrupt.

A multi-purpose register MR0 setting value can be written anytime, and read by multi-purpose register 0 reading command (34h) anytime.

7.2.18 Multi-Purpose Register 1 Setting

Code	Command	Symbol	Data Range	Data Length (byte)
1 1 h	Multi-purpose register 1 setting	MR 1	-2, 147, 483, 648 ~ +2, 147, 483, 647	4

“MR1” is the parameter setting the value of multi-purpose register 1.

Multi-purpose register is used for comparison of position, speed, timer value and large or small, and load / save of each parameter as a synchronous action. Comparison result is used for outputting of comparison output signal, synchronous action activation and generating an interrupt.

A multi-purpose register MR1 setting value can be written anytime, and read by multi-purpose register 1 reading command (35h) anytime.

7.2.19 Multi-Purpose Register 2 Setting

Code	Command	Symbol	Data Range	Data Length (byte)
1 2 h	Multi-purpose register 2 setting	MR 2	-2, 147, 483, 648 ~ +2, 147, 483, 647	4

“MR2” is the parameter setting the value of multi-purpose register 2.

Multi-purpose register is used for comparison of position, speed, timer value and large or small, and load / save of each parameter as a synchronous action. Comparison result is used for outputting of comparison output signal, synchronous action activation and generating an interrupt.

A multi-purpose register MR2 setting value can be written anytime, and read by multi-purpose register 2 reading command (36h) anytime.

7.2.20 Multi-Purpose Register 3 Setting

Code	Command	Symbol	Data Range	Data Length (byte)
1 3 h	Multi-purpose register 3 setting	MR 3	-2, 147, 483, 648 ~ +2, 147, 483, 647	4

“MR3” is the parameter setting the value of multi-purpose register 3.

Multi-purpose register is used for comparison of position, speed, timer value and large or small, and load / save of each parameter as a synchronous action. Comparison result is used for outputting of comparison output signal, synchronous action activation and generating an interrupt.

A multi-purpose register MR3 setting value can be written anytime, and read by multi-purpose register 3 reading command (37h) anytime.

7.2.21 Home Search Speed Setting

Code	Command	Symbol	Data Range	Data Length (byte)
1 4 h	Home search speed setting	H V	1 ~ 8, 000, 000	4

“HV” is the parameter setting the low-speed home search speed that is applied in Steps 2 and 3. The unit of the setting value is pps.

$$\text{Home Search Speed} = \text{HV} [\text{pps}]$$

Set a lower value than the initial speed (SV) to stop driving immediately when a search signal becomes active.

See chapter 2.5 for details of automatic home search.

7.2.22 Speed Increasing / Decreasing Value Setting

Code	Command	Symbol	Data Range	Data Length (byte)
1 5 h	Speed increasing / decreasing value setting	I V	1 ~ 1, 000, 000	4

“IV” is the parameter setting the value to increase / decrease the current drive speed by speed increase command (70h) and speed decrease command (71h) during the driving. The unit of the setting value is pps.

$$\text{Speed Increasing / Decreasing Value} = \text{IV} [\text{pps}]$$

In acceleration / deceleration driving, the speed increase / decrease command is written at constant speed area, acceleration / deceleration is performed until it reaches the drive speed by this speed increasing /decreasing value setting, and then constant speed driving will start again.

7.2.23 Timer Value Setting

Code	Command	Symbol	Data Range	Data Length (byte)
1 6 h	Timer value setting	T M	1 ~ 2, 147, 483, 647	4

“TM” is the parameter setting the time that a timer is up. The unit of the setting value is μsec .

$$\text{Timer Value} = \text{TM} [\mu\text{sec}]$$

The current timer value during the timer operation can be read by current timer value reading command (38h).

7.2.24 Split Pulse Setting 1

Code	Command	Symbol	Data Range	Data Length (byte)
1 7 h	Split pulse setting 1	S P 1	WR6 Split length : 2 ~ 65, 535	4
			WR7 Pulse width : 1 ~ 65, 534	

“SP1” is the parameter setting a split length and pulse width of a split pulse.

The unit of split length and pulse width is drive pulse. Set a split length to WR6 and pulse width to WR7.

Split length and pulse width can be altered during output of split pulse. When split length and pulse width are newly set, output of split pulse will continue at the new settings.

This data length is 4 bytes, so even if only one of split length and pulse width is altered, the appropriate data should be set to both WR6 and WR7 registers.

The value of split pulse setting 1 (SP1) can be read by split pulse setting 1 reading command (47h).

7.2.25 Split Pulse Setting 2

Code	Command	Symbol	Data Range	Data Length (byte)
1 8 h	Split pulse setting 2	S P 2	Split pulse number : 0, 1 ~ 65, 535	2

“SP2” is the parameter setting the split pulse number to output. When the split pulse number is set as 0, it continues to output split pulses until the output of split pulse is stopped by a command or synchronous action.

The split pulse number can be altered during output of split pulse.

This data length is 2 bytes, the setting data should be written into WR6 register.

7.2.26 Interpolation / Finish Point Maximum Value Setting

Code	Command	Symbol	Data Range	Data Length (byte)
1 9h	Interpolatopn / Finish point maximum value setting	T X	1~1, 073, 741, 823	4

“TX” is the parameter setting the maximum value of finish point in linear interpolation. It does not require axis assignment, and should be set with an unsigned 31-bit value.

The linear interpolation is calculated based on the value set by this command.

When using this command, the linear interpolation maximum value must be manually set by interpolation mode setting command (2Ah).

7.2.27 Helical rotation number setting

Code	Command	Symbol	Data Range	Data Length (byte)
1 Ah	Helical rotation number setting	H L N	0~65, 535	2

“HLN” is the parameter setting the helical rotation number during helical interpolation. It does not require axis assignment. The helical rotation number during helical interpolation can be read by current helical rotation number reading command (3Ah).

7.2.28 Helical calculation setting

Code	Command	Symbol	Data Range	Data Length (byte)
1 Bh	Helical calculation setting	H L V	1 ~ 2, 147, 483, 646	4

“HLV” is the parameter setting the helical calculation value during helical interpolation. It does not require axis assignment.

See chapter 3.3 for details of helical interpolation.

7.3 Commands for Writing Mode

Commands for writing mode is used for setting driving parameters such as multi-purpose register, automatic home search, synchronous action and interpolation driving. When more than one axis is specified, it is possible to set the same data to specified axes simultaneously. Interpolation mode setting does not need axis assignment.

The data length of commands for writing mode is all 2 bytes. Set an appropriate value to each bit of WR6 register and write a command code into WR0 register. As a result, the data of WR6 register will be set to each mode setting register in the IC.

At reset, all the bits of each mode setting register in the IC are cleared to 0.

[Note]

- It requires 125 nSEC (maximum) to access the command code when CLK=16MHz. Please do not write the next command or data during the period of time.

7.3.1 Multi-Purpose Register Mode Setting

Code	Command	Symbol	Data Length (byte)
2 0h	Multi-purpose register mode setting	MRM	2

“MRM” is the parameter setting the comparative object with multi-purpose register MR3~0 and the comparison condition. The user can set the comparative object and comparison condition for each MR3~0 individually. Comparison result can be used for comparative signal output, the factor of synchronous action activation and an interrupt.

WR6	D15	D14	D13	D12 ^H	D11	D10	D9	D8	D7	D6	D5	D4 ^L	D3	D2	D1	D0
	M3C1	M3C0	M3T1	M3T0	M2C1	M2C0	M2T1	M2T0	M1C1	M1C0	M1T1	M1T0	M0C1	M0C0	M0T1	M0T0
	MR3 comparison condition		MR3 comparative object		MR2 comparison condition		MR2 comparative object		MR1 comparison condition		MR1 comparative object		MR0 comparison condition		MR0 comparative object	

D1, 0 M0T1, 0 Setting the comparative object with MR0. (k:0~3)

D3, 2 M0C1, 0 Setting the comparison condition with MR0.

MkT1 bit	MkT0 bit	MRm comparative object
0	0	Logical position counter (LP)
0	1	Real position counter (RP)
1	0	Current drive speed value (CV)
1	1	Current timer value (CT)

D5, 4 M1T1, 0 Setting the comparative object with MR1.

D7, 6 M1C1, 0 Setting the comparison condition with MR1

D9, 8 M2T1, 0 Setting the comparative object with MR2. (k:0~3)

D11, 10 M2C1, 0 Setting the comparison condition with MR2.

MkC1 bit	MkC0 bit	MRm comparison condition
0	0	comparative object \geq MRm
0	1	comparative object $>$ MRm
1	0	comparative object $=$ MRm
1	1	comparative object $<$ MRm

D13, 12 M3T1, 0 Setting the comparative object with MR3.

D15, 14 M3C1, 0 Setting the comparison condition with MR3.

Regardless of the comparison condition (MnC1, 0 bits) set by multi-purpose register mode setting, MR3~0 and the comparison result of large or small with each comparative object can be checked by RR4 register.

See chapter 2.4 for details of multi-purpose register.

[Note]

- When the comparative object is set as “current drive speed value (CV)” and comparison condition is set as “comparative object = MRm”, if the acceleration/deceleration exceeds 4,194,304 (400000h) pps/sec in acceleration/deceleration driving, the comparison result may not become active.
When the comparative object is “current drive speed value (CV)” and the acceleration/deceleration is more than this value, set the other conditions such as “comparative object \geq MRm” and not “comparative object = MRm”.

D15~D0 will be set as 0 at reset.

7.3.2 PIO Signal Setting 1

Code	Command	Symbol	Data Length (byte)
2 1 h	PIO signal setting 1	P 1 M	2

“P1M” is the parameter setting the function of nPIO7~0 signals. nPIO7~0 signals can be used for the general purpose input / output signals, synchronous input signals, synchronous pulse output signals, drive status output signals, MRm comparison output signals and driving by external signals.

WR6	D15	D14	D13	D12 ^H	D11	D10	D9	D8	D7	D6	D5	D4 ^L	D3	D2	D1	D0
		P7M1	P7M0	P6M1	P6M0	P5M1	P5M0	P4M1	P4M0	P3M1	P3M0	P2M1	P2M0	P1M1	P1M0	P0M1
	nPIO7 signal		nPIO6 signal		nPIO5 signal		nPIO4 signal		nPIO3 signal		nPIO2 signal		nPIO1 signal		nPIO0 signal	

D1, 0	P0M1, 0	Setting the nPIO0 signal function.
D3, 2	P1M1, 0	Setting the nPIO1 signal function.
D5, 4	P2M1, 0	Setting the nPIO2 signal function.
D7, 6	P3M1, 0	Setting the nPIO3 signal function.
D9, 8	P4M1, 0	Setting the nPIO4 signal function.
D11, 10	P5M1, 0	Setting the nPIO5 signal function.
D13, 12	P6M1, 0	Setting the nPIO6 signal function.
D15, 14	P7M1, 0	Setting the nPIO7 signal function.

Each function is shown as follows.

PkM1 bit	PkM0 bit	Function
0	0	General purpose input nPIO7~0 signals become an input state. The signal level of each axis can be read by the following register: X axis from D7~0 of RR4, Y axis from D15~8 of RR4, Z axis from D7~0 of RR5 and U axis from D15~8 of RR5 register. In synchronous action, it can be activated by the signals ↑ or ↓. In driving by external signals, relative position driving or continuous pulse driving can be activated by nPIO4, 5 signals.
0	1	General purpose output nPIO7~0 signals become an output state. The values of WR4, 5 registers are output to the following bit of each axis respectively: D7~0 of WR4 are output to PIO7~0 of X axis, D15~8 of WR4 to PIO7~0 of Y axis, D7~0 of WR5 to PIO 7~0 of Z axis and D15~8 of WR5 to PIO7~0 of U axis. When the value is 0, it is Low level output and when is 1, it is Hi level output.
1	0	Drive status output nPIO7~0 signals become an output state and each signal outputs the drive status as shown in the following table.
1	1	Synchronous pulse · MRm comparison output nPIO7~0 signals become an output state. nPIO3~0 output synchronous pulses and nPIO7~4 output MRm comparison value. The comparative object and comparison condition can be set by multi-purpose register mode setting command (20h).

The function of each nPIOm signal is shown as follows.

(k:0~7)

nPIOm Signal (Pin Number)	PkM1,0 = 0,0	PkM1,0 = 0,1	PkM1,0 = 1,0	PkM1,0 = 1,1
	General Purpose Input *Note	General Purpose Output	Drive Status Output (True = Hi)	Synchronous Pulse Output, MRm Comparison Output
XPIO0(63) YPIO0(82) ZPIO0(101) UPIO0(120)	X axis : RR4/D0 Y axis : RR4/D8 Z axis : RR5/D0 U axis : RR5/D8 signal level reading	X axis : WR4/D0 Y axis : WR4/D8 Z axis : WR5/D0 U axis : WR5/D8 value output	Driving	SYNC0 Synchronous pulse output
XPIO1(62) YPIO1(81) ZPIO1(100) UPIO1(119)	X axis : RR4/D1 Y axis : RR4/D9 Z axis : RR5/D1 U axis : RR5/D9 signal level reading	X axis : WR4/D1 Y axis : WR4/D9 Z axis : WR5/D1 U axis : WR5/D9 value output	Error	SYNC1 Synchronous pulse output
XPIO2(61) YPIO2(80) ZPIO2(99) UPIO2(118)	X axis : RR4/D2 Y axis : RR4/D10 Z axis : RR5/D2 U axis : RR5/D10 signal level reading	X axis : WR4/D2 Y axis : WR4/D10 Z axis : WR5/D2 U axis : WR5/D10 value output	Accelerating	SYNC2 Synchronous pulse output
XPIO3(60) YPIO3(79) ZPIO3(98) UPIO3(117)	X axis : RR4/D3 Y axis : RR4/D11 Z axis : RR5/D3 U axis : RR5/D11 signal level reading	X axis : WR4/D3 Y axis : WR4/D11 Z axis : WR5/D3 U axis : WR5/D11 value output	Constant speed driving	SYNC3 Synchronous pulse output
XPIO4(59) YPIO4(78) ZPIO4(97) UPIO4(116)	X axis : RR4/D4 Y axis : RR4/D12 Z axis : RR5/D4 U axis : RR5/D12 signal level reading	X axis : WR4/D4 Y axis : WR4/D12 Z axis : WR5/D4 U axis : WR5/D12 value output	Decelerating	MR0 comparison output (True = Hi)
XPIO5(58) YPIO5(77) ZPIO5(96) UPIO5(115)	X axis : RR4/D5 Y axis : RR4/D13 Z axis : RR5/D5 U axis : RR5/D13 signal level reading	X axis : WR4/D5 Y axis : WR4/D13 Z axis : WR5/D5 U axis : WR5/D13 value output	Acceleration increasing	MR1 comparison output (True = Hi)
XPIO6(57) YPIO6(76) ZPIO6(95) UPIO6(114)	X axis : RR4/D6 Y axis : RR4/D14 Z axis : RR5/D6 U axis : RR5/D14 signal level reading	X axis : WR4/D6 Y axis : WR4/D14 Z axis : WR5/D6 U axis : WR5/D14 value output	Acceleration Constant	MR2 comparison output (True = Hi)
XPIO7(56) YPIO7(75) ZPIO7(94) UPIO7(113)	X axis : RR4/D7 Y axis : RR4/D15 Z axis : RR5/D7 U axis : RR5/D15 signal level reading	X axis : WR4/D7 Y axis : WR4/D15 Z axis : WR5/D7 U axis : WR5/D15 value output	Acceleration decreasing	MR3 comparison output (True = Hi)

See chapter 2.8 General Purpose Input / Output Signals for details of nPIO7~0 signals.

[Note]

- When nPIO7~0 signals are general purpose input mode (PkM1,0 = 0,0), it can be used as activation factor of a synchronous action. See chapter 2.6 for more details.
- When nPIO4, 5 signals are general purpose input mode (PkM1,0 = 0,0), it can be used as input signals (nEXPP, nEXPM input) for driving by external signals. See chapter 2.12.1 for more details.

D15~D0 will be set as 0 at reset.

7.3.3 PIO Signal Setting 2 · Other Settings

Code	Command	Symbol	Data Length (byte)
2 2 h	PIO signal setting 2 · Other settings	P 2 M	2

“P2M” is the parameter setting the logical level of a synchronous pulse and pulse width. In addition, it can set the synchronous action disabling when an error occurs, the mode setting for driving by external signals, the logical level of split pulse output and with or without starting pulse.

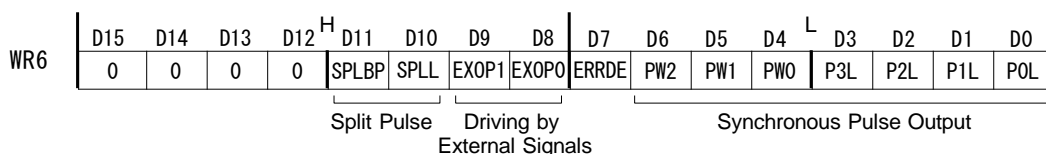

D3~0 PnL Setting the logical level of pulses for when nPIOm (m : 3~0) is used as synchronous pulse output signal.
 0: positive logical pulse, 1: negative logical pulse



D6~4 PW2~0 Setting the output pulse width of synchronous pulse output signal.

(When CLK=16MHz)	
D6~4 (PW2~0)	Output Pulse Width
0	125 n sec
1	312 n sec
2	1µsec
3	4µsec
4	16µsec
5	64µsec
6	256µsec
7	1msec

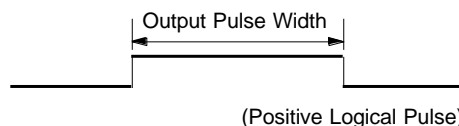

D7 ERRDE Setting for whether the enabling status of synchronous action SYNC3~0 is disabled or not when an error occurs (RR0/D7~4 : n-ERR = 1).

0: not disable at the error, 1: disable at the error

When this bit is set as 1, and when n-ERR bit of RR0 register becomes 1, synchronous action SYNC3~0 are all disabled immediately.

When n-ERR bit of RR0 register is 1, synchronous action SYNC3~0 cannot be enabled again. Clear the error bit by such as the error/finishing status clear command (79h) and then set the synchronous action enable setting.

Error status and enable / disable setting of synchronous action SYNC3~0 can be checked by Page 1 of RR3 register.

D9, 8 EXOP1, 0 Setting the external input signals (nEXPP, nEXPM) for driving.

D9(EXOP1)	D8(EXOP0)	Driving mode by external signals
0	0	Driving disabled by external signals
0	1	Continuous driving mode
1	0	Relative position driving mode
1	1	Manual pulsar mode

- D10 SPLL The logical level of split pulse output.
0: positive logical pulse, 1: negative logical pulse

Positive Logical Pulse :  Negative Logical Pulse : 

- D11 SPLBP With or without starting pulse of split pulse output.
0: without starting pulse, 1: with starting pulse

D15~D0 will be set as 0 at reset. D15~D12 should always be set as 0.

7.3.4 Automatic Home Search Mode Setting 1

Code	Command	Symbol	Data Length (byte)
2 3 h	Automatic home search mode setting 1	H 1 M	2

“H1M” is the parameter setting the automatic home search mode. Enable / disable of each step for automatic home search, search direction, stop signal selectable, enable / disable of deviation counter clear output and position counter clear.

WR6	D15	D14	D13	D12 ^H	D11	D10	D9	D8	D7	D6	D5	D4 ^L	D3	D2	D1	D0
	S4EN	S3LC	S3RC	S3DC	S3DR	S3EN	S2LC	S2RC	S2DC	S2SG	S2DR	S2EN	S1G1	S1G0	S1DR	S1EN
	Step 4			Step 3			Step 2				Step 1					

- D0 S1EN Setting for whether “high-speed search” of step 1 in the automatic home search is executed or not.
0: non-execution, 1: execution
- D1 S1DR The search direction of step 1.
0: + direction, 1: – direction
- D3, 2 S1G1, 0 The search signal of step 1.
Use the WR2 register for logical setting of the input signal that is detected.

D3(S1G1)	D2(S1G0)	Search Signal
0	0	nSTOP0
0	1	nSTOP1
1	0	Limit signal *
1	1	(Invalid)

* If a limit signal is specified, the limit signal in the search direction specified by D1(S1DR) will be selected.

- D4 S2EN Setting for whether “low-speed search” of step 2 in the automatic home search is executed or not.
0: non-execution, 1: execution
- D5 S2DR The search direction of step 2.
0: + direction, 1: – direction
- D6 S2SG The search signal of step 2.
Use the WR2 register for logical setting of the input signal that is detected.

D6(S2SG)	Search Signal
0	nSTOP1
1	Limit signal *

* If a limit signal is specified, the limit signal in the search direction specified by D5(S2DR) will be selected.

D7	S2DC	Setting for whether the deviation counter clear (nDCC) signal is output or not in the signal detection of step 2. 0: non-output, 1: output
D8	S2RC	Setting for whether the real position counter is cleared or not in the signal detection of step 2. 0: non-clear, 1: clear
D9	S2LC	Setting for whether the logical position counter is cleared or not in the signal detection of step 2. 0: non-clear, 1: clear
D10	S3EN	Setting for whether “low-speed Z-phase search” of step 3 in the automatic home search is executed or not. 0: non-execution, 1: execution
D11	S3DR	The search direction of step 3. 0: + direction, 1: – direction
D12	S3DC	Setting for whether the deviation counter clear (nDCC) signal is output or not in nSTOP2 signal detection of step 3. 0: non-output, 1: output
D13	S3RC	Setting for whether the real position counter is cleared or not in nSTOP2 signal detection of step 3. 0: non-clear, 1: clear
D14	S3LC	Setting for whether the logical position counter is cleared or not in nSTOP2 signal detection of step 3. 0: non-clear, 1: clear
D15	S4EN	Setting for whether “high-speed offset drive” of step 4 in the automatic home search is executed or not. 0: non-execution, 1: execution

For more details of the automatic home search, see chapter 2.5 and 2.5.4.
D15~D0 will be set as 0 at reset.

7.3.5 Automatic Home Search Mode Setting 2

Code	Command	Symbol	Data Length (byte)
2 4 h	Automatic home search mode setting 2	H 2 M	2

“H2M” is the parameter setting the automatic home search mode. The stop condition for automatic home search of step 3, position counter clear, deviation counter clear output and the timer between steps.

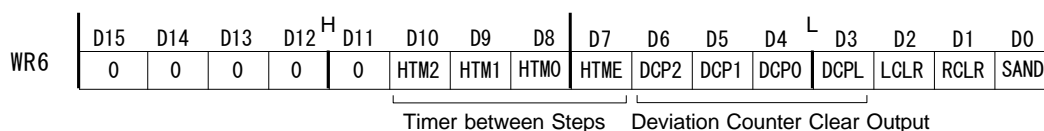

D0	SAND	When this bit is set as 1, and when nSTOP1 signal is active and nSTOP2 signal changes to active, the operation of step 3 will stop. This is only enabled when nSTOP1 signal is selected as the search signal of step 2, when a limit signal is selected, it cannot be enabled.
D1	RCLR	Setting for whether the real position counter is cleared or not at the end of automatic home search. 0: non-clear, 1: clear

- D2 LCLR Setting for whether the logical position counter is cleared or not at the end of automatic home search.
0: non-clear, 1: clear
- D3 DCPL Setting the logical level of deviation counter clear (nDCC) output pulses.
0: positive logical pulse, 1: negative logical pulse

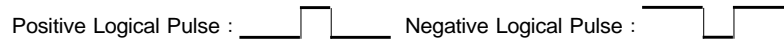

- D6~4 DCP2~0 Setting the output pulse width of deviation counter clear (nDCC).

(When CLK=16MHz)

D6~4 (DCP2~0)	Output Pulse Width
0	10μsec
1	20μsec
2	100μsec
3	200μsec
4	1msec
5	2msec
6	10msec
7	20msec

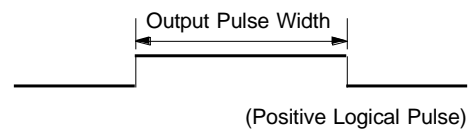

- D7 HTME Enables the timer between steps.
0: disable, 1: enable
- D10~8 HTM2~0 Specifies the interval of the timer between steps.

(When CLK=16MHz)

D10~8 (HTM2~0)	Timer Time
0	1msec
1	2msec
2	10msec
3	20msec
4	100msec
5	200msec
6	500msec
7	1000msec

For more details of the automatic home search, see chapter 2.5 and 2.5.4.
D15~D0 will be set as 0 at reset. D15~D11 should always be set as 0.

7.3.6 Input Signal Filter Mode Setting

Code	Command	Symbol	Data Length (byte)
2 5 h	Input signal filter mode setting	F L M	2

“FLM” is the parameter setting the enable / disable of input signal filter and the time constant of 2 filters.

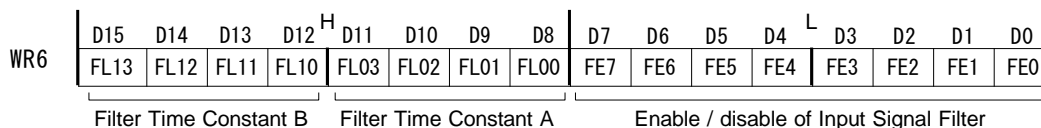

D7~0 FE7~0 For each input signals as shown in the table below, it can set whether the IC built-in filter function is enabled or the signal is passed through.

0: disable (through), 1: enable

Specified bit	Input signal	Applied time constant
D0(FE0)	EMGN	Filter Time Constant A
D1(FE1)	nLMTP, nLMTM	
D2(FE2)	nSTOP0, nSTOP1	
D3(FE3)	nINPOS, nALARM	
D4(FE4)	nPIO3~0	
D5(FE5)	nPIO7~4	Filter Time Constant B
D6(FE6)	nSTOP2	
D7(FE7)	nECA, nECB	

D11~8 FL03~00 Set the time constant of the input signal filter specified by D5~D0 (FE5~0) to Filter Time Constant A.

D15~12 FL13~10 Set the time constant of the input signal filter specified by D7, D6 (FE7, 6) to Filter Time Constant B.

(When CLK=16MHz)

Time Constant (Hex)	Removable maximum noise width	Input signal delay time
0	437.5nsec	500nsec
1	875nsec	1μsec
2	1.75μsec	2μsec
3	3.5μsec	4μsec
4	7μsec	8μsec
5	14μsec	16μsec
6	28μsec	32μsec
7	56μsec	64μsec
8	112μsec	128μsec
9	224μsec	256μsec
A	448μsec	512μsec
B	896μsec	1.024msec
C	1.792msec	2.048msec
D	3.584msec	4.096msec
E	7.168msec	8.192msec
F	14.336msec	16.384msec

As for EXPLSN, PIN7~0 input signals, filter function is not available.
See chapter 2.11 for details of input signal filter function.

D15~D0 will be set as 0 at reset.

7.3.7 Synchronous Action SYNC0, 1, 2, 3 Setting

Code	Command	Symbol	Data Length (byte)
2 6 h	Synchronous action SYNC0 setting	S 0 M	2
2 7 h	Synchronous action SYNC1 setting	S 1 M	2
2 8 h	Synchronous action SYNC2 setting	S 2 M	2
2 9 h	Synchronous action SYNC3 setting	S 3 M	2

These parameters are used to set the synchronous action SYNC0, 1, 2, 3 mode. The activation factor of each synchronous action set, actions, the activation of other synchronous action sets, the activation of another axis SYNC0 and the setting for whether the synchronous action is performed once or repeatedly.

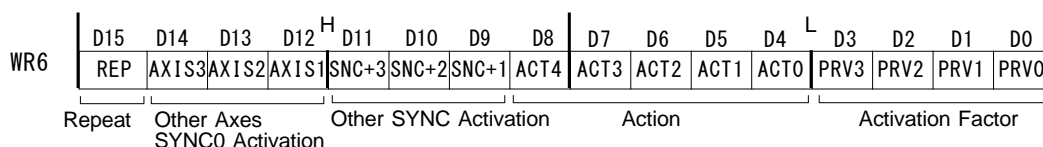

D3~0 PRV3~0 It designates the activation factor of a synchronous action by code.

(m : 0, 1, 2, 3)

Code (Hex)	Activation factor in SYNCm	Code (Hex)	Activation factor in SYNCm
0	NOP	8	Termination of split pulse
1	MRm comparison changed to True	9	Output of split pulse
2	Timer is up	A	nPIOm input ↑
3	Start of driving	B	nPIOm input ↓
4	Start of driving at constant speed area	C	nPIO(m+4) input Low and nPIOm input ↑
5	Termination of driving at constant speed area	D	nPIO(m+4) input Hi and nPIOm input ↑
6	Termination of driving	E	nPIO(m+4) input Low and nPIOm input ↓
7	Start of split pulse	F	nPIO(m+4) input Hi and nPIOm input ↓

For more details of the activation factor of a synchronous action and setting code, see chapter 2.6.1.

D8~4 ACT4~0 It designates the action of a synchronous action by code.

(m : 0, 1, 2, 3)

Code (Hex)	Action in SYNCm	Code (Hex)	Action in SYNCm
00	NOP	0C	Start of absolute position driving
01	Load MRm → DV	0D	Start of + direction continuous pulse driving
02	Load MRm → TP	0E	Start of - direction continuous pulse driving
03	Load MRm → SP1	0F	Relative position driving by drive pulse number of MRm value
04	Load MRm → LP(SYNC0), RP(SYNC1), SV(SYNC2), AC(SYNC3)	10	Absolute position driving to the finish point of MRm value
		11	Decelerating stop
05	Save LP → MRm	12	Instant stop
06	Save RP → MRm	13	Drive speed increase
07	Save CT → MRm	14	Drive speed decrease
08	Save CV(SYNC0), CA(SYNC1) → MRm	15	Timer-start

09	Synchronous pulse nPIOm output	16	Timer-stop
0A	Start of relative position driving	17	Start of split pulse
0B	Start of counter relative position driving	18	Termination of split pulse

DV : Drive speed	TP : Drive pulse number / Finish point	SP1 : Split pulse setting 1
LP : Logical position counter	RP : Real position counter	SV : Initial speed
AC : Acceleration	CT : Current timer value	CV : Current drive speed
CA : Current acceleration / deceleration		

For more details of the action of synchronous action and setting code, see chapter 2.6.2.

D11~9 SNC+3~1 It designates the other synchronous action sets activated by a synchronous action.
0: disable, 1: enable

Self- synchronous action set	D11(SNC+3)	D10(SNC+2)	D9(SNC+1)
SYNC0	SYNC3 activation	SYNC2 activation	SYNC1 activation
SYNC1	SYNC0 activation	SYNC3 activation	SYNC2 activation
SYNC2	SYNC1 activation	SYNC0 activation	SYNC3 activation
SYNC3	SYNC2 activation	SYNC1 activation	SYNC0 activation

D14~12 AXIS3~1 It designates another axis SYNC0 activated by a synchronous action.
0: disable, 1: enable

Own Axis	D14(AXIS3)	D13(AXIS2)	D12(AXIS1)
X	U axis SYNC0 activation	Z axis SYNC0 activation	Y axis SYNC0 activation
Y	X axis SYNC0 activation	U axis SYNC0 activation	Z axis SYNC0 activation
Z	Y axis SYNC0 activation	X axis SYNC0 activation	U axis SYNC0 activation
U	Z axis SYNC0 activation	Y axis SYNC0 activation	X axis SYNC0 activation

D15 REP Setting for whether the enable state of synchronous action set is disabled or not once the synchronous action is activated.

0: disable (once), 1: non-disable (repeat)

When this bit is set as 0, and when the activation factor becomes active, the synchronous action is activated only the first time. When this bit is set as 1, the synchronous action is activated whenever the activation factor becomes active.

To re-enable the synchronous action that is disabled, write a synchronous action enable command.
Enable / disable setting of synchronous action SYNC3~0 can be checked by RR0 register.

For more details of the synchronous action, see chapter 2.6.

D15~D0 will be set as 0 at reset.

7.3.8 Interpolation Mode Setting

Code	Command	Symbol	Data Length (byte)
2 Ah	Interpolation mode setting	I P M	2

“IPM” is the parameter setting the mode for interpolation driving. It does not need axis assignment.

WR6	D15	D14	D13	D12 ^H	D11	D10	D9	D8	D7	D6	D5	D4 ^L	D3	D2	D1	D0
	INTB	INTA	0	MAXM	MLT1	MLT0	STEP	LMDF	SPD1	SPD0	0	CXIV	U-EN	Z-EN	Y-EN	X-EN

D3~0 U-EN~X-EN Axis assignment for interpolation driving. The axis corresponding to the bit is shown in the table below.

0: not used as interpolation axis, 1: used as interpolation axis

Axis	Bit
X	D0
Y	D1
Z	D2
U	D3

Main axis priority is X-EN > Y-EN > Z-EN > U-EN in order, and the bit1:1 is selected.

D4 CXIV Specify whether interpolation is performed by exchanging the interpolation axis when circular interpolation is performed.

0: not exchange the interpolation axis, 1: exchange the interpolation axis

D7, 6 SPD1, 0 Setting constant vector speed mode for interpolation driving.

D7(SPD1)	D6(SPD0)	Constant Vector Speed Type
0	0	invalid
0	1	2-axis simple
1	0	3-axis simple
1	1	2-axis high-accuracy

D8 LMDF Setting short axis pulse equalization mode for interpolation driving.
0: disable, 1: enable

D9 STEP Setting the external signal / single-step command for interpolation driving.
0: disable, 1: enable
When this bit is 1, interpolation driving becomes the single-step mode controlled by the external signal (EXPLSN) or single-step interpolation command (6Fh).

D11, 10 MLT1, 0 Setting multichip interpolation.

D11(MLT1)	D10(MLT0)	Operation of multichip interpolation
0	0	invalid
0	1	Main chip
1	0	Sub chip
1	1	—

When using multichip interpolation, set 01 to main chip and 10 to others (sub chip).
When not using multichip interpolation, set 00.

D12 MAXM Specifies the setting of the linear interpolation maximum value.

0: Automatic setting, 1: Manual setting

When using manual setting, set the finish point maximum value by interpolation / finish point maximum value setting command (19h).

D15, 14 INTB, A

Setting an interrupt during continuous interpolation driving.

Use when the user wants to generate an interrupt in response to a change of pre-buffer stack counter.

D15(INT1)	D14(INT0)	Interrupt during Interpolation
0	0	Invalid
0	1	stack counter 4 → 3
1	0	stack counter 8 → 7
1	1	stack counter 8 → 7 stack counter 4 → 3

When an interrupt occurs, interpolation interrupt output signal (INT1N) becomes Low level. After cleared by interpolation interrupt clear command, interpolation execution command for next node or at the timing continuous interpolation driving is finished, interpolation interrupt output signal returns to non-active level.

[Note]

- When terminating interpolation driving, write 0 in WR6 register and write this mode setting command, then be sure to clear interpolation mode. Otherwise, driving will not work properly.

D15~D0 will be set as 0 at reset. D5, 13 should always be set as 0.

7.4 Commands for Reading Data

Commands for reading data are used to read the internal register.

After a data reading command is written into register WR0, this data will be set to registers RR6 and RR7.

The user can obtain a specified data by reading the registers RR6 and RR7. When the data length is 2 bytes, the data will be set to register RR6 and when it is 4 bytes, the data will be set to registers RR6 and RR7.

Reading data is binary and 2's complement is used for negative numbers.

[Note]

- It requires 125 nSEC (maximum) to access the command code of data reading when CLK = 16MHz. After the command is written and passed that time, read registers RR6 and 7.
- The unit described in each speed parameter and timer value is for when input clock (CLK) is 16MHz. Please see Appendix B for parameter calculation formula when input clock (CLK) is other than 16MHz.
- The axis assignment should be only 1 axis.

7.4.1 Logical Position Counter Reading

Code	Command	Symbol	Data Range	Data Length (byte)
3 0h	Logical position counter reading	L P	-2, 147, 483, 648 ~ +2, 147, 483, 647	4

The current value of logical position counter is set to read registers RR6 and RR7.

7.4.2 Real Position Counter Reading

Code	Command	Symbol	Data Range	Data Length (byte)
3 1h	Real position counter reading	R P	-2, 147, 483, 648 ~ +2, 147, 483, 647	4

The current value of real position counter is set to read registers RR6 and RR7.

7.4.3 Current Drive Speed Reading

Code	Command	Symbol	Data Range	Data Length (byte)
3 2h	Current drive speed reading	C V	0 ~ 8, 000, 000	4

The value of current drive speed is set to read registers RR6 and RR7.

When the driving stops, the value becomes 0. The unit of the setting value is pps which is the same as Drive speed setting (DV).

During interpolation driving, calculated pulse speed of the main axis can be read, other axes cannot be read.

7.4.4 Current Acceleration / Deceleration Reading

Code	Command	Symbol	Data Range	Data Length (byte)
3 3 h	Current acceleration / deceleration reading	C A	0 ~ 536,870,911	4

In acceleration / deceleration driving, the value of current acceleration speed during acceleration and current deceleration speed during deceleration is set to read registers RR6 and RR7. While driving stops, 0 will be read out.

The unit of the setting value is pps/sec which is the same as Acceleration setting (AC) and Deceleration setting (DC).

[Note]

- At constant speed area in linear acceleration / deceleration driving (symmetrical), the acceleration setting value will always be read out.
- At constant speed area in S-curve acceleration / deceleration driving, the read value will be invalid.

7.4.5 Multi-Purpose Register 0 Reading

Code	Command	Symbol	Data Range	Data Length (byte)
3 4 h	Multi-purpose register 0 reading	MR 0	-2, 147, 483, 648 ~ +2, 147, 483, 647	4

The value of multi-purpose register MR0 is set to read registers RR6 and RR7.

It can be used to read out the current position, timer value and speed value saved to MR0 by a synchronous action.

7.4.6 Multi-Purpose Register 1 Reading

Code	Command	Symbol	Data Range	Data Length (byte)
3 5 h	Multi-purpose register 1 reading	MR 1	-2, 147, 483, 648 ~ +2, 147, 483, 647	4

The value of multi-purpose register MR1 is set to read registers RR6 and RR7.

It can be used to read out the current position, current timer value and current acceleration / deceleration value saved to MR1 by a synchronous action.

7.4.7 Multi-Purpose Register 2 Reading

Code	Command	Symbol	Data Range	Data Length (byte)
3 6 h	Multi-purpose register 2 reading	MR 2	-2, 147, 483, 648 ~ +2, 147, 483, 647	4

The value of multi-purpose register MR2 is set to read registers RR6 and RR7.

It can be used to read out the current position and timer value saved to MR2 by a synchronous action.

7.4.8 Multi-Purpose Register 3 Reading

Code	Command	Symbol	Data Range	Data Length (byte)
3 7 h	Multi-purpose register 3 reading	MR 3	-2, 147, 483, 648 ~ +2, 147, 483, 647	4

The value of multi-purpose register MR3 is set to read registers RR6 and RR7.
It can be used to read out the current position and timer value saved to MR3 by a synchronous action.

7.4.9 Current Timer Value Reading

Code	Command	Symbol	Data Range	Data Length (byte)
3 8 h	Current timer value reading	C T	0 ~ 2, 147, 483, 647	4

The value of current timer value in operation is set to read registers RR6 and RR7. While timer stops, 0 will be read out. The unit of the setting value is μ sec which is the same as Timer value setting (TM)

7.4.10 Interpolation / Finish point maximum value Reading

Code	Command	Symbol	Data Range	Data Length (byte)
3 9 h	Interpolation / Finish point maximum value reading	T X	1~1, 073, 741, 823	4

The maximum value of the finish point of each axis in linear interpolation is set to read registers RR6 and RR7. The axis assignment is not necessary for this command.

The read values differ before and during interpolation driving.

Before interpolation driving, the finish point maximum value at the interpolation segment being inputted will be read. During interpolation driving, the finish point maximum value at the interpolation segment currently being executed will be read.

7.4.11 Current Helical Rotation Number Reading

Code	Command	Symbol	Data Range	Data Length (byte)
3 A h	Current helical rotation number reading	C H L N	0~65, 535	2

The value of current helical rotation number in operation is set to read register RR6. The axis assignment is not necessary for this command.

7.4.12 Helical Calculation Value Reading

Code	Command	Symbol	Data Range	Data Length (byte)
3 Bh	Helical calculation value reading	H L V	1 ~ 2, 147, 483, 646	4

It reads the result of helical calculation by helical calculation command (6Bh, 6Ch). The helical calculation value is set to read registers RR6 and RR7. The axis assignment is not necessary for this command.

For details of helical interpolation, see chapter 3.3.

7.4.13 WR1 Setting Value Reading

Code	Command	Symbol	Data Range	Data Length (byte)
3 Dh	WR1 setting value reading	WR 1	(Bit data)	2

The setting value of WR1 register is set to read register RR6.

WR1 setting value cannot be read by accessing WR1 register address. To check and read out the WR1 setting value, use this command.

Read register RR7 is set as 0.

7.4.14 WR2 Setting Value Reading

Code	Command	Symbol	Data Range	Data Length (byte)
3 Eh	WR2 setting value reading	WR 2	(Bit data)	2

The setting value of WR2 register is set to read register RR6.

WR2 setting value cannot be read by accessing WR2 register address. To check and read out the WR2 setting value, use this command.

Read register RR7 is set as 0.

7.4.15 WR3 Setting Value Reading

Code	Command	Symbol	Data Range	Data Length (byte)
3 Fh	WR3 setting value reading	WR 3	(Bit data)	2

The setting value of WR3 register is set to read register RR6.

WR3 setting value cannot be read by accessing WR3 register address. To check and read out the WR3 setting value, use this command.

Read register RR7 is set as 0.

7.4.16 Multi-Purpose Register Mode Setting Reading

Code	Command	Symbol	Data Range	Data Length (byte)
4 0h	Multi-purpose register mode setting reading	M R M	(Bit data)	2

The value set by multi-purpose register mode setting command (20h) is set to read register RR6.

Read register RR7 is set as 0.

7.4.17 PIO Signal Setting 1 Reading

Code	Command	Symbol	Data Range	Data Length (byte)
4 1h	PIO signal setting 1 reading	P 1 M	(Bit data)	2

The value set by PIO signal setting 1 command (21h) is set to read register RR6.

Read register RR7 is set as 0.

7.4.18 PIO Signal Setting 2 / Other Settings Reading

Code	Command	Symbol	Data Range	Data Length (byte)
4 2h	PIO signal setting 2 / Other settings reading	P 2 M	(Bit data)	2

The value set by PIO signal setting 2 / other settings command (22h) is set to read register RR6.

Read register RR7 is set as 0.

7.4.19 Acceleration Setting Value Reading

Code	Command	Symbol	Data Range	Data Length (byte)
4 3 h	Acceleration setting value reading	A C	1 ~ 536,870,911	4

The value set by acceleration setting command (02h) is set to read registers RR6 and RR7.
The unit of the setting value is pps/sec.

When MR3 value is loaded to acceleration setting value (AC) by a synchronous action, that value will be read out.

7.4.20 Initial Speed Setting Value Reading

Code	Command	Symbol	Data Range	Data Length (byte)
4 4 h	Initial speed setting value reading	S V	1 ~ 8,000,000	4

The value set by initial speed setting command (04h) is set to read registers RR6 and RR7.
The unit of the setting value is pps.

When MR2 value is loaded to initial speed setting value (SV) by a synchronous action that value will be read out.

7.4.21 Drive Speed Setting Value Reading

Code	Command	Symbol	Data Range	Data Length (byte)
4 5 h	Drive speed setting value reading	D V	1 ~ 8,000,000	4

The value set by drive speed setting command (05h) is set to read registers RR6 and RR7.
The unit of the setting value is pps.

When MRm value is loaded to drive speed setting value (DV) by a synchronous action, that value will be read out.

7.4.22 Drive Pulse Number / Finish Point Setting Value Reading

Code	Command	Symbol	Data Range	Data Length (byte)
4 6 h	Drive pulse number / Finish point setting value reading	T P	Drive pulse number/ Absolute position finish point : -2,147,483,646 ~ +2,147,483,646 Interpolation finish point :-1,073,741,823 ~ +1,073,741,823	4

The value set by drive pulse number / finish point setting command (06h) is set to read registers RR6 and RR7.

When MRm value is loaded to drive pulse number / finish point setting value (TP) by a synchronous action, that value will be read out.

7.4.23 Split Pulse Setting 1 Reading

Code	Command	Symbol	Data Range		Data Length (byte)
4 7h	Split pulse setting 1 reading	S P 1	RR6	Split length : 2 ~ 65,535	4
			RR7	Pulse width : 1 ~ 65,534	

The value set by Split pulse setting 1 command (17h) is set to read registers RR6 and RR7.

The split length is set to RR6 and the pulse width is set to RR7.

When MRm value is loaded to split pulse setting 1 (SP1) by a synchronous action, that value will be read out.

7.4.24 General Purpose Input Value Reading

Code	Command	Symbol	Data Range	Data Length (byte)
4 8h	General purpose input value reading	U I	RR7: Lower byte (PIN7~0) RR6: 2 bytes (D15~0 in I2C communication)	4

The axis assignment is not necessary for this command.

In I²C serial interface bus mode, the signal levels of D15~0 (pin number 1~8, 11~18) are set to read register RR6. If not in I²C serial interface bus mode, read register RR6 will be 0.

When PIN7~0 (pin number 132~139) are used as the general purpose input, the signal levels of PIN7~0 are set to the lower 8bits of read register RR7. The upper 8bits are 0.

RR6	D15	D14	D13	D12 ^H	D11	D10	D9	D8	D7	D6	D5	D4 ^L	D3	D2	D1	D0
	D15	D14	D13	D12	D11	D10	D9	D8	D7	D6	D5	D4	D3	D2	D1	D0

RR7	D15	D14	D13	D12 ^H	D11	D10	D9	D8	D7	D6	D5	D4 ^L	D3	D2	D1	D0
	0	0	0	0	0	0	0	0	PIN7	PIN6	PIN5	PIN4	PIN3	PIN2	PIN1	PIN0

When the signal is Low level, 0 is displayed and when the signal is Hi level, 1 is displayed.

7.5 Driving Commands

Driving commands include the commands for drive pulse output for each axis and other related commands. After the command code is written with axis assignment in command register WR0, the command will be executed immediately.

In driving, the n-DRV bit of main status register RR0 becomes 1. When the driving is finished, n-DRV bit will return to 0.

If nINPOS input signal for a servo driver is enabled, the n-DRV bit of main status register RR0 will not return to 0 until nINPOS signal is on its active level after the driving is finished.

[Note]

- It requires 125 nSEC (maximum) to access the command code when CLK = 16MHz. Please write the next command after this period of time.

7.5.1 Relative Position Driving

Code	Command
5 0h	Relative position driving

The signed drive pulse number that is set will be output from the + direction drive pulse signal (nPP) or the – direction drive pulse signal (nPM). When the drive pulse number is positive, it will be output from the output signal nPP, and when it is negative, it will be output from the output signal nPM. (When the pulse output type is independent 2-pulse)

In driving, when one pulse of + direction drive pulses is output, the logical position counter will count up 1, and when one pulse of – direction drive pulses is output, the logical position counter will count down 1.

Before writing the driving command, the user should set the parameters for the outputting speed curve and the drive pulse number appropriately (see the table below).

○ : Required

Parameter	Speed curve to be output				
	Fixed speed	Symmetrical linear acceleration/ deceleration	Non-symmetrical linear acceleration /deceleration	Symmetrical S-curve acceleration /deceleration	Non-symmetrical S-curve acceleration /deceleration
Jerk (JK)				○	○
Deceleration increasing rate (DJ)					○
Acceleration (AC)		○	○	○ *	○ *
Deceleration (DC)			○		○ *
Initial speed (SV)	○	○	○	○	○
Drive speed (DV)	○	○	○	○	○
Drive pulse number / Finish point (TP)	○	○	○	○	○
Manual deceleration point (DP)					○

*Note: Set the maximum value of 536,870,911(1FFF FFFFh). However, in Partial S-curve acceleration / deceleration driving, set the acceleration / deceleration at the linear acceleration / deceleration part.

7.5.2 Counter Relative Position Driving

Code	Command
5 1h	Counter relative position driving

The signed drive pulse number that is set will be output from the + direction drive pulse signal (nPP) or the – direction drive pulse signal (nPM). When the drive pulse number is positive, it will be output from the output signal nPM, and when it is negative, it will be output from the output signal nPP. (When the pulse output type is independent 2-pulse)

This command can be used to output the predetermined drive pulse number in the different direction by driving commands. Usually, set the positive pulses as the drive pulse number (TP). When the user needs to drive in the + direction, write relative position driving command (50h) and when to drive in the – direction, write counter relative position driving command (51h).

In driving, when one pulse of + direction drive pulses is output, the logical position counter will count up 1, and when one pulse of – direction drive pulses is output, the logical position counter will count down 1.

Before writing the driving command, the user should set the parameters for the outputting speed curve and the drive pulse number appropriately.

7.5.3 + Direction Continuous Pulse Driving

Code	Command
5 2h	+ Direction continuous pulse driving

Until the stop command or specified external signal becomes active, pulse numbers will be output through the output signal nPP continuously. (When the pulse output type is independent 2-pulse)

In driving, when one pulse of drive pulses is output, the logical position counter will count up 1.

Before writing the driving command, the user should set the parameters for the outputting speed curve appropriately.

7.5.4 – Direction Continuous Pulse Driving

Code	Command
5 3h	– Direction continuous pulse driving

Until the stop command or specified external signal becomes active, pulse numbers will be output through the output signal nPM continuously. (When the pulse output type is independent 2-pulse)

In driving, when one pulse of drive pulses is output, the logical position counter will count down 1.

Before writing the driving command, the user should set the parameters for the outputting speed curve appropriately.

7.5.5 Absolute Position Driving

Code	Command
5 4 h	Absolute position driving

This command performs the driving from present point to finish point.

Before driving, the destination point based on a home (logical position counter = 0) should be set with a signed 32-bit value by drive pulse number / finish point setting command (06h).

Before writing the driving command, the user should set the parameters for the outputting speed curve and finish point appropriately.

7.5.6 Decelerating Stop

Code	Command
5 6 h	Decelerating stop

This command performs the decelerating stop when the drive pulses are outputting.

If the speed is lower than the initial speed during the driving, the driving will stop instantly.

During interpolation driving, when decelerating stop or instant stop command is written to the main axis, interpolation driving stops.

Once the driving stops, this command will not work.

7.5.7 Instant Stop

Code	Command
5 7 h	Instant stop

This command performs the instant stop when the drive pulses are outputting. Also, the instant stop can be performed in acceleration / deceleration driving.

Once the driving stops, this command will not work.

7.5.8 Direction Signal + Setting

Code	Command
5 8 h	Direction signal + setting

This command is used to set the direction signal DIR to the active level of the + direction before driving when the pulse output type is 1-pulse 1-direction.

As shown in 11.2, once the driving is started in the 1-pulse 1-direction type, the first pulse of drive pulses will be output after 1CLK from when the direction signal is determined. This command can be used to determine the direction signal in the + direction when the user needs to take longer time than time to set up the direction signal for drive pulses.

7.5.9 Direction Signal – Setting

Code	Command
5 9h	Direction signal – setting

This command is used to set the direction signal DIR to the active level of the – direction before driving when the pulse output type is 1-pulse 1-direction.

As shown in 11.2, once the driving is started in the 1-pulse 1-direction type, the first pulse of drive pulses will be output after 1CLK from when the direction signal is determined. This command can be used to determine the direction signal in the – direction when the user needs to take longer time than time to set up the direction signal for drive pulses.

7.5.10 Automatic Home Search Execution

Code	Command
5 Ah	Automatic home search execution

This command executes automatic home search.

Before execution of the command, the automatic home search mode and correct parameters must be set. See chapter 2.5 for details of automatic home search.

7.6 Interpolation Commands

Interpolation commands consist of the commands for 2 / 3 / 4 axes linear interpolation, CW / CCW circular interpolation, 2 / 3 / 4 axes bit pattern interpolation, CW / CCW helical interpolation and other related commands. The axis assignment to D11~8 bits in command register WR0 is not necessary for interpolation commands, set 0 to those bits.

Before the interpolation command is executed, be sure to check the following:

- a. interpolation accessing axes assignment (set by interpolation mode setting)
- b. speed parameter setting for main axis

In interpolation driving, n-DRV bit of interpolating axis in main status register RR0 becomes 1, and will return to 0 when the driving is finished.

[Note]

- It requires 125nSEC (maximum) to access the command code when CLK=16MHz. Please write the next command after this period of time.

7.6.1 1-axis Linear Interpolation Driving (Multichip)

Code	Command
6 0 h	1-axis linear interpolation driving (multichip)

This is available during multichip interpolation. It uses when 1-axis is set for interpolation in main or sub chip.

7.6.2 2-axis Linear Interpolation Driving

Code	Command
6 1 h	2-axis linear interpolation driving

This command performs 2-axis interpolation from present point to finish point.

Before driving, the finish point of the 2 corresponding axes should be set by incremental value.

7.6.3 3-axis Linear Interpolation Driving

Code	Command
6 2 h	3-axis linear interpolation driving

This command performs 3-axis interpolation from present point to finish point.

Before driving, the finish point of the 3 corresponding axes should be set by incremental value.

7.6.4 4-axis Linear Interpolation Driving

Code	Command
6 3 h	4-axis linear interpolation driving

This command performs 4-axis interpolation from present point to finish point.

Before driving, the finish point of the 4 corresponding axes should be set by incremental value.

7.6.5 CW Circular Interpolation Driving

Code	Command
6 4 h	CW circular interpolation driving

This command performs 2-axis clockwise circular interpolation based on center point, from present point to finish point.

Before driving, the finish t and the center point of the 2 corresponding axes should be set by incremental value.

A full circle will come out if the finish position is set as (0, 0).

7.6.6 CCW Circular Interpolation Driving

Code	Command
6 5 h	CCW circular interpolation driving

This command performs 2-axis counterclockwise circular interpolation based on center point, from present point to finish point.

Before driving, the finish and center point of the 2 corresponding axes should be set by incremental value.

A full circle will come out If the finish position is set as (0, 0).

7.6.7 2-Axis Bit Pattern Interpolation Driving

Code	Command
6 6 h	2-axis bit pattern interpolation driving

This command performs 2-axis bit pattern interpolation.

Before driving, the +/- direction bit data of the two interpolating axes should be set, and the setting bit data of each axis (each direction) is at most $16 \times 8 = 128$ -bit. Once the data is over than 128-bit, those remaining data can be filled during the driving.

7.6.8 3-Axis Bit Pattern Interpolation Driving

Code	Command
6 7 h	3-axis bit pattern interpolation driving

This command performs 3-axis bit pattern interpolation.

Before driving, the +/- direction bit data of the three interpolating axes should be set, and the setting bit data of each axis (each direction) is at most $16 \times 8 = 128$ -bit. Once the data is over than 128-bit, those remaining data can be filled during the driving.

7.6.9 4-Axis Bit Pattern Interpolation Driving

Code	Command
6 8 h	4-axis bit pattern interpolation driving

This command performs 4-axis bit pattern interpolation.

Before driving, the +/- direction bit data of the four interpolating axes should be set, and the setting bit data of each axis (each direction) is at most $16 \times 8 = 128$ -bit. Once the data is over than 128-bit, those remaining data can be filled during the driving.

7.6.10 CW Helical Interpolation Driving

Code	Command
6 9 h	CW helical interpolation driving

This command performs helical interpolation in the clockwise direction.

For details of helical interpolation, see chapter 3.3.

7.6.11 CCW Helical Interpolation Driving

Code	Command
6 A h	CCW helical interpolation driving

This command performs helical interpolation in the counterclockwise direction.

7.6.12 CW Helical Calculation

Code	Command
6 Bh	CW helical calculation

This command performs helical calculation in the clockwise direction.

It is required that the total number of output pulses for circular interpolation be found out in advance in order to perform moving of Z or U axis uniformly in helical interpolation. Helical calculation command is to find out this total number of output pulses.

For details of helical interpolation, see chapter 3.3.

7.6.13 CCW Helical Calculation

Code	Command
6 Ch	CCW helical calculation

This command performs helical calculation in the counterclockwise direction.

7.6.14 Deceleration Enabling

Code	Command
6 Dh	Deceleration enabling

This command enables the automatic or manual deceleration in interpolation.

In individual interpolation, the user must write this command before the driving. However, in continuous interpolation, this command should be put in before writing the interpolation command of the interpolation node to be decelerated.

The deceleration is disabled while resetting. When the deceleration enabling command is written, the enabling status is kept until interpolation driving is finished, the deceleration disabling command (6Eh) is written or the reset is performed.

Deceleration enabling / disabling only works during interpolation driving. When driving each axis individually, automatic and manual deceleration is always enabled.

7.6.15 Deceleration Disabling

Code	Command
6 Eh	Deceleration disabling

This command disables the automatic or manual deceleration in interpolation.

7.6.16 Interpolation Interrupt Clear / Single-step Interpolation

Code	Command
6 F h	Interpolation interrupt clear / Single-step interpolation

Interpolation interrupt clear command clears the interrupt (INT1N) generated in continuous interpolation. Single-step interpolation command performs 1-pulse (each step) output in interpolation driving.

For details of interrupt, see chapter 2.10 and for details of single-step interpolation, see chapter 3.9.

7.7 Synchronous Action Operation Commands

Synchronous action operation commands are used to enable, disable or activate a synchronous action.

There are 4 synchronous action sets: SYNC0, 1, 2, 3, and any of synchronous action sets can be enabled, disabled or activated at the same time.

For synchronous action operation commands, set the operation command code to the four D7~D4 bits of WR0 command register and set the synchronous action set which the user wants to operate to the four D3~D0 bits of WR0. That is, when the user wants to enable the synchronous action, set 8h to D7~D4, and when to disable it, set 9h to D7~D4, and when to activate it, set Ah to D7~D4. D3~D0 are corresponding to four synchronous action sets: SYNC3, SYNC2, SYNC1, SYNC0, and set 1 to the bit corresponding to the synchronous action set.

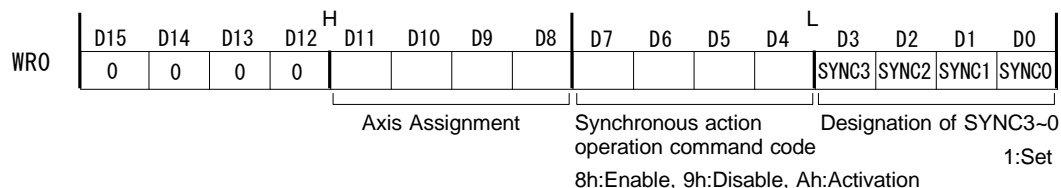

These commands are without writing data and executed by writing the axis assignment and command code into WR0 command register.

[Note]

- It requires 125 nSEC (maximum) to access the command code of synchronous action operation commands when CLK=16MHz. Please write the next command after this period of time.

7.7.1 Synchronous Action Enable Setting

Code	Command
8 1 h ~ 8 F h	Synchronous action enable setting

This command sets to enable each synchronous action set which is specified by the lower 4-bit of the command code.

Before the synchronous action enable setting, the mode setting for the synchronous action set which the user wants to enable must be set by synchronous action SYNC3~0 setting command (29h~26h).

■ Example : To enable the synchronous action sets SYNC0 and SYNC2 in X-axis, write 0185h into WR0.

The enable / disable state of synchronous action SYNC3~0 can be checked by Page 1 of RR3 register.

When resetting, all of SYNC3~0 will be disabled.

[Note]

- By using PIO signal setting 2/other settings command (22h), when the synchronous action activated by an error is disabled by the setting (D7 : ERRDE bit = 1) and when an error occurs (n-ERR bit of RR0 register is 1.), this command cannot be set to enable the synchronous action. Write the synchronous action enable setting command after clearing n-ERR bit by such as error/finishing status clear command (79h).

7.7.2 Synchronous Action Disable Setting

Code	Command
9 1 h ~ 9 F h	Synchronous action disable setting

This command sets to disable each synchronous action set which is specified by the lower 4-bit of the command code. Once the synchronous action is set as disable, it cannot be activated by an activation factor or synchronous action activation command.

■ Example : To disable the synchronous action sets SYNC1 and SYNC3 in X-axis, write 019Ah into WR0.

The enable / disable state of synchronous action SYNC3~0 can be checked by Page 1 of RR3 register. When resetting, all of SYNC3~0 will be disabled.

7.7.3 Synchronous Action Activation

Code	Command
A 1 h ~ A F h	Synchronous action activation

This command sets to activate each synchronous action set which is specified by the lower 4-bit of the command code. Before the synchronous action is activated, the mode setting for the synchronous action set which the user wants to activate must be set by synchronous action SYNC3~0 setting command (29h~26h). And the synchronous action set which the user wants to activate must be enabled by synchronous action enable setting command.

The enable / disable state of synchronous action SYNC3~0 can be checked by Page 1 of RR3 register.

■ Example : To activate the synchronous action set SYNC0 to X-axis, write 01A1h into WR0.
To activate all the synchronous action sets SYNC3~0 to X-axis, write 01AFh into WR0.

7.8 Other Commands

These commands are without writing data and executed by writing the axis assignment and command code into WR0 command register.

[Note]

- It requires 125 nSEC (maximum) to access the command code when CLK=16MHz. Please write the next command after this period of time.

7.8.1 Speed Increase

Code	Command
7 0 h	Speed increase

This command increases a speed by the value of the speed increasing / decreasing value setting during the driving.

The speed increasing/decreasing value (IV) must be set by speed increasing/decreasing value setting command (15h) in advance.

This command can be used during continuous pulse driving. If this command is used frequently during fixed pulse driving, premature termination or creep may occur at the termination of driving.

In S-curve acceleration / deceleration driving, this command will be invalid even if written during acceleration / deceleration. Make sure to use it during constant speed driving (Page1 of RR3 / D5 : CNST=1).

[Note] When changing a drive speed during fixed pulse driving, set the triangle form prevention function to disable (WR3 / D13 : 1).

The drive speed setting value (DV) is not updated by this command.

This command cannot be used in interpolation driving.

7.8.2 Speed Decrease

Code	Command
7 1 h	Speed decrease

This command decreases a speed by the value of the speed increasing / decreasing value setting during the driving.

The speed increasing/decreasing value (IV) must be set by speed increasing/decreasing value setting command (15h) in advance.

This command can be used during continuous pulse driving. If this command is used frequently during fixed pulse driving, premature termination or creep may occur at the termination of driving.

In S-curve acceleration / deceleration driving, this command will be invalid even if written during acceleration / deceleration. Make sure to use it during constant speed driving (Page1 of RR3/ D5 : CNST=1).

[Note] When changing a drive speed during fixed pulse driving, set the triangle form prevention function to disable (WR3 / D13 : 1).

The drive speed setting value (DV) is not updated by this command.

This command cannot be used in interpolation driving.

7.8.3 Deviation Counter Clear Output

Code	Command
7 2 h	Deviation counter clear output

This command outputs deviation counter clear pulses from the nDCC output pin.

Before issuing this command, set the logical level of pulses and pulse width by the automatic home search mode setting 2 command (24h). See chapter 2.5.2 and 2.5.4 for details.

7.8.4 Timer-Start

Code	Command
7 3 h	Timer-start

This command starts a timer.

When a timer is started by this command, the current timer value (CT) starts to count up from 0, and when the count reaches the value specified by the timer value (TM), then the timer is up.

A timer can be used repeatedly after the time is up. To repeat a timer, set D14 bit (TMMD) of WR3 register as 1.

For more details of the timer, see chapter 2.9.

7.8.5 Timer-Stop

Code	Command
7 4 h	Timer-stop

This command stops a timer.

If a timer is stopped before it expires, the current timer value (CT) returns to 0. And if the timer is started again, it counts up from 0.

7.8.6 Start of Split Pulse

Code	Command
7 5 h	Start of split pulse

This command outputs split pulses.

Split pulses are output from the nSPLTP output pin during the driving.

SPLIT bit of Page1 of RR3 register which indicates the split pulse is in operation becomes 1 by issuing start of split pulse command.

Before issuing this command, each parameter such as a split pulse length must be set appropriately.

For more details of each parameter for the split pulse, see chapter 2.7.

7.8.7 Termination of Split Pulse

Code	Command
7 6 h	Termination of split pulse

This command stops to output split pulses.

SPLIT bit of Page1 of RR3 register which indicates the split pulse is in operation becomes 0 by issuing termination of split pulse command.

When termination of split pulse command is written, if the split pulse output signal is on Hi level, it stops after keeping the Hi level of a specified pulse width. (when the positive logic is set.)

7.8.8 Drive Start Holding

Code	Command
7 7 h	Drive start holding

This command is to hold-on the start of driving.

It can be used for starting multi-axis driving simultaneously. Write this command to the axes that the user wants to start simultaneously, and then write the drive command to each axis. Then, if the drive start holding release command (78h) is written, all axes will start the driving simultaneously.

In continuous interpolation driving, this command can be used when interpolation data of necessary segments is set to pre-buffer before the start of driving.

For more details of continuous interpolation, see chapter 3.7.

7.8.9 Drive Start Holding Release

Code	Command
7 8 h	Drive start holding release

This command is to release the drive start holding command (77h), and start the driving.

7.8.10 Error / Finishing Status Clear

Code	Command
7 9 h	Error / Finishing status clear

All the error information bits and the driving finishing status bits of RR2 register and the error bits (D7~4 : n-ERR) of RR0 register are cleared to 0.

This command is used when an error occurs in interpolation driving after checking that interpolation drive stops.

7.8.11 RR3 Page 0 Display

Code	Command
7 Ah	RR3 Page 0 display

This command displays Page0 of RR3 register.
When displaying Page0, D15 bit of RR3 register becomes 0.

7.8.12 RR3 Page 1 Display

Code	Command
7 Bh	RR3 Page 1 display

This command displays Page1 of RR3 register.
When displaying Page1, D15 bit of RR3 register becomes 1.

7.8.13 Maximum finish point clear

Code	Command
7 Ch	Maximum finish point clear

In linear interpolation, this command clears the maximum finish point automatically calculated to the interpolation finish point currently written.
The axis assignment is not necessary for this command.

7.8.14 NOP

Code	Command
1 Fh	N O P

No operation is performed.

7.8.15 Command Reset

Code	Command
0 0 F F h	Command reset

This command resets the IC.

All the upper 8 bits (D15~D8) of WR0 register must be set as 0.

The user cannot access the IC for a period of 8CLK (500nsec : CLK=16MHz) after the command code is written.

Similarly in 8-bit data bus and I2C serial interface bus, this command must write to the high word byte (WR0H).

The user should write 00h into the high word byte (WR0H), and then write FFh into the low word byte (WR0L). Reset will be executed immediately after writing into the low word byte.

8. Connection Examples

8.1 Example of 16-bit Bus Mode Connection

■ Example of Connection with SH-4CPU and 16-bit Bus Mode

Example of 16-bit Bus Mode Connection

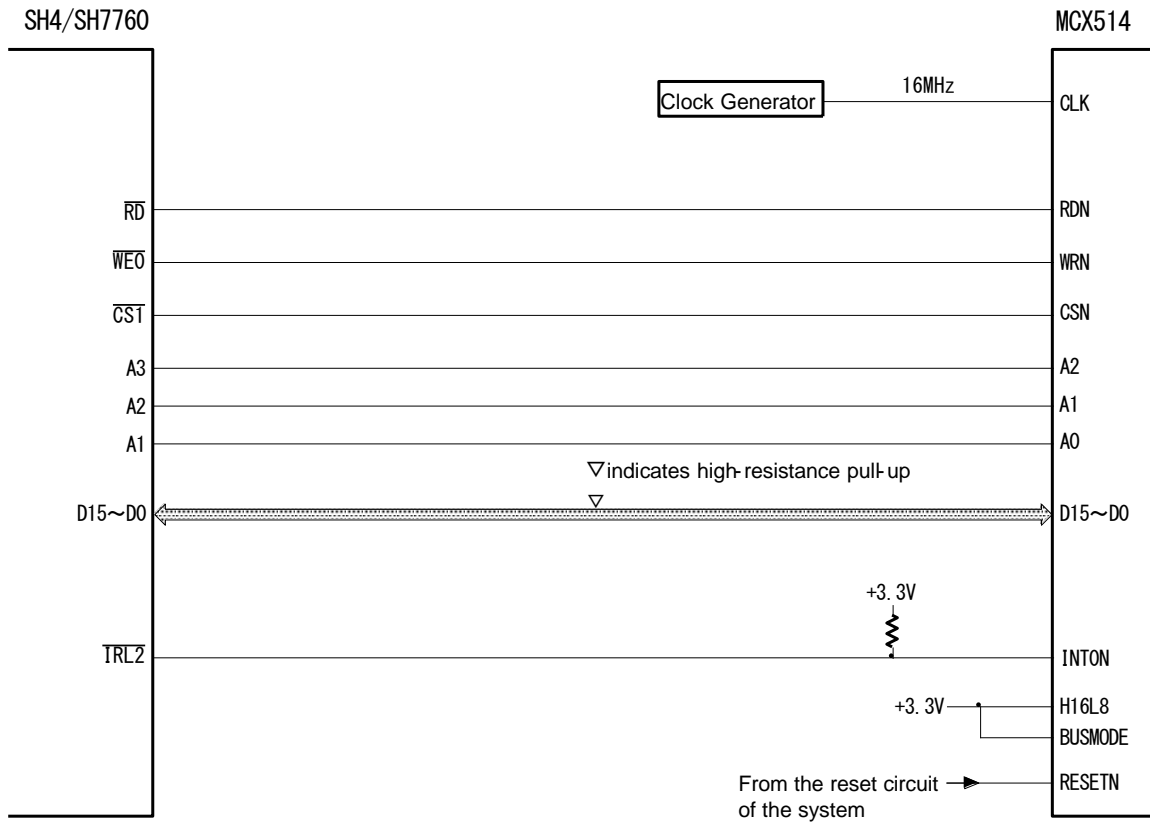

SH-4/SH7760 Examples of Waiting Control

Bus Clock	66.664MHz	—
Setup Waiting	1 cycle insert	Resister set : WCR3/A1S0=1
Access Waiting	2 cycles insert	Resister set : WCR2/A1W2, A1W1, A1W0 = 010
Hold Waiting	1 cycle insert	Resister set : WCR3/A1H1, A1H0 = 01

8.2 Example of Connection in I2C Bus Mode

■ Example of Connection with H8SX1655CPU and I2C Bus Mode

Example of I2C Bus Mode Connection

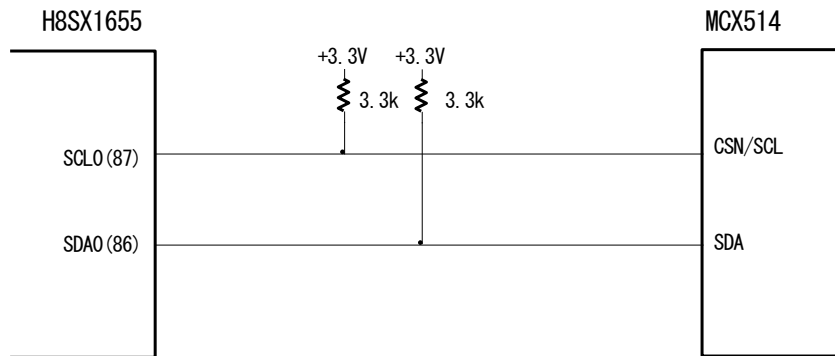

H8SX1655 Examples of Register Setting

Register	Address	Setting value : 8 bit (D7~D0)
ICCRA_0	H'FFEBO	10101001 (*)

(*) D7 : I2C Bus Interface Enable. Setting 1 enables transfer operation.

D5 : selectable from master / slave. Setting to specify master.

D4 : selectable from send / receive. 1 is master receive mode and 0 is master send mode (example is 0).

D3~D0 : select transfer clock. In this case, it is 200kbps (when CLK = 16M).

8.3 Connection Example

The figure below illustrates the connection example of X-axis. All of 4 axes can be configured in the same way as shown below.

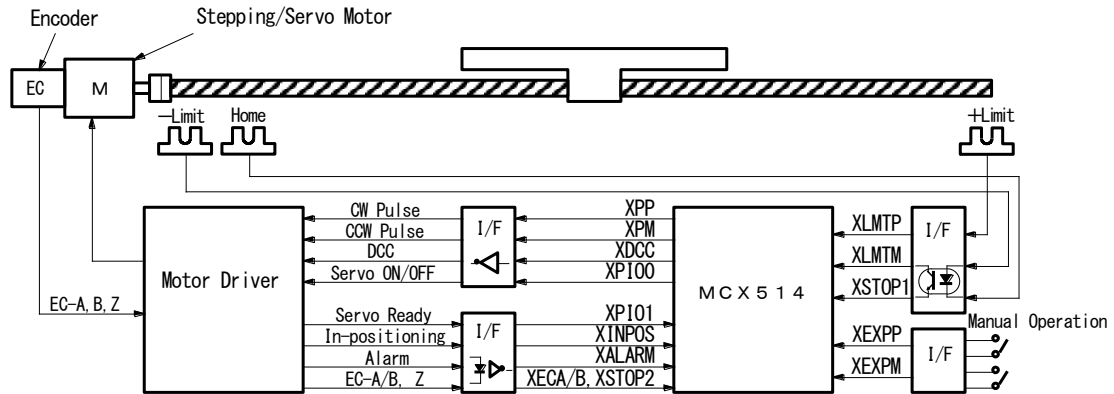

8.4 Pulse Output Interface

■ Output to Motor Driver in Differential Circuit

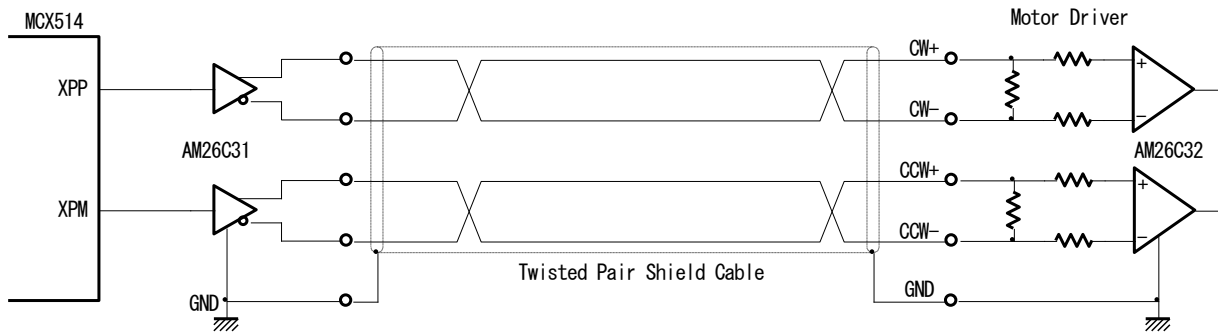

■ Open Collector TTL Output

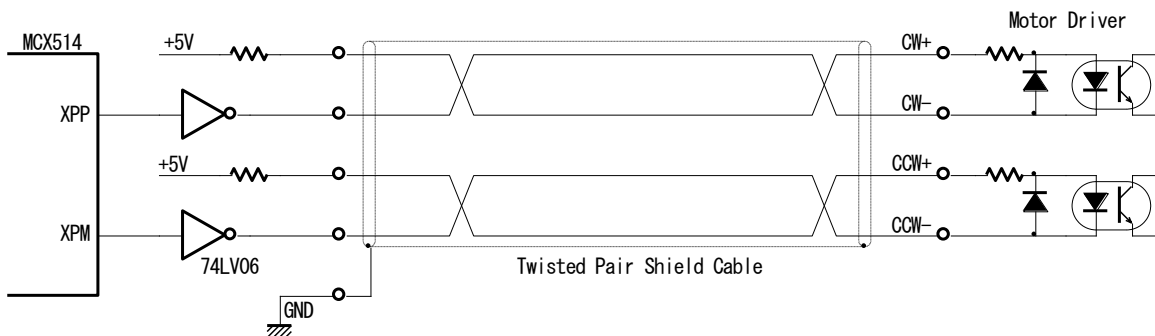

For drive pulse output signals, we recommend the user to use twisted pair shield cable due to the concern of EMC.

8.5 Connection Example for Input Signals

Limit signals often pick up some noise since complicated cabling is normally involved. A photo coupler alone may not be able to absorb this noise. Enable the filter function in the IC and set an appropriate time constant (FL=Ah, Bh).

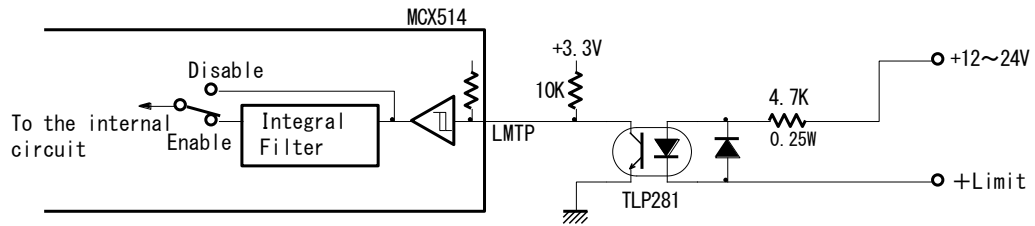

8.6 Connection Example for Encoder

The following diagram is the example for the encoder signal which is differential line-drive output, then, this signal can be received through the high speed photo coupler IC which can direct it to MCX514.

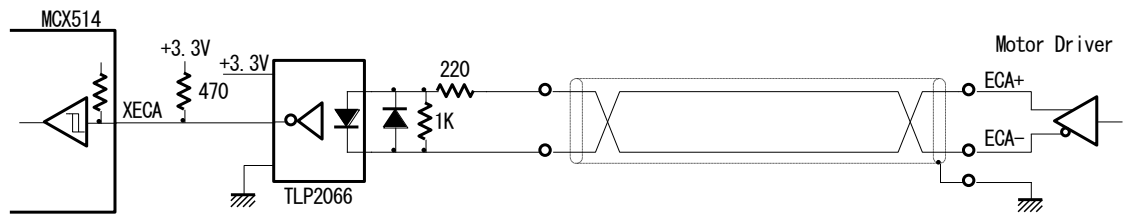

9. Example Program

The example of C program for MCX514 is shown in this chapter. This is a 16-bit bus configuration program. This program can be downloaded from our web site (<http://www.novaelec.co.jp/>). File name : MCX514Aple.c

```
#ifndef NULL
#define NULL ((void *)0)
#endif

/////////////////////////////////////////////////////////////////
// Command code definition
/////////////////////////////////////////////////////////////////
/////////////////////////////////////////////////////////////////
// Commands for writing data
/////////////////////////////////////////////////////////////////
#define MCX514_CMD00_JK 0x0000 // Jerk setting
#define MCX514_CMD01_DJ 0x0001 // Deceleration increasing rate setting
#define MCX514_CMD02_AC 0x0002 // Acceleration setting
#define MCX514_CMD03_DC 0x0003 // Deceleration setting
#define MCX514_CMD04_SV 0x0004 // Initial speed setting
#define MCX514_CMD05_DV 0x0005 // Drive speed setting
#define MCX514_CMD06_TP 0x0006 // Drive pulse number / Finish point setting
#define MCX514_CMD07_DP 0x0007 // Manual deceleration point setting
#define MCX514_CMD08_CP 0x0008 // Circular center point setting
#define MCX514_CMD09_LP 0x0009 // Logical position counter setting
#define MCX514_CMD0A_RP 0x000A // Real position counter setting
#define MCX514_CMD0B_SP 0x000B // Software limit + setting
#define MCX514_CMD0C_SM 0x000C // Software limit - setting
#define MCX514_CMD0D_AO 0x000D // Acceleration counter offsetting
#define MCX514_CMD0E_LX 0x000E // Logical position counter maximum value
setting
#define MCX514_CMD0F_RX 0x000F // Real position counter maximum value setting
#define MCX514_CMD10_MRO 0x0010 // Multi-purpose register 0 setting
#define MCX514_CMD11_MR1 0x0011 // Multi-purpose register 1 setting
#define MCX514_CMD12_MR2 0x0012 // Multi-purpose register 2 setting
#define MCX514_CMD13_MR3 0x0013 // Multi-purpose register 3 setting
#define MCX514_CMD14_HV 0x0014 // Home search speed setting
#define MCX514_CMD15_IV 0x0015 // Speed increasing / decreasing value setting
#define MCX514_CMD16_TM 0x0016 // Timer value setting
#define MCX514_CMD17_SP1 0x0017 // Split pulse setting 1
#define MCX514_CMD18_SP2 0x0018 // Split pulse setting 2
#define MCX514_CMD19_TX 0x0019 // Interpolation / Finish point maximum value
setting
#define MCX514_CMD1A_HLN 0x001A // Helical rotation number setting
#define MCX514_CMD1B_HLV 0x001B // Helical calculation value setting

/////////////////////////////////////////////////////////////////
// Commands for writing mode
/////////////////////////////////////////////////////////////////
#define MCX514_CMD20_MRM 0x0020 // Multi-purpose register mode setting
#define MCX514_CMD21_P1M 0x0021 // PIO signal setting 1
#define MCX514_CMD22_P2M 0x0022 // PIO signal setting 2・Other settings
#define MCX514_CMD23_H1M 0x0023 // Automatic home search mode setting 1
#define MCX514_CMD24_H2M 0x0024 // Automatic home search mode setting 2
#define MCX514_CMD25_FLM 0x0025 // Input signal filter mode setting
#define MCX514_CMD26_SOM 0x0026 // Synchronous action SYNC0 setting
#define MCX514_CMD27_S1M 0x0027 // Synchronous action SYNC1 setting
#define MCX514_CMD28_S2M 0x0028 // Synchronous action SYNC2 setting
#define MCX514_CMD29_S3M 0x0029 // Synchronous action SYNC3 setting
#define MCX514_CMD2A_IPM 0x002A // Interpolation mode setting

/////////////////////////////////////////////////////////////////
// Commands for reading data
/////////////////////////////////////////////////////////////////
#define MCX514_CMD30_LP 0x0030 // Logical position counter reading
#define MCX514_CMD31_RP 0x0031 // Real position counter reading
#define MCX514_CMD32_CV 0x0032 // Current drive speed reading
#define MCX514_CMD33_CA 0x0033 // Current acceleration / deceleration reading
#define MCX514_CMD34_MRO 0x0034 // Multi-purpose register 0 reading
```

```

#define          MCX514_CMD35_MR1          0x0035          // Multi-purpose register 1 reading
#define          MCX514_CMD36_MR2          0x0036          // Multi-purpose register 2 reading
#define          MCX514_CMD37_MR3          0x0037          // Multi-purpose register 3 reading
#define          MCX514_CMD38_CT           0x0038          // Current timer value reading
#define          MCX514_CMD39_TX           0x0039          // Interpolation / Finish point maximum value
reading
#define          MCX514_CMD3A_CHLN         0x003A          // Current helical rotation number reading
#define          MCX514_CMD3B_HLV          0x003B          // Helical calculation value reading
#define          MCX514_CMD3D_WR1          0x003D          // WR1 setting value reading
#define          MCX514_CMD3E_WR2          0x003E          // WR2 setting value reading
#define          MCX514_CMD3F_WR3          0x003F          // WR3 setting value reading
#define          MCX514_CMD40_MRM          0x0040          // Multi-purpose register mode setting reading
#define          MCX514_CMD41_P1M          0x0041          // PIO signal setting 1 reading
#define          MCX514_CMD42_P2M          0x0042          // PIO signal setting 2 · Other settings
reading
#define          MCX514_CMD43_AC           0x0043          // Acceleration setting value reading
#define          MCX514_CMD44_SV           0x0044          // Initial speed setting value reading
#define          MCX514_CMD45_DV           0x0045          // Drive speed setting value reading
#define          MCX514_CMD46_TP           0x0046          // Drive pulse number/Finish point setting
value reading
#define          MCX514_CMD47_SP1          0x0047          // Split pulse setting 1 reading
#define          MCX514_CMD48_UI           0x0048          // General purpose input value reading

////////////////////////////////////
// Driving commands
////////////////////////////////////
#define          MCX514_CMD50_DRVRL        0x0050          // Relative position driving
#define          MCX514_CMD51_DRVNR        0x0051          // Counter relative position driving
#define          MCX514_CMD52_DRVVP        0x0052          // + Direction continuous pulse driving
#define          MCX514_CMD53_DRVVM        0x0053          // - Direction continuous pulse driving
#define          MCX514_CMD54_DRVAB        0x0054          // Absolute position driving
#define          MCX514_CMD56_DRVSBRK      0x0056          // Decelerating stop
#define          MCX514_CMD57_DRVFBRK      0x0057          // Instant stop
#define          MCX514_CMD58_DIRCP        0x0058          // Direction signal + setting
#define          MCX514_CMD59_DIRCM        0x0059          // Direction signal - setting
#define          MCX514_CMD5A_HMSRC        0x005A          // Automatic home search execution

////////////////////////////////////
// Interpolation commands
////////////////////////////////////
#define          MCX514_CMD60_LHK1         0x0060          // 1-axis linear interpolation driving
(multichip)
#define          MCX514_CMD61_LHK2         0x0061          // 2-axis linear interpolation driving
#define          MCX514_CMD62_LHK3         0x0062          // 3-axis linear interpolation driving
#define          MCX514_CMD63_LHK4         0x0063          // 4-axis linear interpolation driving
#define          MCX514_CMD64_CHKCW        0x0064          // CW circular interpolation driving
#define          MCX514_CMD65_CHKCCW       0x0065          // CCW circular interpolation driving
#define          MCX514_CMD66_BHK2         0x0066          // 2-axis bit pattern interpolation driving
#define          MCX514_CMD67_BHK3         0x0067          // 3-axis bit pattern interpolation driving
#define          MCX514_CMD68_BHK4         0x0068          // 4-axis bit pattern interpolation driving
#define          MCX514_CMD69_HLCW         0x0069          // CW helical interpolation driving
#define          MCX514_CMD6A_HLCCW        0x006A          // CCW helical interpolation driving
#define          MCX514_CMD6B_HLPCW        0x006B          // CW helical calculation
#define          MCX514_CMD6C_HLPCCW       0x006C          // CCW helical calculation
#define          MCX514_CMD6D_DECEN        0x006D          // Deceleration enabling
#define          MCX514_CMD6E_DECDIS       0x006E          // Deceleration disabling
#define          MCX514_CMD6F_CLRSTEP       0x006F          // Interpolation interrupt clear / Single-step
interpolation

////////////////////////////////////
// Synchronous action operation commands
////////////////////////////////////
#define          MCX514_CMD81_SYNC0EN      0x0081          // Synchronous action SYNC0 enable setting
#define          MCX514_CMD82_SYNC1EN      0x0082          // Synchronous action SYNC1 enable setting
#define          MCX514_CMD84_SYNC2EN      0x0084          // Synchronous action SYNC2 enable setting
#define          MCX514_CMD88_SYNC3EN      0x0088          // Synchronous action SYNC3 enable setting
#define          MCX514_CMD91_SYNC0DIS     0x0091          // Synchronous action SYNC0 disable setting
#define          MCX514_CMD92_SYNC1DIS     0x0092          // Synchronous action SYNC1 disable setting
#define          MCX514_CMD94_SYNC2DIS     0x0094          // Synchronous action SYNC2 disable setting
#define          MCX514_CMD98_SYNC3DIS     0x0098          // Synchronous action SYNC3 disable setting

```

```

#define          MCX514_CMDA1_SYNC0ACT      0x00A1      // Synchronous action SYNC0 activation
#define          MCX514_CMDA2_SYNC1ACT      0x00A2      // Synchronous action SYNC1 activation
#define          MCX514_CMDA4_SYNC2ACT      0x00A4      // Synchronous action SYNC2 activation
#define          MCX514_CMDA8_SYNC3ACT      0x00A8      // Synchronous action SYNC3 activation

////////////////////////////////////
// Other Commands
////////////////////////////////////
#define          MCX514_CMD70_VINC          0x0070      // Speed increase
#define          MCX514_CMD71_VDEC          0x0071      // Speed decrease
#define          MCX514_CMD72_DCC           0x0072      // Deviation counter clear output
#define          MCX514_CMD73_TMSTA         0x0073      // Timer-start
#define          MCX514_CMD74_TMSTP         0x0074      // Timer-stop
#define          MCX514_CMD75_SPSTA         0x0075      // Split pulse start
#define          MCX514_CMD76_SPSTP         0x0076      // Split pulse stop
#define          MCX514_CMD77_DHOLD         0x0077      // Drive start holding
#define          MCX514_CMD78_DFEE         0x0078      // Drive start holding release
#define          MCX514_CMD79_R2CLR         0x0079      // Error / Finishing status clear
#define          MCX514_CMD7A_RR3P0         0x007A      // RR3 Page0 display
#define          MCX514_CMD7B_RR3P1         0x007B      // RR3 Page1 display
#define          MCX514_CMD1F_NOP           0x001F      // NOP
#define          MCX514_CMDFF_RST          0x00FF      // Command reset

////////////////////////////////////
// Axis definition
////////////////////////////////////
#define          MCX514_AXIS_X              0x01        // X axis
#define          MCX514_AXIS_Y              0x02        // Y axis
#define          MCX514_AXIS_Z              0x04        // Z axis
#define          MCX514_AXIS_U              0x08        // U axis
#define          MCX514_AXIS_ALL            0x0f        // All axes
#define          MCX514_AXIS_NONE           0x00        // No axis

////////////////////////////////////
// Address definition
////////////////////////////////////
#define          REG_ADDR                    0x00000000  // Basic address

// Write register, Read register definition
#define          MCX514_WRO                  0x00
#define          MCX514_WR1                  0x02
#define          MCX514_WR2                  0x04
#define          MCX514_WR3                  0x06
#define          MCX514_WR4                  0x08
#define          MCX514_WR5                  0x0a
#define          MCX514_WR6                  0x0c
#define          MCX514_WR7                  0x0e
#define          MCX514_RRO                  0x00
#define          MCX514_RR1                  0x02
#define          MCX514_RR2                  0x04
#define          MCX514_RR3                  0x06
#define          MCX514_RR4                  0x08
#define          MCX514_RR5                  0x0a
#define          MCX514_RR6                  0x0c
#define          MCX514_RR7                  0x0e

unsigned short reg_read (unsigned short n);

#define          reg_write(n, c)              (*(volatile unsigned short *)n = ((volatile)c))
#define          reg_read(n)                 (*(volatile unsigned short *)n)

////////////////////////////////////
// Common functions definition
////////////////////////////////////
int WriteReg(volatile unsigned short *Adr, unsigned short Data); // Common function of writing WR register
int ReadReg(volatile unsigned short *Adr, unsigned short *Data); // Common function of reading RR register
int SetData(unsigned short Cmd, int Axis, unsigned long Data); // Common function of commands for writing data
int SetModeData(unsigned short Cmd, int Axis, unsigned short Data); // Common function of commands for writing mode
int GetData(unsigned short Cmd, int Axis, unsigned long *Data); // Common function of commands for reading

```

```

data
int ExeCmd(unsigned short Cmd, int Axis); // Common function of command execution

////////////////////////////////////////////////////////////////////////////////////////////////////////////////////////////////
// Write functions for WR register
////////////////////////////////////////////////////////////////////////////////////////////////////////////////////////////////
int WriteReg0(unsigned short Data) { // Writes into WR0 register
    return(WriteReg((volatile unsigned short*)(REG_ADDR + MCX514_WR0), Data));
}
int WriteReg1(int Axis, unsigned short Data) { // Writes into WR1 register
    WriteReg0(((Axis << 8) + MCX514_CMD1F_NOP)); // Axis assignment
    return(WriteReg((volatile unsigned short*)(REG_ADDR + MCX514_WR1), Data));
}
int WriteReg2(int Axis, unsigned short Data) { // Writes into WR2 register
    WriteReg0(((Axis << 8) + MCX514_CMD1F_NOP)); // Axis assignment
    return(WriteReg((volatile unsigned short*)(REG_ADDR + MCX514_WR2), Data));
}
int WriteReg3(int Axis, unsigned short Data) { // Writes into WR3 register
    WriteReg0(((Axis << 8) + MCX514_CMD1F_NOP)); // Axis assignment
    return(WriteReg((volatile unsigned short*)(REG_ADDR + MCX514_WR3), Data));
}
int WriteReg4(unsigned short Data) { // Writes into WR4 register
    return(WriteReg((volatile unsigned short*)(REG_ADDR + MCX514_WR4), Data));
}
int WriteReg5(unsigned short Data) { // Writes into WR5 register
    return(WriteReg((volatile unsigned short*)(REG_ADDR + MCX514_WR5), Data));
}
int WriteReg6(unsigned short Data) { // Writes into WR6 register
    return(WriteReg((volatile unsigned short*)(REG_ADDR + MCX514_WR6), Data));
}
int WriteReg7(unsigned short Data) { // Writes into WR7 register
    return(WriteReg((volatile unsigned short*)(REG_ADDR + MCX514_WR7), Data));
}

////////////////////////////////////////////////////////////////////////////////////////////////////////////////////////////////
// Read functions for RR register
////////////////////////////////////////////////////////////////////////////////////////////////////////////////////////////////
int ReadReg0(unsigned short *Data) { // Reads out RR0 register
    return(ReadReg((volatile unsigned short*)(REG_ADDR + MCX514_RR0), Data));
}
int ReadReg1(int Axis, unsigned short *Data) { // Reads out RR1 register
    WriteReg0(((Axis << 8) + MCX514_CMD1F_NOP)); // Axis assignment
    return(ReadReg((volatile unsigned short*)(REG_ADDR + MCX514_RR1), Data));
}
int ReadReg2(int Axis, unsigned short *Data) { // Reads out RR2 register
    WriteReg0(((Axis << 8) + MCX514_CMD1F_NOP)); // Axis assignment
    return(ReadReg((volatile unsigned short*)(REG_ADDR + MCX514_RR2), Data));
}
int ReadReg3(int Page, int Axis, unsigned short *Data) { // Reads out RR3 register
    if (Page == 0) { // Specifies Page0
        WriteReg0(((unsigned short)(Axis << 8) | MCX514_CMD7A_RR3P0));
    }
    else { // Specifies Page1
        WriteReg0(((unsigned short)(Axis << 8) | MCX514_CMD7B_RR3P1));
    }
    WriteReg0(((unsigned short)(Axis << 8) | MCX514_CMD1F_NOP)); // Axis assignment
    return(ReadReg((volatile unsigned short*)(REG_ADDR + MCX514_RR3), Data));
}
int ReadReg4(unsigned short *Data) { // Reads out RR4 register
    return(ReadReg((volatile unsigned short*)(REG_ADDR + MCX514_RR4), Data));
}
int ReadReg5(unsigned short *Data) { // Reads out RR5 register
    return(ReadReg((volatile unsigned short*)(REG_ADDR + MCX514_RR5), Data));
}
int ReadReg6(unsigned short *Data) { // Reads out RR6 register
    return(ReadReg((volatile unsigned short*)(REG_ADDR + MCX514_RR6), Data));
}
int ReadReg7(unsigned short *Data) { // Reads out RR7 register

```

```

        return(ReadReg((volatile unsigned short*)(REG_ADDR + MCX514_RR7), Data));
    }

// Functions of commands for writing data
// Initial speed setting
int SetStartSpd(int Axis, long Data) {
    return(SetData(MCX514_CMD04_SV, Axis, Data));
}
// Drive speed setting
int SetSpeed(int Axis, long Data) {
    return(SetData(MCX514_CMD05_DV, Axis, Data));
}
// Jerk setting
int SetJerk(int Axis, long Data) {
    return(SetData(MCX514_CMD00_JK, Axis, Data));
}

// Deceleration increasing rate setting
int SetDJerk(int Axis, long Data) {
    return(SetData(MCX514_CMD01_DJ, Axis, Data));
}
// Acceleration setting
int SetAcc(int Axis, long Data) {
    return(SetData(MCX514_CMD02_AC, Axis, Data));
}
// Deceleration setting
int SetDec(int Axis, long Data) {
    return(SetData(MCX514_CMD03_DC, Axis, Data));
}
// Drive pulse number / Finish point setting
int SetPulse(int Axis, long Data) {
    return(SetData(MCX514_CMD06_TP, Axis, Data));
}

// Manual deceleration point setting
int SetDecP(int Axis, long Data) {
    return(SetData(MCX514_CMD07_DP, Axis, Data));
}
// Logical position counter setting
int SetLp(int Axis, long Data) {
    return(SetData(MCX514_CMD09_LP, Axis, (unsigned long)Data));
}
// Real position counter setting
int SetRp(int Axis, long Data) {
    return(SetData(MCX514_CMD0A_RP, Axis, (unsigned long)Data));
}
// Software limit + setting
int SetCompP(int Axis, long Data) {
    return(SetData(MCX514_CMD0B_SP, Axis, (unsigned long)Data));
}
// Software limit - setting
int SetCompM(int Axis, long Data) {
    return(SetData(MCX514_CMD0C_SM, Axis, (unsigned long)Data));
}
// Acceleration counter offsetting
int SetAccOfst(int Axis, long Data) {
    return(SetData(MCX514_CMD0D_AO, Axis, Data));
}
// Home search speed setting
int SetHomeSpd(int Axis, long Data) {
    return(SetData(MCX514_CMD14_HV, Axis, Data));
}
// Logical position counter maximum value setting
int SetLpMax(int Axis, long Data) {
    return(SetData(MCX514_CMD0E_LX, Axis, Data));
}
// Real position counter maximum value setting
int SetRpMax(int Axis, long Data) {
    return(SetData(MCX514_CMD0F_RX, Axis, Data));
}
// Multi-purpose register 0 setting
int SetMRO(int Axis, long Data) {
    return(SetData(MCX514_CMD10_MR0, Axis, Data));
}
// Multi-purpose register 1 setting
int SetMR1(int Axis, long Data) {
    return(SetData(MCX514_CMD11_MR1, Axis, Data));
}
// Multi-purpose register 2 setting
int SetMR2(int Axis, long Data) {
    return(SetData(MCX514_CMD12_MR2, Axis, Data));
}
// Multi-purpose register 3 setting
int SetMR3(int Axis, long Data) {
    return(SetData(MCX514_CMD13_MR3, Axis, Data));
}

```

```

}
int SetSpeedInc(int Axis, long Data) { // Speed increasing / decreasing value setting
    return(SetData(MCX514_CMD15_IV, Axis, Data));
}
int SetTimer(int Axis, long Data) { // Timer value setting
    return(SetData(MCX514_CMD16_TM, Axis, Data));
}
int SetSplit1(int Axis, unsigned short Data1, unsigned short Data2) { // Split pulse setting 1
    unsigned long Data;

    Data = (((unsigned long)Data1 << 16) | (unsigned long)Data2);
    return(SetData(MCX514_CMD17_SP1, Axis, Data));
}
int SetSplit2(int Axis, unsigned long Data) { // Split pulse setting 2
    return(SetData(MCX514_CMD18_SP2, Axis, Data));
}
int SetTPMax(long Data) { // Interpolation / Finish point maximum value
setting
    return(SetData(MCX514_CMD39_TX, MCX514_AXIS_NONE, Data));
}
int SetHLNumber(unsigned short Data) { // Helical rotation number setting
    return(SetData(MCX514_CMD3A_CHLN, MCX514_AXIS_NONE, (long )Data));
}
int SetHLValue(long Data) { // Helical calculation value setting
    return(SetData(MCX514_CMD3B_HLV, MCX514_AXIS_NONE, Data));
}

////////////////////////////////////////////////////////////////////////////////////////////////////////////////////////////////
// Functions of commands for writing mode
////////////////////////////////////////////////////////////////////////////////////////////////////////////////////////////////
int SetModeMRm(int Axis, unsigned short Data) { // Multi-purpose register mode setting
    return(SetModeData (MCX514_CMD20_MRM, Axis, Data));
}
int SetModePI01(int Axis, unsigned short Data) { // PIO signal setting 1
    return(SetModeData (MCX514_CMD21_P1M, Axis, Data));
}
int SetModePI02(int Axis, unsigned short Data) { // PIO signal setting 2 - Other settings
    return(SetModeData (MCX514_CMD22_P2M, Axis, Data));
}
int SetModeHMSrch1(int Axis, unsigned short Data) { // Automatic home search mode setting 1
    return(SetModeData (MCX514_CMD23_H1M, Axis, Data));
}
int SetModeHMSrch2(int Axis, unsigned short Data) { // Automatic home search mode setting 2
    return(SetModeData (MCX514_CMD24_H2M, Axis, Data));
}
int SetModeFilter(int Axis, unsigned short Data) { // Input signal filter mode setting
    return(SetModeData (MCX514_CMD25_FLM, Axis, Data));
}
int SetModeSync0(int Axis, unsigned short Data) { // Synchronous action SYNC0 setting
    return(SetModeData (MCX514_CMD26_S0M, Axis, Data));
}
int SetModeSync1(int Axis, unsigned short Data) { // Synchronous action SYNC1 setting
    return(SetModeData (MCX514_CMD27_S1M, Axis, Data));
}
int SetModeSync2(int Axis, unsigned short Data) { // Synchronous action SYNC2 setting
    return(SetModeData (MCX514_CMD28_S2M, Axis, Data));
}
int SetModeSync3(int Axis, unsigned short Data) { // Synchronous action SYNC3 setting
    return(SetModeData (MCX514_CMD29_S3M, Axis, Data));
}
int SetModeIPM(unsigned short Data) { // Interpolation mode setting
    return(SetModeData (MCX514_CMD2A_IPM, MCX514_AXIS_NONE, Data));
}

////////////////////////////////////////////////////////////////////////////////////////////////////////////////////////////////
// Functions of commands for reading data
////////////////////////////////////////////////////////////////////////////////////////////////////////////////////////////////
int GetLp(int Axis, long *Data) { // Logical position counter reading
    return(GetData (MCX514_CMD30_LP, Axis, (unsigned long*) Data));
}

```

```

int GetRp(int Axis, unsigned long *Data) { // Real position counter reading
    return(GetData(MCX514_CMD31_RP, Axis, (unsigned long*) Data));
}
int GetCV(int Axis, unsigned long *Data) { // Current drive speed reading
    return(GetData(MCX514_CMD32_CV, Axis, Data));
}
int GetCA(int Axis, unsigned long *Data) { // Current acceleration/deceleration reading
    return(GetData(MCX514_CMD33_CA, Axis, Data));
}
int GetCT(int Axis, unsigned long *Data) { // Current timer value reading
    return(GetData(MCX514_CMD38_CT, Axis, Data));
}
int GetMRO(int Axis, unsigned long *Data) { // Multi-purpose register 0 reading
    return(GetData(MCX514_CMD34_MRO, Axis, Data));
}
int GetMR1(int Axis, unsigned long *Data) { // Multi-purpose register 1 reading
    return(GetData(MCX514_CMD35_MR1, Axis, Data));
}
int GetMR2(int Axis, unsigned long *Data) { // Multi-purpose register 2 reading
    return(GetData(MCX514_CMD36_MR2, Axis, Data));
}
int GetMR3(int Axis, unsigned long *Data) { // Multi-purpose register 3 reading
    return(GetData(MCX514_CMD37_MR3, Axis, Data));
}
int GetTX(unsigned long *Data) { // Interpolation/Finish point maximum value
reading
    return(GetData(MCX514_CMD39_TX, MCX514_AXIS_NONE, Data));
}
int GetCHLN(unsigned long *Data) { // Current helical rotation number reading
    return(GetData(MCX514_CMD3A_CHLN, MCX514_AXIS_NONE, Data));
}
int GetHLV(unsigned long *Data) { // Helical calculation value reading
    return(GetData(MCX514_CMD3B_HLV, MCX514_AXIS_NONE, Data));
}
int GetWR1(int Axis, unsigned long *Data) { // WR1 setting value reading
    return(GetData(MCX514_CMD3D_WR1, Axis, Data));
}
int GetWR2(int Axis, unsigned long *Data) { // WR2 setting value reading
    return(GetData(MCX514_CMD3E_WR2, Axis, Data));
}
int GetWR3(int Axis, unsigned long *Data) { // WR3 setting value reading
    return(GetData(MCX514_CMD3F_WR3, Axis, Data));
}
int GetMRM(int Axis, unsigned long *Data) { // Multi-purpose register mode setting reading
    return(GetData(MCX514_CMD40_MRM, Axis, Data));
}
int GetP1M(int Axis, unsigned long *Data) { // P10 signal setting 1 reading
    return(GetData(MCX514_CMD41_P1M, Axis, Data));
}
int GetP2M(int Axis, unsigned long *Data) { // P10 signal setting 2 - Other settings
reading
    return(GetData(MCX514_CMD42_P2M, Axis, Data));
}
int GetAc(int Axis, unsigned long *Data) { // Acceleration setting value reading
    return(GetData(MCX514_CMD43_AC, Axis, Data));
}
int GetStartSpd(int Axis, unsigned long *Data) { // Initial speed setting value reading
    return(GetData(MCX514_CMD44_SV, Axis, Data));
}
int GetSpeed(int Axis, unsigned long *Data) { // Drive speed setting value reading
    return(GetData(MCX514_CMD45_DV, Axis, Data));
}
int GetPulse(int Axis, unsigned long *Data) { // Drive pulse number/Finish point setting
value reading
    return(GetData(MCX514_CMD46_TP, Axis, Data));
}
int GetSplit(int Axis, unsigned long *Data) { // Split pulse setting 1 reading
    return(GetData(MCX514_CMD47_SP1, Axis, Data));
}

```



```

}
int GetUI(unsigned long *Data ){ // General purpose input value reading
    return(GetData(MCX514_CMD48_UI, MCX514_AXIS_NONE, Data));
}

////////////////////////////////////////////////////////////////////////////////////////////////////////////////////////////////
// Driving command functions
////////////////////////////////////////////////////////////////////////////////////////////////////////////////////////////////
int ExeDRVRL(int Axis){ // Relative position driving
    return (ExeCmd(MCX514_CMD50_DRVRL, Axis));
}
int ExeDRVNR(int Axis){ // Counter relative position driving
    return (ExeCmd(MCX514_CMD51_DRVNR, Axis));
}
int ExeDRVVP(int Axis){ // + Direction continuous pulse driving
    return (ExeCmd(MCX514_CMD52_DRVVP, Axis));
}
int ExeDRVVM(int Axis){ // - Direction continuous pulse driving
    return (ExeCmd(MCX514_CMD53_DRVVM, Axis));
}

int ExeDRVAB(int Axis){ // Absolute position driving
    return (ExeCmd(MCX514_CMD54_DRVAB, Axis));
}
int ExeDRVSBRK(int Axis){ // Decelerating stop
    return (ExeCmd(MCX514_CMD56_DRVSBRK, Axis));
}
int ExeDRVFBRK(int Axis){ // Instant stop
    return (ExeCmd(MCX514_CMD57_DRVFBRK, Axis));
}
int ExeDIRCP(int Axis){ // Direction signal + setting
    return (ExeCmd(MCX514_CMD58_DIRCP, Axis));
}
int ExeDIRCM(int Axis){ // Direction signal - setting
    return (ExeCmd(MCX514_CMD59_DIRCM, Axis));
}
int ExeHMSRC(int Axis){ // Automatic home search execution
    return (ExeCmd(MCX514_CMD5A_HMSRC, Axis));
}

////////////////////////////////////////////////////////////////////////////////////////////////////////////////////////////////
// Interpolation command functions
////////////////////////////////////////////////////////////////////////////////////////////////////////////////////////////////
int ExeLHK1(void ){ // 1-axis linear interpolation driving
(multichip)
    return (ExeCmd(MCX514_CMD60_LHK1, MCX514_AXIS_NONE));
}
int ExeLHK2(void ){ // 2-axis linear interpolation driving
    return (ExeCmd(MCX514_CMD61_LHK2, MCX514_AXIS_NONE));
}
int ExeLHK3(void ){ // 3-axis linear interpolation driving
    return (ExeCmd(MCX514_CMD62_LHK3, MCX514_AXIS_NONE));
}
int ExeLHK4(void ){ // 4-axis linear interpolation driving
    return (ExeCmd(MCX514_CMD63_LHK4, MCX514_AXIS_NONE));
}
int ExeCHKCW(void ){ // CW circular interpolation driving
    return (ExeCmd(MCX514_CMD64_CHKCW, MCX514_AXIS_NONE));
}
int ExeCHKCCW(void ){ // CCW circular interpolation driving
    return (ExeCmd(MCX514_CMD65_CHKCCW, MCX514_AXIS_NONE));
}
int ExeBHK2(void ){ // 2-axis bit pattern interpolation driving
    return (ExeCmd(MCX514_CMD66_BHK2, MCX514_AXIS_NONE));
}
int ExeBHK3(void ){ // 3-axis bit pattern interpolation driving
    return (ExeCmd(MCX514_CMD67_BHK3, MCX514_AXIS_NONE));
}
int ExeBHK4(void ){ // 4-axis bit pattern interpolation driving

```

```

        return (ExeCmd(MCX514_CMD68_BHK4, MCX514_AXIS_NONE));
    }
    int ExeHLCW(void ){                                     // CW helical interpolation driving
        return (ExeCmd(MCX514_CMD69_HLCW, MCX514_AXIS_NONE));
    }
    int ExeHLCW(void ){                                     // CCW helical interpolation driving
        return (ExeCmd(MCX514_CMD6A_HLCW, MCX514_AXIS_NONE));
    }
    int ExeHLPW(void ){                                     // CW helical calculation
        return (ExeCmd(MCX514_CMD6B_HLPW, MCX514_AXIS_NONE));
    }
    int ExeHLPCCW(void ){                                   // CCW helical calculation
        return (ExeCmd(MCX514_CMD6C_HLPCCW, MCX514_AXIS_NONE));
    }
    int ExeDECEN(void ){                                    // Deceleration enabling
        return (ExeCmd(MCX514_CMD6D_DECEN, MCX514_AXIS_NONE));
    }
    int ExeDECDS(void ){                                    // Deceleration disabling
        return (ExeCmd(MCX514_CMD6E_DECDS, MCX514_AXIS_NONE));
    }
    int ExeCLRSTEP(void ){                                  // Interpolation interrupt clear / Single-step
        interpolation                                     interpolation
        return (ExeCmd(MCX514_CMD6F_CLRSTEP, MCX514_AXIS_NONE));
    }
    ////////////////////////////////////////////////////////////////////////////////////////////////////////////////////
    // Synchronous action operation command function
    ////////////////////////////////////////////////////////////////////////////////////////////////////////////////////
    int ExeSYNC(int Axis, unsigned short Cmd){            // Command related to synchronous action
        return (ExeCmd(Cmd, Axis));
    }
    ////////////////////////////////////////////////////////////////////////////////////////////////////////////////////
    // Other Commands functions
    ////////////////////////////////////////////////////////////////////////////////////////////////////////////////////
    int ExeVINC(int Axis){                                  // Speed increase
        return (ExeCmd(MCX514_CMD70_VINC, Axis));
    }
    int ExeVDEC(int Axis){                                  // Speed decrease
        return (ExeCmd(MCX514_CMD71_VDEC, Axis));
    }
    int ExeDCC(int Axis){                                    // Deviation counter clear output
        return (ExeCmd(MCX514_CMD72_DCC, Axis));
    }
    int ExeTMSTA(int Axis){                                  // Timer-start
        return (ExeCmd(MCX514_CMD73_TMSTA, Axis));
    }
    int ExeTMSTP(int Axis){                                  // Timer-stop
        return (ExeCmd(MCX514_CMD74_TMSTP, Axis));
    }
    int ExeSPSTA(int Axis){                                  // Split pulse start
        return (ExeCmd(MCX514_CMD75_SPSTA, Axis));
    }
    int ExeSPSTP(int Axis){                                  // Split pulse stop
        return (ExeCmd(MCX514_CMD76_SPSTP, Axis));
    }
    int ExeDHOLD(int Axis){                                  // Drive start holding
        return (ExeCmd(MCX514_CMD77_DHOLD, Axis));
    }
    int ExeDFREE (int Axis){                                  // Drive start holding release
        return (ExeCmd(MCX514_CMD78_DFEE, Axis));
    }
    int ExeR2CLR(int Axis){                                  // Error / Finishing status clear
        return (ExeCmd(MCX514_CMD79_R2CLR, Axis));
    }
    int ExeRR3P0(int Axis){                                  // RR3 Page0 display
        return (ExeCmd(MCX514_CMD7A_RR3P0, Axis));
    }
    int ExeRR3P1(int Axis){                                  // RR3 Page1 display
        return (ExeCmd(MCX514_CMD7B_RR3P1, Axis));
    }

```

```

}
int ExeNOP(int Axis){                                     // NOP
    return (ExeCmd(MCX514_CMD1F_NOP, Axis));
}
int ExeSRST(void ){                                     // Command reset
    return (ExeCmd(MCX514_CMDFF_RST, MCX514_AXIS_NONE));
}

////////////////////////////////////////////////////////////////////////////////////////////////////////////////////////////////
// Common functions
////////////////////////////////////////////////////////////////////////////////////////////////////////////////////////////////
// Common function of writing WR register (I/O port access. The following is the example of SH microcomputer.)
int WriteReg(volatile unsigned short *Adr, unsigned short Data) {
    reg_write(Adr, Data);
    return 0;
}
// Common function of reading RR register (I/O port access. The following is the example of SH microcomputer.)
int ReadReg(volatile unsigned short *Adr, unsigned short *Data) {
    *Data = reg_read(Adr);
    return 0;
}

```

```

// Common function of commands for writing data
// Data can be written by writing data into WR6, WR7, and then writing a command into WRO.
int SetData(unsigned short Cmd, int Axis, unsigned long Data) {

    unsigned long mask_data = 0x0000ffff;
    unsigned short write_data;

    // Writes the lower 16-bit of data into WR6
    write_data = (unsigned short)(Data & mask_data);
    WriteReg6(write_data);

    // Writes the upper 16-bit of data into WR7
    write_data = (unsigned short)(Data >> 16);
    WriteReg7(write_data);

    // Writes a command (into WRO)
    WriteReg0(((unsigned short)(Axis << 8) | Cmd));

    return 0;
}

// Common function of commands for writing mode
// Data can be written by writing data into WR6, and then writing a command into WRO.
int SetModeData(unsigned short Cmd, int Axis, unsigned short Data) {

    // Writes the lower 16-bit of data into WR6
    WriteReg6(Data);

    // Writes a command (into WRO)
    WriteReg0(((unsigned short)(Axis << 8) | Cmd));

    return 0;
}

// Common function of commands for reading data
// Data can be read by writing a command into WRO, and then read RR6, RR7.
int GetData(unsigned short Cmd, int Axis, unsigned long *Data) {

    unsigned short rdata1, rdata2;
    unsigned long retdata = 0x00000000;

    if (Data == NULL) return 0;

    // Writes a command (into WRO)
    WriteReg0(((unsigned short)(Axis << 8) | Cmd));

    // Reads RR7
    ReadReg7(&rdata1);

    // Reads RR6
    ReadReg6(&rdata2);

    // Create data for reading
    retdata = (unsigned long)rdata1; // Sets RR7 value to the upper 16-bit
    *Data = (retdata << 16);
    retdata = (unsigned long)rdata2; // Sets RR6 value to the lower 16-bit
    *Data = *Data | retdata;

    return 0;
}

// Common function of command execution
int ExeCmd(unsigned short Cmd, int Axis) {

    // Writes a command (into WRO)
    WriteReg0(((unsigned short)(Axis << 8) | Cmd));

    return 0;
}

```

```

// Waiting for termination of driving
void waitdrive(int Axis) {

    unsigned short rrData;

    ReadReg0(&rrData);           // Reads RR0
    while ((rrData & Axis) {     // If during the driving
        ReadReg0(&rrData);       // Reads RR0
    }
}

// Waiting for termination of split pulse
void waitsplit(int Axis) {

    unsigned short rrData;

    ReadReg3(1, Axis, &rrData); // Reads RR3 Page1
    while ((rrData & 0x0800) {   // If split pulse is in operation
        ReadReg3(1, Axis, &rrData); // Reads RR3 Page1
    }
}

////////////////////////////////////////////////////////////////////////////////////////////////////////////////////////////////
// Operation example functions
////////////////////////////////////////////////////////////////////////////////////////////////////////////////////////////////
// Automatic home search
// Performs Automatic Home search using a home signal.
void homesrch(void) {

    WriteReg2(MCX514_AXIS_X, 0x0800); // Home signal logical setting STOP1 Low active
                                        // Enables hardware limit
    SetModeFilter(MCX514_AXIS_X, 0x0A0F); // STOP1 Enables the filter
                                        // Filter delay 512µsec
    SetModeHMSrch1(MCX514_AXIS_X, 0x8037); // Step 4 Execution
                                        // Step 3 Non-execution
                                        // Step 2 Execution
                                        //          Detection signal STOP1
                                        //          Search direction -direction
                                        //          LP,RP clear Disable
                                        //          DCC clear Disable
                                        // Step 1 Execution
                                        //          Detection signal STOP1
                                        //          Search direction -direction
    SetModeHMSrch2(MCX514_AXIS_X, 0x0000); // Timer between steps Disable
                                        // At the termination of home search, LP, RP clear Disable
    SetAcc(MCX514_AXIS_X, 95000); // Acceleration 95000 pps/sec
    SetStartSpd(MCX514_AXIS_X, 1000); // Initial speed 1000pps
    SetSpeed(MCX514_AXIS_X, 20000); // Speed of step 1 and 4 20000pps
    SetHomeSpd(MCX514_AXIS_X, 500); // Speed of step 2 500pps
    SetPulse(MCX514_AXIS_X, 3500); // Offset driving pulse count 3500
    ExeHMSRC(MCX514_AXIS_X); // Automatic home search execution
    waitdrive(MCX514_AXIS_X); // Waiting for termination of driving
}

// All axes S-curve acceleration/deceleration driving
// Perform S-curve acceleration from initial speed 10pps to drive speed 2Kpps in 0.4 seconds
void drive(void) {

    SetStartSpd(MCX514_AXIS_ALL, 10); // Initial speed 10pps
    SetSpeed(MCX514_AXIS_ALL, 2000); // Drive speed 2Kpps
    SetAcc(MCX514_AXIS_ALL, 536870911); // Acceleration (maximum in specification)
    SetJerk(MCX514_AXIS_ALL, 49750); // Jerk 49750pps/sec2
    SetPulse(MCX514_AXIS_ALL, 70000); // Drive pulse number 70000
    SetLp(MCX514_AXIS_ALL, 0); // Logical position counter Clear
    WriteReg3(MCX514_AXIS_ALL, 0x0004); // Specifies S-curve acceleration/deceleration driving
    ExeDRVRL(MCX514_AXIS_ALL); // Relative position driving
    waitdrive(MCX514_AXIS_ALL); // Waiting for termination of driving
}

```

```

// Synchronous action
// Performs to calculate the time passing through from position A to position B during X axis driving.
void sync(void ) {
    unsigned long      Data;

    SetStartSpd(MCX514_AXIS_X, 8000000); // Initial speed 8Mpps (maximum in specification)
    SetSpeed(MCX514_AXIS_X, 1000); // Drive speed 1Kpps (constant speed driving)
    SetLp(MCX514_AXIS_X, 0); // Logical position counter 0
    SetPulse(MCX514_AXIS_X, 60000); // Drive pulse number 60000
    SetMR0(MCX514_AXIS_X, 10000); // MR0 10000
    SetMR1(MCX514_AXIS_X, 55000); // MR1 55000
    SetTimer(MCX514_AXIS_X, 2147483647); // Timer value (maximum in specification)
    WriteReg1(MCX514_AXIS_X, 0x2000); // WR1 Synchronous action set 1 activation
    SetModeMRm(MCX514_AXIS_X, 0x0000); // Multi-purpose register mode setting
    // Compares MR0 with LP. Comparison condition  $\geq$ 
    // Compares MR1 with LP. Comparison condition  $\geq$ 

    SetModeSync0(MCX514_AXIS_X, 0x0151); // SYNC0 setting
    // Activation factor MRm object changed to True
    // Action Timer-start

    SetModeSync1(MCX514_AXIS_X, 0x0071); // SYNC1 setting
    // Activation factor MRm object changed to True
    // Action Save CT→MRm

    ExeSYNC(MCX514_AXIS_X, (MCX514_CMD81_SYNCOEN | MCX514_CMD82_SYNC1EN));
    // SYNC0,1 Enable

    ExeDRVRL(MCX514_AXIS_X); // Relative position driving
    waitdrive(MCX514_AXIS_X); // Waiting for termination of driving
    GetMR1(MCX514_AXIS_X, &Data); // Multi-purpose register 1 reading
}

// Split pulse
// Performs to start Split pulse from the start of X axis driving.
void split(void ) {

    SetStartSpd(MCX514_AXIS_X, 8000000); // Initial speed 8Mpps (maximum in specification)
    SetSpeed(MCX514_AXIS_X, 100); // Drive speed 100pps
    SetLp(MCX514_AXIS_X, 0); // Logical position counter
    SetSplit1(MCX514_AXIS_X, 5, 9); // Split length 9 Pulse width 5
    SetSplit2(MCX514_AXIS_X, 20); // Pulse number 20
    SetModePIO2(MCX514_AXIS_X, 0x0800); // Pulse logic Positive, With starting pulse
    ExeSPSTA(MCX514_AXIS_X); // Split pulse start
    ExeDRVVP(MCX514_AXIS_X); // +direction continuous pulse driving
    waitsplit(MCX514_AXIS_X); // Waiting for termination of split pulse
    ExeDRVFBRK(MCX514_AXIS_X); // Instant stop
    waitdrive(MCX514_AXIS_X); // Waiting for termination of driving
}

// Main functions
void main(void ) {

    ExeSRST(); // Command reset

    homesrch(); // Automatic home search

    drive(); // S-curve acceleration / deceleration driving

    sync(); // Synchronous action

    split(); // Split pulse
}

```

10. Electrical Characteristics

10.1 DC Characteristics

■ Absolute Maximum Ratings

Item	Symbol	Condition	Value	Unit
Power Voltage	V_{DD}	—	-0.3 ~ +4.0	V
Input voltage	V_I	$V_I < V_{DD} + 3.0V$	-0.3 ~ +7.0	V
Output voltage	V_O	$V_O < V_{DD} + 3.0V$	-0.3 ~ +7.0	V
Output Current	I_O	—	±30	mA
Preservation Temperature	T_{STG}		-65 ~ +150	°C

■ Recommend Operation Environment

Item	Symbol	Value	Unit
Power Voltage	V_{DD}	3.3 ± 0.3	V
Operating temperature	T_{OPR}	-40 ~ +85	°C

■ DC Characteristics

($T_{OPR} = -40 \sim +85^{\circ}C$, $V_{DD} = 3.3V \pm 0.3V$)

Item	Symbol	Condition	Min.	Typ.	Max.	Unit	Remark
High level input voltage	V_{IH}		2.0		5.5	V	
Low level input voltage	V_{IL}		-0.3		0.8	V	
High level input current	I_{IH}	$V_{IN} = V_{DD}$			1.0	μA	
Low level input current	I_{IL}	$V_{IN} = 0V$			-1.0	μA	
High level output voltage	V_{OH}	$I_{OH} = 0mA$	$V_{DD} - 0.2$			V	Note1
		$I_{OH} = -12mA$	$V_{DD} - 0.4$			V	D15~D0 signal
		$I_{OH} = -6mA$	$V_{DD} - 0.4$			V	Other signals except those above
Low level output voltage	V_{OL}	$I_{OL} = 0mA$			0.1	V	
		$I_{OL} = 12mA$			0.4	V	D15~D0 signal INT0N,INT1N signal
		$I_{OL} = 6mA$			0.4	V	Other signals except those above
Output leakage current	I_{OZ}	$V_{OUT} = V_{DD}$ or GND	-1		1	μA	D15~D0 signal PIN6, PIN5 signal INT0N, INT1N signal SDA signal
Schmitt hysteresis voltage	V_H		0.1			V	
Consumption current	I_{DD}	$I_{IO} = 0mA$, CLK=16MHz		150	204	mA	
		$I_{IO} = 0mA$, CLK=20MHz		190	252		

Note1: INT0N, INT1N output signals and PIN6, PIN5, SDA signals have no items for high level output voltage due to the open drain output.

■ Pin Capacity

Item	Symbol	Condition	Min.	Typ.	Max.	Unit	Remark
Input/ Output capacity	C_{IO}	$T_{OPR} = 25^{\circ}C$, $f = 1MHz$			10	pF	D15~D0 signal nPIO7~nPIO0 signal PIN7~PIN0 signal SDA signal
Input capacity	C_I				10		

10.2 AC Characteristics

($T_{OPR} = -40 \sim +85^{\circ}C$, $V_{DD} = +3.3V \pm 10\%$, Output load condition: D15~D0, INTN:85pF, SDA:400pF, Others:50pF)

10.2.1 Clock

■ CLK Input Signal

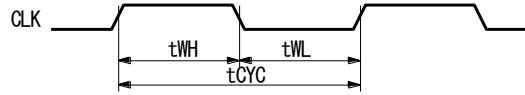

Symbol	Item	Min.	Typ.	Max.	Unit
t_{CYC}	CLK Cycle	50	62.5		nS
t_{WH}	CLK Hi Level Width	15			nS
t_{WL}	CLK Low Level Width	15			nS

10.2.2 Read / Write Cycle

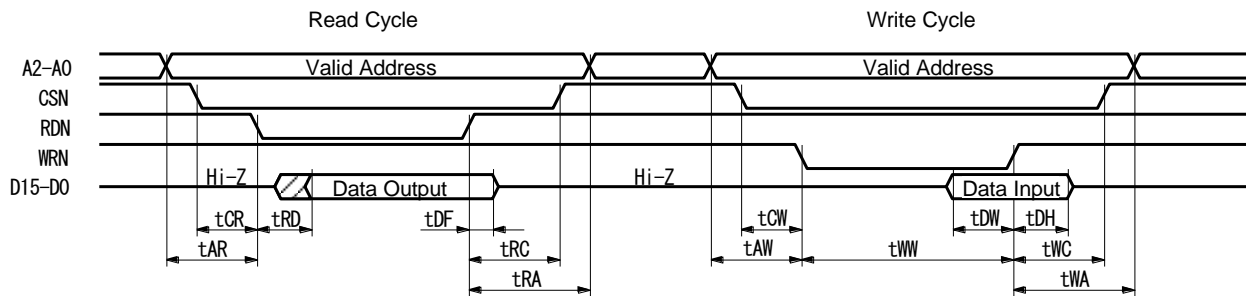

The figure shown above is used for 16-bit data bus accessing (H16L8 = Hi). For 8-bit data bus (H16L8 = Low), the address signals shown in the figure become A3~A0, and data signals become D7~D0.

Symbol	Item	Min.	Max.	Unit
t_{AR}	Address Setup Time (to RDN ↓)	0		nS
t_{CR}	CSN Setup Time (to RDN ↓)	0		nS
t_{RD}	Output Data Delay Time (from RDN ↓)		21	nS
t_{DF}	Output Data Hold Time (from RDN ↑)	0	12	nS
t_{RC}	CSN Hold Time (from RDN ↑)	0		nS
t_{RA}	Address Hold Time (from RDN ↑)	3		nS
t_{AW}	Address Setup Time (to WRN ↓)	0		nS
t_{CW}	CSN Setup Time (to WRN ↓)	0		nS
t_{WW}	WRN Low Level Pulse Width	30		nS
t_{DW}	Setup Time of Input Data (to WRN ↑)	10		nS
t_{DH}	Hold Time of Input Data (from WRN ↑)	0		nS
t_{WC}	CSN Hold Time (from WRN ↑)	0		nS
t_{WA}	Address Hold Time (from WRN ↑)	4		nS

10.2.3 CLK / Output Signal Timing

The following output signals are synchronized with CLK signal. The level will be changed at CLK ↑ .

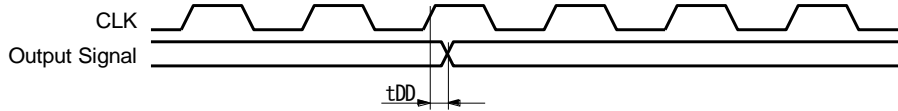

Output signals: nPP, nPM, nDCC, nSPLTP, nPIO7~0 (according to the function selected)

Symbol	Item	Min.	Max.	Unit
tDD	CLK ↑ → Output Signal ↑ ↓ Delay Time	7	30	nS

Output signals: INT0N, INT1N

Symbol	Item	Min.	Max.	Unit
tDD	CLK ↑ → INT0N, INT1N Signal ↓ Delay Time	12	22	nS

10.2.4 Input Pulses

■ Quadrature Pulses Input Mode (A/B phases)

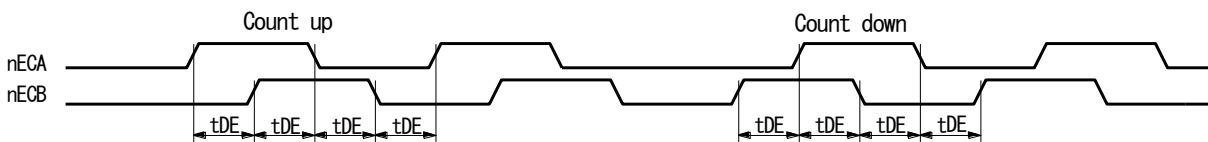

■ Up / Down Pulses Input Mode

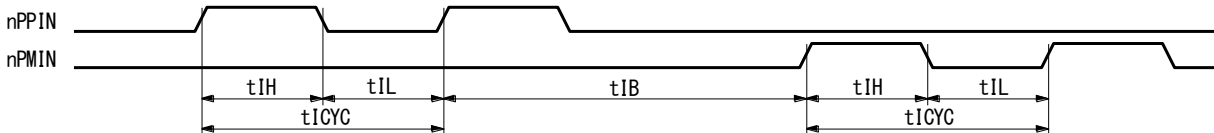

- a. In quadrature pulses input mode, when nECA, nECB input pulses are changed, the value of real position counter will be reflected in the value of after a maximum of 4 CLK cycles.
- b. In UP/DOWN pulses input mode, the value of real position counter will be reflected in the value of after a maximum of 4 CLK cycles from nPPIN, nPMIN input ↑ .

Symbol	Item	Min.	Max.	Unit
tDE	nECA, nECB Phase Difference Time	tCYC +20		nS
tIH	nPPIN, nPMIN Hi Level Width	tCYC +20		nS
tIL	nPPIN, nPMIN Low Level Width	tCYC +20		nS
tICYC	nPPIN, nPMIN Cycle	tCYC × 2 +20		nS
tIB	nPPIN ↑ ↔ nPMIN ↑ between Time	tCYC × 2 +20		nS

tCYC is a cycle of CLK.

10.2.5 General Purpose Input / Output Signals (nPIO7~0)

The figure shown at the lower left hand side illustrates the delay time when nPIO7~0 input signals are read through RR4, 5 registers. The IC built-in filter is disabled.

The figure shown at the lower right hand side illustrates the delay time when writing nPIO7~0 output signals data into WR4, 5 registers.

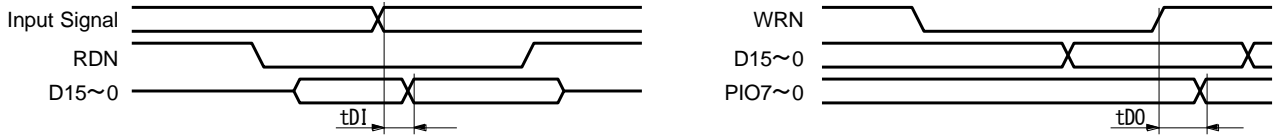

Symbol	Item	Min.	Max.	Unit
tDI	Input Signal → Data Delay Time		17	nS
tDO	WRN ↑ → Data Setup Time		23	nS

10.2.6 Split Pulse

The delay time from the rising edge of the drive pulse that starts the split pulse to when the split pulse becomes Hi (Split pulse is positive logic).

When with starting pulse, only the first split pulse is output together with the drive pulse. The second or later split pulses are output with 1 CLK delay from the drive pulse.

When without starting pulse, all the split pulses are output with 1 CLK delay from the drive pulse.

■ When with starting pulse is enabled in split pulse mode setting

This is, when with starting pulse is enabled in split pulse mode setting, the delay time from the rising edge of the drive pulse that starts the split pulse to when the split pulse becomes Hi.

tDS1 is the delay time of the first split pulse. tDS2 indicates the delay time of the second or later split pulses. The second or later split pulses are output with 1 CLK delay.

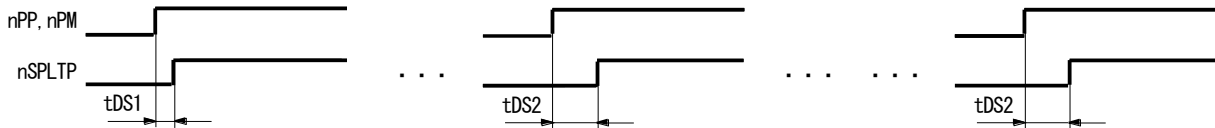

Symbol	Item	Min.	Max.	Unit
tDS1	nPP, nPM ↑ → nSPLTP ↑ Delay Time		20	nS
tDS2	nPP, nPM ↑ → nSPLTP ↑ Delay Time		tCYC +20	nS

tCYC is a cycle of CLK.

■ When without starting pulse is enabled in split pulse mode setting

This is, when without starting pulse is enabled in split pulse mode setting, the delay time from the rising edge of the drive pulse that starts the split pulse to when the split pulse becomes Hi.

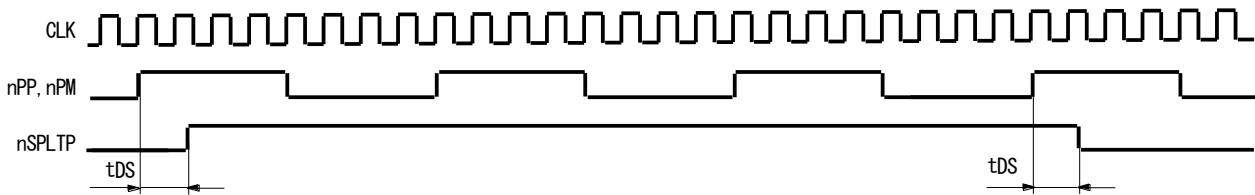

Symbol	Item	Min.	Max.	Unit
tDS	nPP, nPM ↑ → nSPLTP ↑ Delay Time		tCYC +20	nS

tCYC is a cycle of CLK.

10.2.7 I²C Serial Bus (At fast mode.)

■ SCL Clock

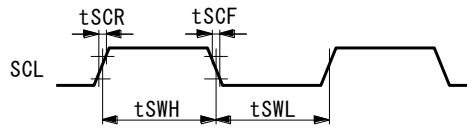

Symbol	Item	Min.	Max.	Unit
fSCL	SCL Clock Frequency		400	KHz
tSWH	SCL Clock Hi Level Width	600		nS
tSWL	SCL Clock Low Level Width	1300		nS
tSCR	SCL Clock Time of rising edge		300	nS
tSCF	SCL Clock Time of falling edge		300	nS

■ Start / Stop Condition

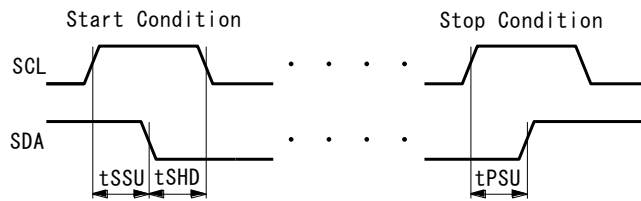

Symbol	Item	Min.	Max.	Unit
tSSU	Start Condition Setup Time	600		nS
tSHD	Start Condition Hold Time	600		nS
tPSU	Stop Condition Setup Time	600		nS

■ Writing / Reading SDA Data

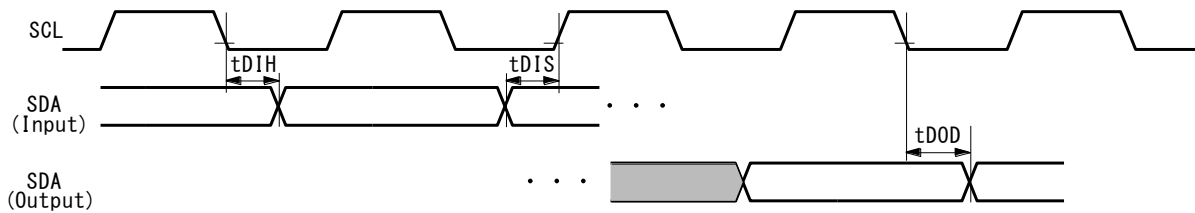

Symbol	Item	Min.	Max.	Unit
tDIH	SDA Input Hold Time	0		nS
tDIS	SDA Input Setup Time	100		nS
tDOD	SDA Output Delay Time	0	900	nS

11. Timing of Input / Output Signals

11.1 Power-On Reset

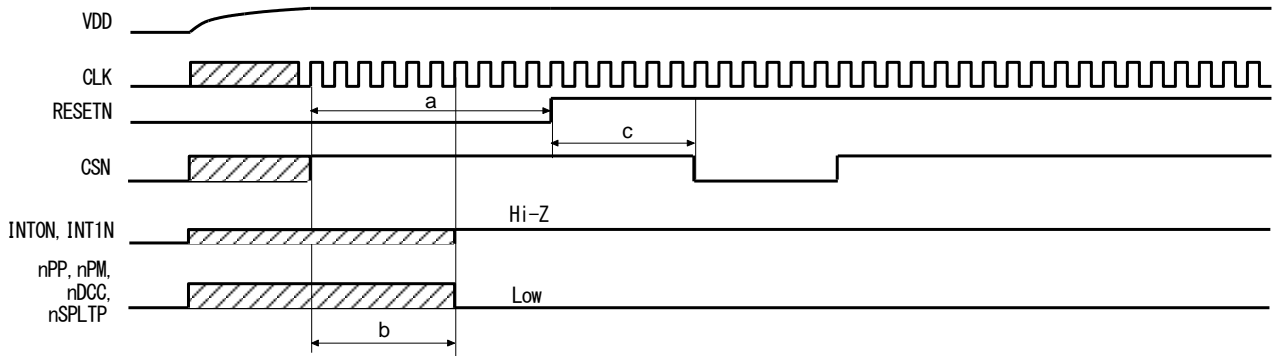

- a. The reset signal input to pin RESETN needs to keep on the Low level for at least 8 CLK cycles.
- b. When RESETN is on the Low level for 6 CLK cycles maximum, the power-on output signal is determined to the level shown in the figure above.
- c. For a maximum of 4 CLK cycles after RESETN is on the Hi level, this IC cannot be read/written.

11.2 Timing of drive start / finish

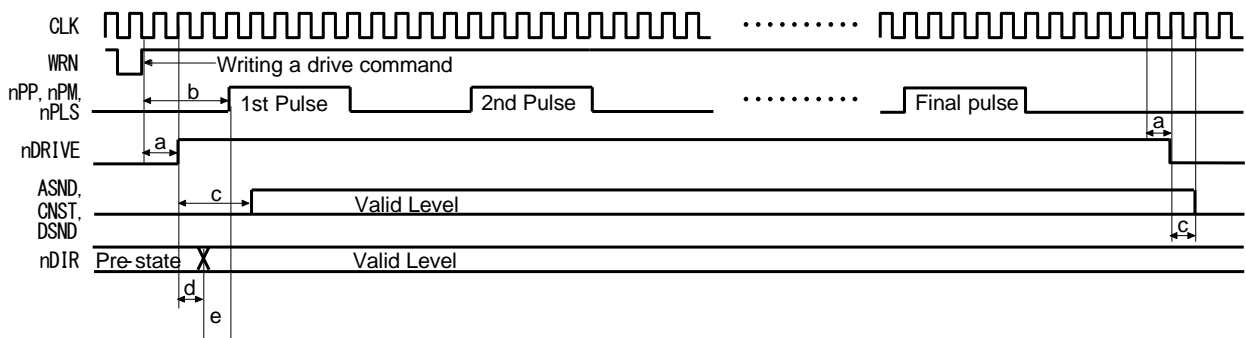

- a. Drive status output signal (nDRIVE) is on Hi level after a maximum of 2 CLK cycles from WRN ↑ when a driving command is written. And it returns to Low level after 1 CLK cycle from when the cycle of final pulse output has finished.
- b. Driving pulses (nPP, nPM and nPLS) shown above are positive logic pulses. The first driving pulse will be output after a maximum of 4 CLK cycles from WRN ↑ when a driving command is written.
- c. ASND, CNST and DSND are on valid level after 3 CLK cycles from nDRIVE ↑ and they return to Low level after 1 CLK cycle from nDRIVE ↓ .
- d. When in 1-pulse 1-direction type, nDIR (direction) signal is valid after 1 CLK cycle from nDRIVE ↑ and keeps its level until the next command is written after the driving is finished.
- e. The first pulse of the drive pulse (nPLS) will be output after 1 CLK cycle from when nDIR (direction) signal is valid.

11.3 Interpolation Driving

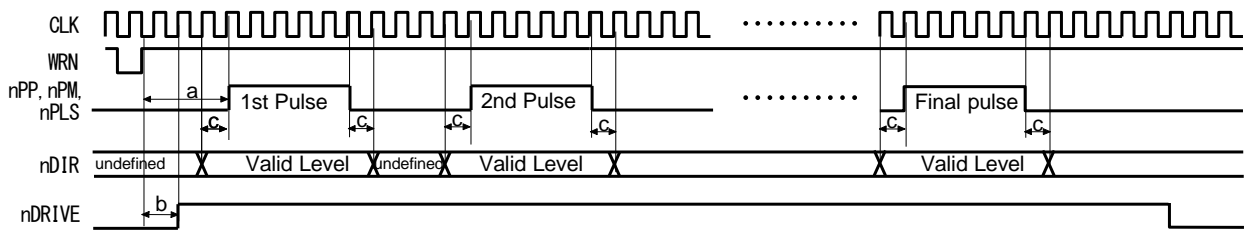

- a. The first pulses (nPP, nPM and nPLS) during interpolation driving will be output after a maximum of 4 CLK cycles from WRN ↑ when a driving command is written.
- b. nDRIVE will become Hi level after a maximum of 2 CLK cycles from WRN ↑ .
- c. When in 1-pulse 1-direction type, nDIR (direction) signal is on valid level while Hi level pulse is being output and the period of 1CLK cycle before and after the output (when drive pulse is positive logic).

11.4 Start Driving after Hold Command

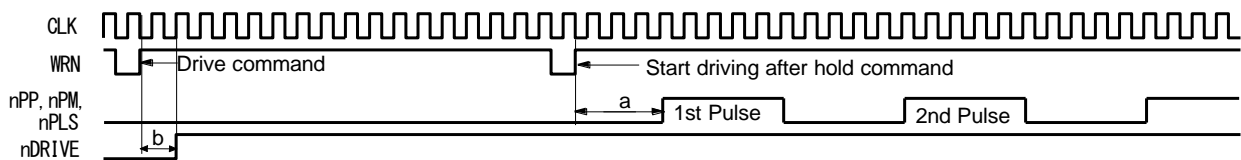

- a. The first pulse (nPP, nPM and nPLS) of each axis will be output after a maximum of 4 CLK cycles from WRN ↑ when a start driving after hold command is written.
- b. nDRIVE will become Hi level after a maximum of 2 CLK cycles from WRN ↑ when a driving command of each axis is written.

11.5 Instant Stop

The following figure illustrates the timing of instant stop. Instant stop input signals are EMGN, nLMTP/M (When setting the instant stop mode) and nALARM.

When an instant stop input signal becomes active, or an instant stop command is written, the output of pulses will be stopped instantly after the output of pulses being outputted.

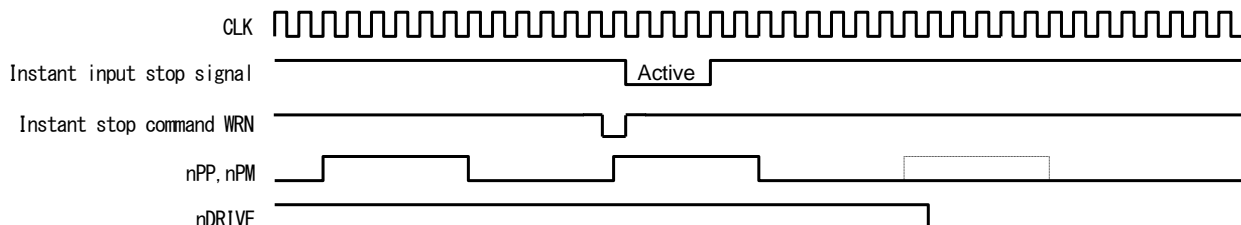

An instant stop input signal requires a pulse width of 2 CLK cycles or more even if the input signal filter is disabled. When the input signal filter is enabled, the input signal will be delayed according to the time constant of the filter.

11.6 Decelerating Stop

The following figure illustrates the timing of decelerating stop. Decelerating stop signals are nSTOP2~0 and nLMTP/M (When setting the decelerating stop mode).

When a decelerating stop input signal becomes active, or a decelerating stop command is written, decelerating stop will be performed after the output of pulses being outputted.

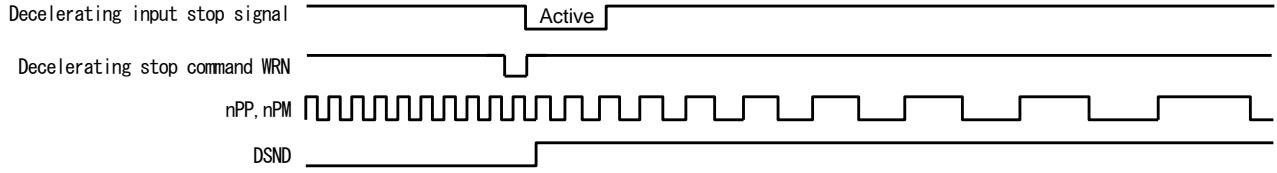

When the input signal filter is enabled, the input signal will be delayed according to the time constant of the filter.

11.7 Detailed Timing of Split Pulse

When with starting pulse is enabled in split pulse mode setting, only the first split pulse is on the Hi level at the timing of the drive pulse ↑. The second or later split pulses are on the Hi level after 1 CLK cycle from the drive pulse ↑. Therefore, the Hi level width of the first split pulse is 1 CLK cycle longer than that of the second or later split pulses.

When without starting pulse is enabled in split pulse mode setting, all the split pulses are on the Hi level after 1 CLK cycle from the drive pulse ↑ (when the positive logic is set).

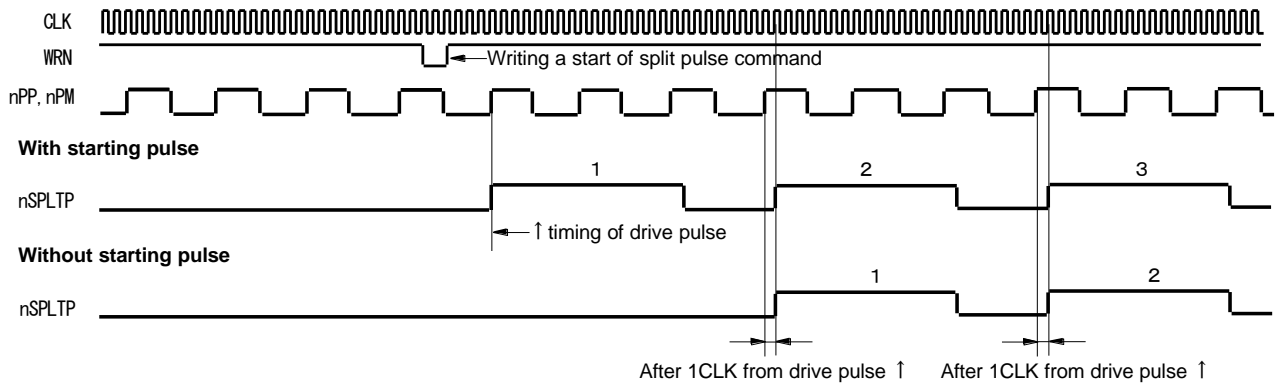

12. Package Dimensions

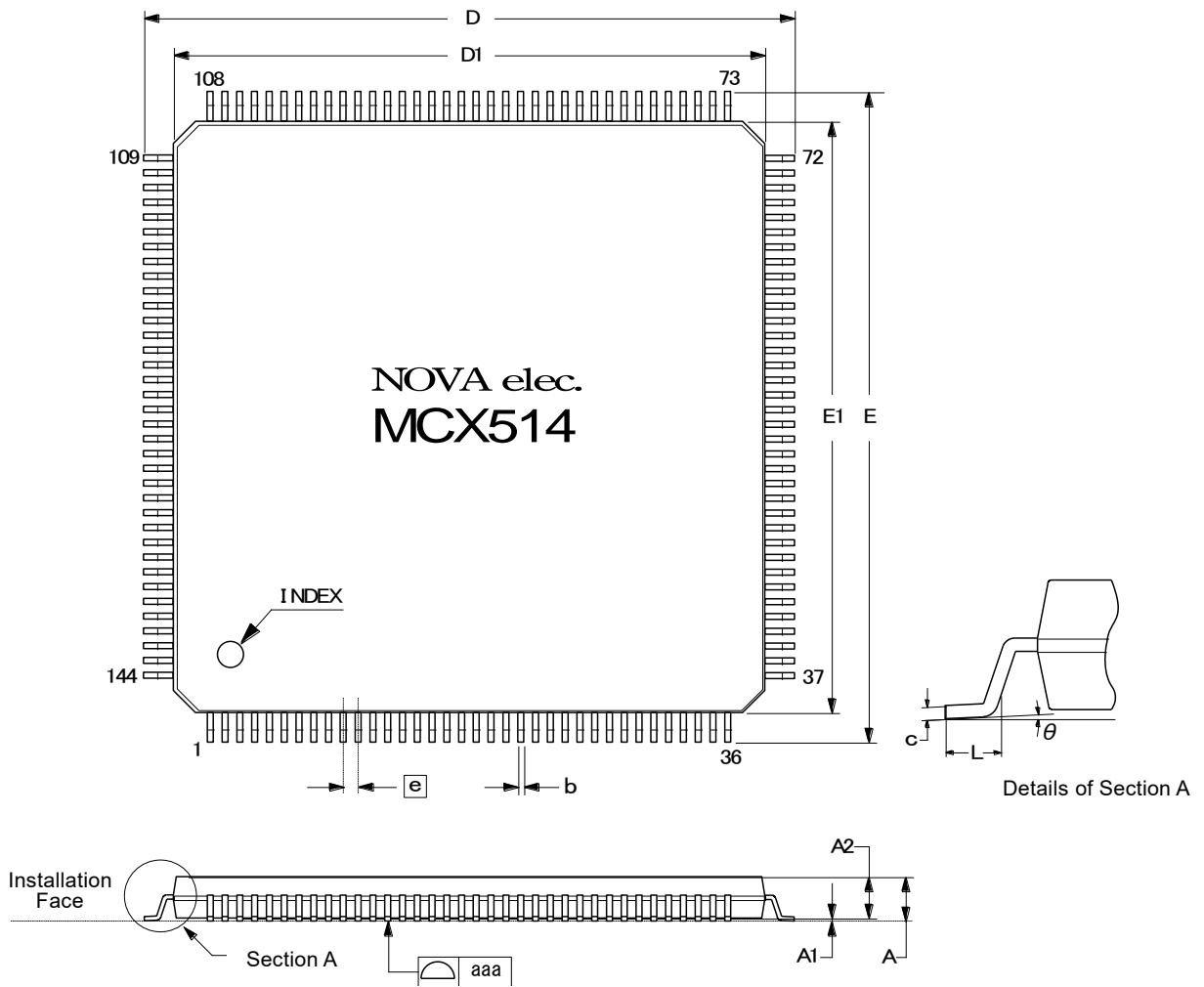

Package Size 20 × 20 × 1.4 mm

Symbol	Size (mm)			Description
	Min.	Standard	Max.	
A	—	—	1.7	Height from seating plane to the top end of package main unit
A1	—	0.1	—	Height from seating plane to the bottom end of package main unit
A2	—	1.4	—	Height from the top end to the bottom end of package main unit
b	0.17	—	0.27	Pin width
c	0.09	—	0.2	Pin thickness
D	21.8	22	22.2	Overall length including pin length
D1	19.8	20	20.2	Length of package main unit
E	21.8	22	22.2	Overall width including pin length
E1	19.8	20	20.2	Width of package main unit
e	0.5			Pin pitch
L	0.3	—	0.75	Length of the pin flat section contacting seating plane
θ	0°	—	10°	Angle of the pin flat section to seating plane
aaa	0.08			Uniformity of the bottom of pins (permissible value in the vertical direction)

13. Storage and Recommended Installation Conditions

13.1 Storage of this IC

Note the following items in regard to the storage of this IC.

- (1) Do not throw or drop the IC. Otherwise, the packing material could be torn, damaging the airtightness.
- (2) Store the IC sealed damp-proof package in the temperature 30°C or lower and humidity 85%RH or lower and use the IC within 12 months.
- (3) If the IC usage date has expired, remove any dampness by baking it at the temperature 125°C±5°C for 20 hours or more and 36 hours or less. The number of baking must not exceed two times. If damp-proofing is damaged before expiration, also apply damp removal processing.
- (4) Protect the device from static electricity before applying damp removal processing.
- (5) After opening the damp-proof package, store the IC in the temperature 30°C or lower and humidity 70%RH or lower, and install it within seven days. If the allowable storage period described above has been exceeded, baking must be applied before installation of the IC.

13.2 Standard Installation Conditions by Soldering Iron

The standard installation conditions for the IC by soldering iron are as follows.

- (1) Installation method: Soldering iron (heating pin section)
- (2) Installation conditions: The temperature of the pin: 350°C or lower, Time: 5 seconds or less, Number of times: 2 times or less

13.3 Standard Installation Conditions by Solder Reflow

The standard installation conditions for the IC by solder reflow are as follows.

Mounting Method	(1) Infrared (2) Hot air (3) Infrared and Hot air
Maximum reflow temperature (package surface temperature)	260°C or less
Time of over 250°C	10 seconds or less
Time of over 220°C	60 seconds or less
Time of 140°C~200°C (Preheating temperature)	60~120 seconds
Solder reflow count	Up to twice

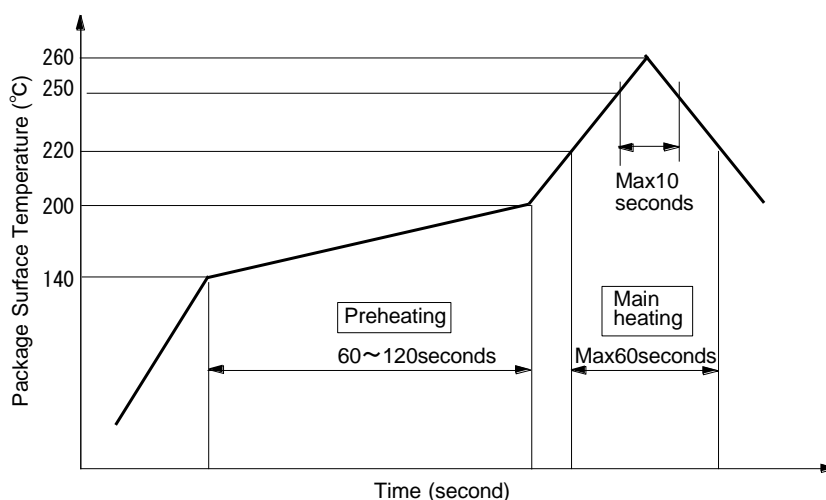

MCX514 Standard Soldering Reflow Heat-proof Profile

Appendix A Calculation Formula of Acceleration/Deceleration Drive

A-1 Case of Trapezoidal Acceleration/Deceleration Driving

(CLK = 16MHz)

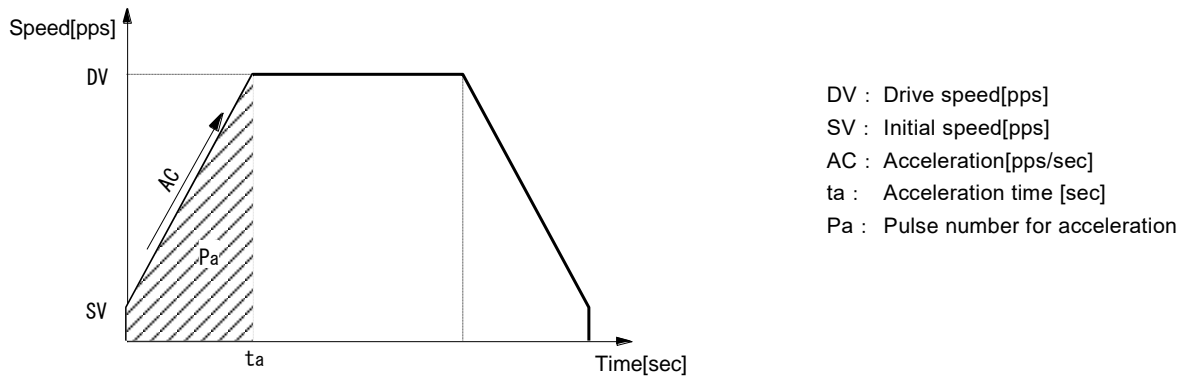

◎ Calculation Formula of acceleration AC when initial speed SV, drive speed DV and acceleration time ta are given

$$\text{Acceleration} \quad AC = \frac{DV - SV}{t_a} \quad [\text{pps/sec}]$$

◎ Calculation Formula of acceleration time ta when initial speed SV, drive speed DV and acceleration AC are given

$$\text{Acceleration time} \quad t_a = \frac{DV - SV}{AC} \quad [\text{sec}]$$

◎ Calculation Formula of pulse number for acceleration Pa when initial speed SV, drive speed DV and acceleration AC are given

$$\text{Pulse number for acceleration} \quad P_a = \frac{DV^2 - SV^2}{2 \times AC}$$

Deceleration DC, deceleration time td and pulse number for deceleration Pd can be calculated by replacing acceleration AC, acceleration time ta and pulse number for acceleration Pa with deceleration DC, deceleration time td and pulse number for deceleration Pd respectively.

[Note]

- The above calculation formula is an ideal expression and slight differences will be made in the actual IC operation.

A-2 Case of S-curve Acceleration/Deceleration Driving

(CLK = 16MHz)

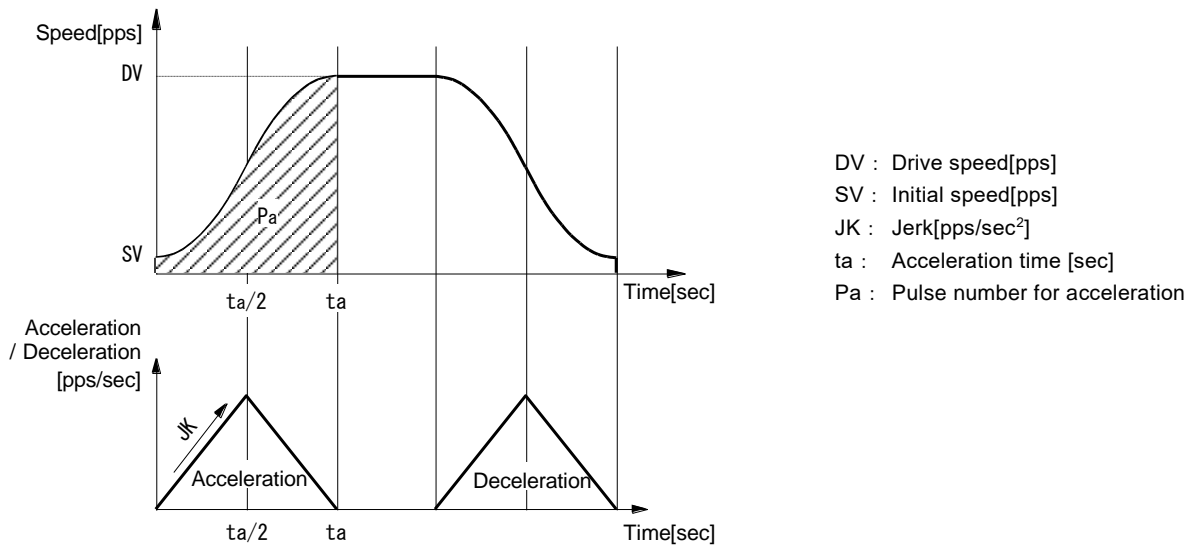

Acceleration AC is fixed to 1FFF FFFFh.

◎ Calculation Formula of jerk JK when initial speed SV, drive speed DV and acceleration time ta are given

$$\text{Jerk JK} = \frac{4(DV - SV)}{ta^2} \quad [\text{pps}/\text{sec}^2]$$

◎ Calculation Formula of acceleration time ta when initial speed SV, drive speed DV and jerk JK are given

$$\text{Acceleration time } ta = 2 \sqrt{\frac{DV - SV}{JK}} \quad [\text{sec}]$$

◎ Calculation Formula of pulse number for acceleration Pa when initial speed SV, drive speed DV and jerk JK are given

$$\text{Pulse number for acceleration } Pa = (DV + SV) \sqrt{\frac{DV - SV}{JK}}$$

Deceleration increasing rate DJ, deceleration time td and pulse number for deceleration Pd can be calculated by replacing jerk JK, acceleration time ta and pulse number for acceleration Pa with deceleration increasing rate DJ, deceleration time td and pulse number for deceleration Pd respectively.

[Note]

- The above calculation formula does not hold true in partial S-curve acceleration/deceleration driving.
- The above calculation formula is an ideal expression and slight differences will be made in the actual IC operation.

Appendix B Parameter Calculation Formula when Input Clock except 16MHz

When MCX514 input clock frequency is f_{CLK} (Hz), setting values of each speed and timer are as follows.

$$\begin{aligned}
 \text{Initial speed [pps]} &= SV \times \frac{f_{CLK}}{16 \times 10^6} \\
 \text{Drive speed [pps]} &= DV \times \frac{f_{CLK}}{16 \times 10^6} \\
 \text{Acceleration [pps/sec]} &= AC \times \left(\frac{f_{CLK}}{16 \times 10^6} \right)^2 \\
 \text{Deceleration [pps/sec]} &= DC \times \left(\frac{f_{CLK}}{16 \times 10^6} \right)^2 \\
 \text{Jerk [pps/sec}^2] &= JK \times \left(\frac{f_{CLK}}{16 \times 10^6} \right)^3 \\
 \text{Deceleration increasing rate [pps/sec}^2] &= DJ \times \left(\frac{f_{CLK}}{16 \times 10^6} \right)^3 \\
 \text{Home search speed [pps]} &= HV \times \frac{f_{CLK}}{16 \times 10^6} \\
 \text{Speed increasing / decreasing value [pps]} &= IV \times \frac{f_{CLK}}{16 \times 10^6} \\
 \text{Timer value [\mu sec]} &= TM \times \frac{16 \times 10^6}{f_{CLK}}
 \end{aligned}$$

[Symbol]

- SV : Initial speed setting
- DV : Drive speed setting
- AC : Acceleration setting
- DC : Deceleration setting
- JK : Jerk setting
- DJ : Deceleration increasing rate setting
- HV : Home search speed setting
- IV : Speed increasing / decreasing value setting
- TM : Timer value setting

Synchronous pulse output width (synchronous action), deviation counter clear output signal width (automatic home search), timer time between steps (automatic home search) and input signal delay time (input signal filter) require correction by using

$\frac{16 \times 10^6}{f_{CLK}}$ respectively.

Appendix C Differences with MCX300 series

Main differences between MCX300 series and MCX514 are as follows.

For details of functions, please refer to each description in this manual.

	Item	MCX300 series	MCX514
1	Treatment of unused input pins	Can open. (pulled up to VDD in the IC)	There are input pins not pulled up in the IC, which should be connected to VDD or GND. See chapter 5 for more details.
2	Width of reset signal (RESETN)	Requires more than 4 CLK cycles	Requires more than 8 CLK cycles
3	Command reset	Writes 8000h (D15 bit: 1) into WR0 register.	Writes 00FFh into WR0 register.
4	Setting of speed parameter	Speed range setting is provided. (multiple: 1~500) Speed parameter should be set based on the actual value and multiple.	No speed range setting (speed range-free) Speed parameter is set the actual value.
5	Fixed pulse driving	<ul style="list-style-type: none"> • + Direction fixed pulse driving Specifies output pulse number by positive value. When executed, it drives specified pulses in the + direction. • - Direction fixed pulse driving Specifies output pulse number by positive value. When executed, it drives specified pulses in the - direction. 	<ul style="list-style-type: none"> • Relative position driving Specifies output pulse number by positive value and when executed, it drives specified pulses in the + direction. Specifies output pulse number by negative value and when executed, it drives specified pulses in the - direction. • Counter relative position driving Specifies output pulse number by positive value and when executed, it drives specified pulses in the - direction. This is a driving command corresponding to - direction fixed pulse driving of MCX300 series. • Absolute position driving As the finish point of driving, specifies logical position counter value that is a destination point
6	RR2 register / Error information display (Software limit and hardware limit signal, alarm signal from a servo driver and emergency stop signal)	Even though driving stops, if error factor becomes active, error information bit becomes 1. And when error factor is cleared, error information bit returns to 0.	If error factor becomes active during the driving (or error factor is active at the start of driving), error information bit becomes 1 and will keep 1 even after error factor is cleared. If error factor becomes active while driving stops, it does not become error. All the bits of RR2 return to 0 by error/finishing status clear command (79h) or the start of next driving. However, when an error occurs during interpolation driving, it is necessary to write error/finishing status clear command (79h) after checking that interpolation drive stops.
7	Enable / disable of hardware limit function	Function of hardware limit signals (nLMTP and nLMTM) (LMT+ and LMT- in MCX305) cannot be disabled.	Function of hardware limit signals (nLMTP and nLMTM) can be enabled / disabled.
8	Setting of software limit value	Sets software limit value to compare register (COMP+, COMP-) Because of this, when using compare register as software limit, the other function of compare register cannot be used.	Sets software limit value to a dedicated register (SLMT+, SLMT-).
9	Stop type of software limit	Only decelerating stop	Selectable from decelerating stop or instant stop.
10	Trapezoid triangle form prevention	At reset: Disabled	At reset: Enabled
11	Acceleration counter offsetting	At reset: 8	At reset: 0

12	Command code and mode setting bit	—	Differs from MCX300 series.
13	Position and speed parameters setting for interpolation driving	When interpolation driving is performed continuously, and if parameters are the same as previous values, it is not necessary to set them again.	Before writing interpolation drive command, be sure to set position and speed parameters. When parameters are the same as previous values, it is necessary to set them again.
14	How to set 2-axis constant vector speed	Mode setting: Set to WR5/D8, D9	Mode setting: Interpolation mode setting command (2Ah) Set to WR6/D6, D7
		Speed range setting: Set the value that multiplies the range of main axis by 1.414 to the range of second axis.	Not required